

# Dragon Ball Z: Buu's Fury FAQ/Walkthrough

by SayainPrince

Updated to v1.1 on Feb 25, 2006

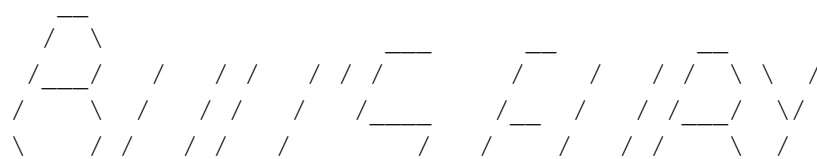
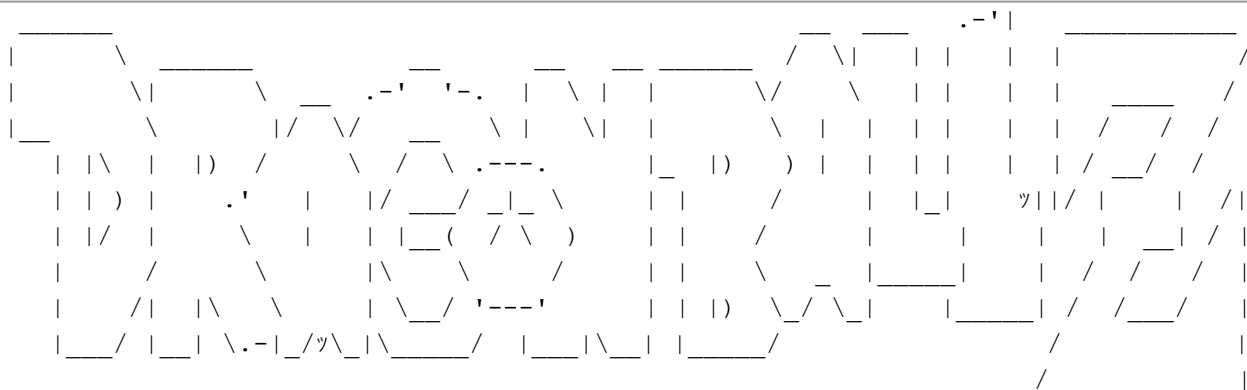

## Table of Contents

01.	Legal Disclaimer	[LEGAL]	lo
02.	Introduction	[INTRO]	lo
-----			
03.	Basics	[BASIC]	lo
03.1	Controls	[CNTRL]	lo
03.2	The Game Screen	[SCREE]	lo
03.3	The Pause Menu	[PMENU]	lo
03.4	Stat Descriptions	[STATD]	lo
03.5	Leveling Up	[LEVEL]	lo
03.6	The Scouter	[SCOUT]	lo
03.7	Gameplay Features	[GPLAY]	lo
-----			
04.	Walkthrough	[WALKT]	lo
05.1	Chapter 1 - The Other World	[CHP01]	lo
05.2	Chapter 2 - Great Saiyaman	[CHP02]	lo
05.3	Chapter 3 - World Tournament	[CHP03]	lo
05.4	Chapter 4 - Babidi	[CHP04]	lo
05.5	Chapter 5 - Majin Vegeta	[CHP05]	lo
05.6	Chapter 6 - Dragonballs	[CHP06]	lo
05.7	Chapter 7 - Majin Buu	[CHP07]	lo
05.8	Chapter 8 - Janemba	[CHP08]	lo
05.9	Chapter 9 - Super Buu	[CHP09]	lo
5.10	Chapter 10 - Fusion	[CHP10]	lo
5.11	Chapter 11 - Kid Buu	[CHP11]	lo
5.12	Chapter 12 - A New Beginning	[CHP12]	lo
-----			
06.	Technique List	[MOVES]	lo
06.	Scouter Entries	[ENEMY]	lo

```

|-----|-----|
| 07. Item List           | [ITEMS] |o
|   08.1 Supplies        | [SUPPL] |o
|   08.2 Equipment       | [EQUIP] |o
|   08.3 Hercule Exhibits| [EXHER] |x
|   08.4 Z-Fighter EXhibits| [EXZFI] |x
| 08. Shop List          | [SHOPL] |o
| 09. World Map          | [WORLD] |o
|-----|-----|
| 10. Credits            | [CREDS] |o
\y|_____|\y/
|_____|

```

And for the people who may not know about the search funtion: If you press the Control + F keys on your computer, you'll get a search dialog. Put in one of the keys you see on the right, and you'll be brought directly to that section. For example, if you wanted to go to the "World Tournament" Chapter, you would type "[CHP03]" and hit enter.

```

      .-""-.
     /  \  \
    /    \  \
   /      \  \
  /        \  \
 /          \  \
/            \  \
|-----|-----|
| 01. Legal Disclaimer   | [LEGAL] |
|-----|-----|

```

This file is intended for personal use. It may be reproduced, but only for personal use (i.e. printing it for a friend.) However, it may not be published on any website, magazine, or other production -- whether commercial or free -- without permission, which may be obtained by e-mailing me at GermanDragon[at]gmail[dot]com. As of now, the only sites that have this permission are as follows:

- [ ] [www.GameFAQs.com](http://www.GameFAQs.com)
- [ ] [www.IGN.com](http://www.IGN.com)
- [ ] [www.NeoSeeker.com](http://www.NeoSeeker.com)
- [ ] [www.TheGenie.Net](http://www.TheGenie.Net)
- [ ] [www.EvermoreForums.com](http://www.EvermoreForums.com)
- [ ] [www.GamerHelp.com](http://www.GamerHelp.com)
- [ ] [www.SuperCheats.com](http://www.SuperCheats.com)
- [ ] [www.CheatPlanet.com](http://www.CheatPlanet.com)
- [ ] [www.CheatHappens.com](http://www.CheatHappens.com)
- [ ] [www.1Up.com](http://www.1Up.com)

Copyright (c)2006 Chris Quigley

```

      .-""-.
     /  \  \
    /    \  \
   /      \  \
  /        \  \
 /          \  \
/            \  \
|-----|-----|
| 02. Introduction     | [INTRO] |
|-----|-----|

```

DragonBall Z Buu's Fury, is the third installment of the Legacy of Goku series. It picks up after the Cell Games, where Legacy of Goku 2 left off, and starts out in otherworld, with Goku and King Kai on Snakeway - Just like in the television show - And it will continue all the way through the end of the series. Fans will be happy to know, that it even includes a few enemies left untouched, in many of the past DBZ games. Namely, Broly and Janemba.

The game will allow you control a variety of characters, such as: Goten, Trunks, Gohan, Goku and Vegeta. You'll even control three different Fusion characters. All of the characters have their own KI - or energy - attacks that seperate them from everyone else. Along your adventure, you'll be leveling them up, and taking part in many of the important battles that you've seen in the show. All in all, it's a damn fun game.

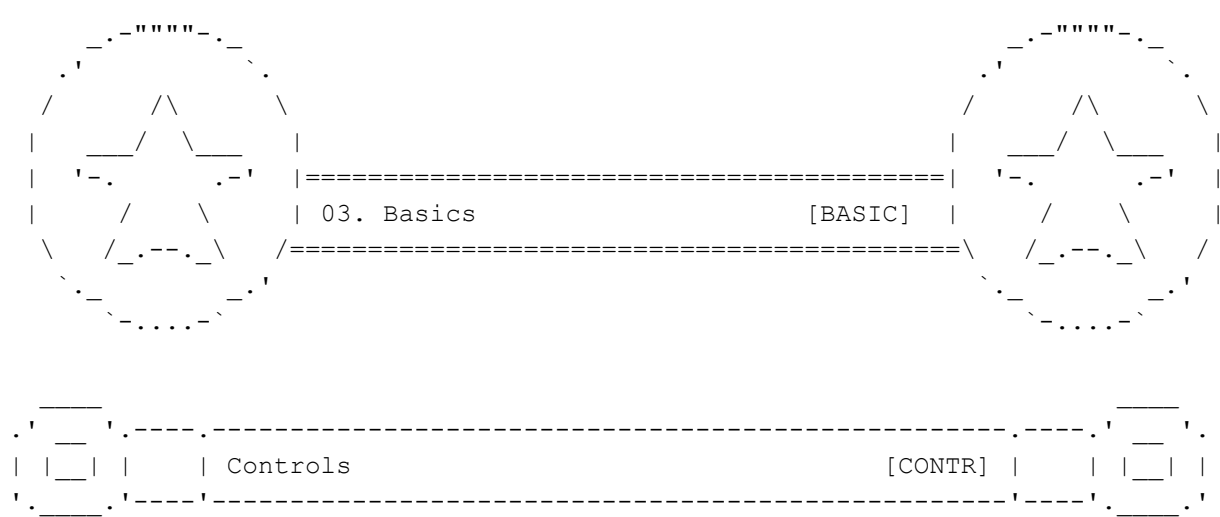

This section will be used to describe the controls, both with words, and with diagrams. It is divided into two halves, one for when you are on the World Map, and the other for when you are in battle, or exploring. It is necessary to have both of these, as their controls are completely different. The controls are as follows.

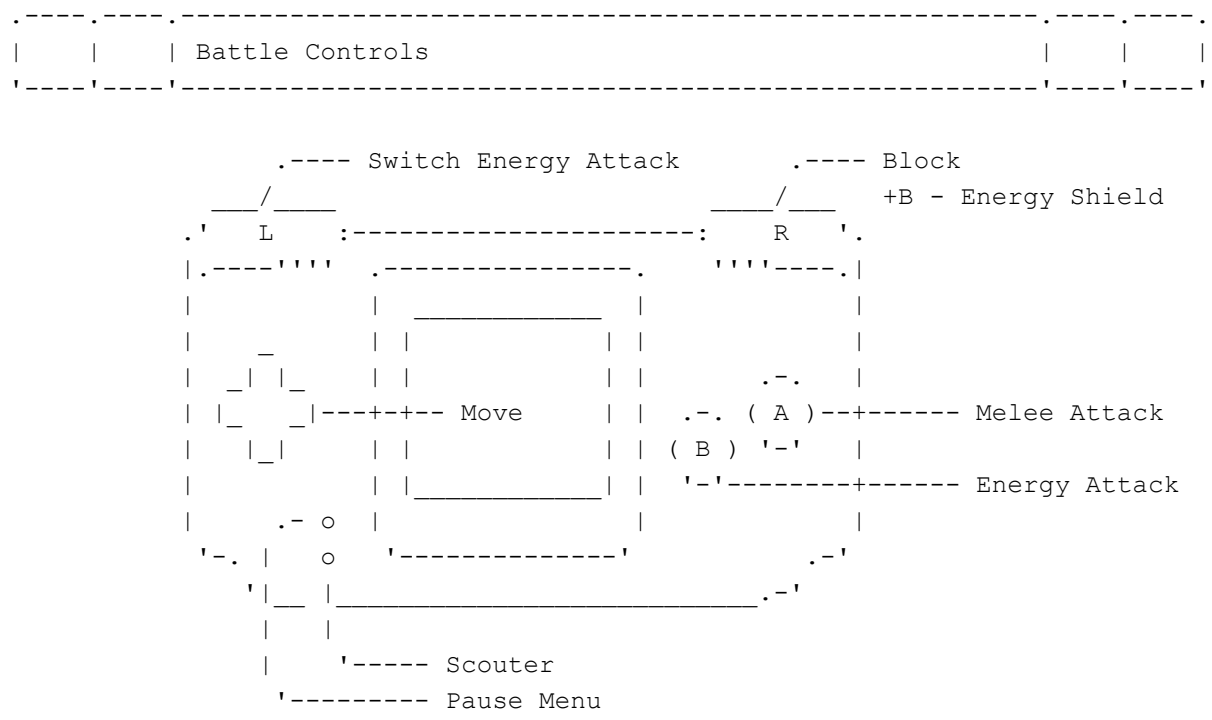

[A] This is your basic melee attack. This will be either a punch, or a kick, which is random. Both work in the same way, and will hit an enemy just in front of you. Occassionally, you'll get a critical hit and knock

the enemy back - Shown by yellow damage numbers, as opposed to the red ones for normal hits.

[B] This is your energy attack. Whatever technique you have selected - Shown in the HUD bar, in the upperleft hand corner of the screen - will be used provided you have enough energy - Also shown in the HUD. How each energy attack works, is different. You can read more about the different skills in Section 6, the Technique List.

[L] This will change your currently selected technique, shown in the HUD in the upperleft hand corner of the screen. This will be the technique that you can use by pressing the B button.

[R] This will cause your character to put their guard up. This will greatly decrease the damage you take from enemies' attacks. You can set up a stronger, energy shield by pressing B while holding R. This one will negate most attacks completely. This can be useful in some tough fights, but it's generally better to just try and avoid attacks. Note: Using the energy shield requires that you have some energy left.

[SLCT] This will activate the scouter screen. The Scouter can be used to gain data on the enemies around you, Or, if you are not engaged in a fight, it can act as a map - You can even check some data on people that aren't enemies. More information on the scouter can be found in section 03.6, The Scouter.

[STRT] This will open up the pause menu. From the menu, you'll be able to use items, upgrade your stats - if you have a level up - and use any items you may have collected, among other things. This also has it's own section: 03.3, The Pause Menu.

[DPAD] This is the simplest of buttons to use. If you press up, your character will move to the North. Down, will move them to the south, and the left and right buttons will move them east and west respectively. You can move diagonally by pressing it to an angle, and you can run by tapping it twice in the same direction.

```
.....
|      |      | Map Controls                                |      |      |
'-----'-----'-----'
```

```
          .---- No Use          .---- No Use
         ____/____          ____/____
        .'  L  :-----:  R  '.
        |.----'----'.-----'.----'.
        |          |          |          | | | | |
        |  _  |  |          |  |          |
        |  _|_|  |  |          |  |          |
        |  _  _|----+---- Move  |  |  .-. ( A )---+----- Ascend
        |  _|_|  |  |          |  |  ( B ) '- '  |
        |          |  |          |  |  '- '-----+----- Descend
        |          |  |          |  |
        |  .- o  |  |          |  |
        |  .- |  o  '-----'  .-'
        |  _|_|          |  |
        |          |
        |          |----- Scouter (When Searching for Dragonballs)
        |          |----- Pause Menu
```

[A] Pressing this will cause your character to fly higher into the air, giving you a broader view on the world around you. You can also





pressing L at the Options screen. On this screen, you can see your stats on the right side of the screen, and the items you have equipped on the left side. The items are divided into Body, Hands, Feet, and Accessories. When you move the cursor over the items, you get a description of them. When you press the A button on them, you get a chance to view all your equipment of that type, and you can move the cursor over the items in that list.

In that list, all the descriptions of the items are shown, and the stats of them are on the right. If a stat is green, it will benefit from the item. If a stat is red, it will go down due to the item. This holds true for all except REQLVL, or Required Level. If this is green, you can equip the level. If it is red, you must level up to the number shown, before you can equip this item at all.

Finally, next to each item in the list, that is equipped, is the letter "E". The color of the E represents who the item is equipped to. When you press A, on an item like this, you do not get to equip it to your current character, until you unequip it from the character shown. The characters and the colors they are represented by, are shown below:

- Orange - Goku
- Green - Gohan
- Dark Blue - Vegeta
- Purple - Trunks
- Goten - Light Blue
- Gotenks - Gray

```

.----.----.-----
|  |  | Options Screen          |  |  |
'----'----'-----

```

This screen can be accessed by pressing R at the Equip screen, or by pressing L at the Journal screen. Here, you can change the volume of Sound FX and Music, and change the speed of the message text. You can also view the game's Credits. Finally, you can enter Sleep Mode. This is a way to partially turn off your Gameboy Advance. The screen will go black, allowing you to save battery life, without turning the game off, for those moments where you can't reach a save spot. Press L, R, Start, and Select at the same time to turn your Gameboy Advance back on.

```

.----.----.-----
|  |  | Journal Screen          |  |  |
'----'----'-----

```

You can access this screen by pressing R at the Options screen, or by pressing L at the Status screen. Here, you can view your Goals, and Completed Goals. You can switch between lists by pressing left and right on the D-Pad, and you can scroll up and down on the lists, by pressing up and down on the D-Pad.

Now, next to each goal, is a star. This star actually has significance. A bright yellow star, means that the quest was a Main Quest, that was required to be completed, if you want to beat the game. A darker brownish star, means that the quest was an optional, and from what I can tell, a gray star means the quest was a side quest, that you have no choice but to complete.

```

.----.----.-----
| |__| |  | Stat Descriptions          [STATD] |  | |__| |
'----'----'-----

```









King Yemma's Office.

Walk forward, and press the A button, while facing the front of the huge desk, and Goku will talk to the giant, King Yemma. After a short conversation Yemma will tell you that the Higher Plane is through the door to your left. Go and talk to the blue man sanding in front of it, and he'll allow you to pass through. Go through the door, and head to the right, past the first set of stairs, which lead to Heaven, an area you can't go to yet. Head up the stairs on the right, and you'll talk to King Kai. Soon, you'll board the plane, and be headed to the Grand Kai's Mansion.

```
.-----.  
|      | Grand Kai's Planet      |      |  
'-----'
```

As soon as you land, you'll have another short conversation with King Kai, and then he'll basically tell you to do your own thing. The first thing you should do, is stand on the circle where you landed, which bears the Capsule Corp logo, and press A. You'll be able to save, and later on, switch characters with these circles. Save now, and get used to doing it often. After you've saved, head south, off of the screen.

You'll meet Olibu on the next screen. When the introduction is over, you can walk around and get some basic gameplay tips from the fighters. After you have a basic understanding of how to fight, walk along the street, until you meet Olibu again. Don't talk to him just yet, though. Stray off the path a bit, and onto the grass, a bit south of him. There are two treasure chests here, one with the [1 TON BOOTS] and the other with the [1 TON ARMBANDS]. These items will make oyu move slower, but allow you to gain more EXP in your fights. You can choose whether or not to wear them, and when you are ready, talk to Olibu. He'll tell you that the Battlefield Royale is ahead. When he asks you if you're ready for the challenge, answer yes, then head to the right.

On the screen on the right, you'll be greeted by two Fighters, who call you a rookie. Punch them both out, then head along the path, to the next screen, where three more fighters will call you a newbie - That's even more insulting than "rookie" - Once again, kill them with punches. By this time, you should have leveled up; Especially, if you have the 1 Ton Armbands and Boots on. When you get one, make sure to go to the pause menu, and upgrade your stats. Head to the right side of the screen, and head down, between the two trees. There are four Fighters on the next screen, and they'll be starting to show you some respect, but you still want to kill them. You can just take them out with your fists too, then head off the screen to the right, where you will meet Olibu again. This time, he's looking for a bit of sparring though!

```
.-----.  
| OLIBU          | Olibu really isn't much better than a Supped-up |  
|-----| Fighter. He doesn't even have any energy attacks |  
| HP: 565        | so basically, he'll be walking, and trying to   |  
| STR: 15        | punch you. If you just stand in front of him,   |  
| POW: 0         | and put all your energy into a Kamehameha, you   |  
| END: 21        | can take more than three-fourths of his health  |  
|-----| away. Then, you can just walk up, and punch him |  
| a few times, to deal the final damage needed to kill him. Hell, if you |  
| used your energy on the Fighters on the Battlegrounds, this strategy can|  
| even work, starting from when he has full health.                        |  
'-----'
```

After you defeat Olibu, he'll walk through the Character Gate, with an orange



| like the first. Stay close and keep hitting him, before he gets a chance  
| to retaliate. If you want to make things easier, knock him to a side of  
| the arena (as neither of you can fall out) and then, hit him, quickly  
| followed by a Kamehameha. If you do it fast enough, he won't have any  
| time to block, or any space to move, allowing you to quickly damage him.  
'-----'

When the fight ends, you'll see a cutscene, of Goku and Pikkon taking the  
fight into the air - and to the ceiling. Goku will be victorious, but as it  
turns out, the fight will be a draw, because both fighters touched the  
ceiling - Which according to the Grand Kai, is just as bad as touching the  
floor. After that, the chapter will end.

```
.' '-----'.  
| | | Chapter 2 - Great Saiyaman | [CHP02] | | |  
'-----'.  
.' '-----'.
```

```
-----  
| | | East District 439 | | |  
'-----'.
```

When Chapter 2 begins, you'll be playing as Gohan, back on Earth. Leave the  
kitchen, and walk around, through the parlor, and go up the stairs. You'll  
find yourself in an upstairs hallway. Go through the door on the north wall,  
and you'll enter Gohan and Goten's room. Check the toybox near the bed, to  
find a [Z-FIGHTER EXHIBIT]. This is one of the exhibits, that can be put on  
display in the Capsule Corp museum. After you have the exhibit, leave the  
room, and take the door on the south side of the hallway. Open the chest  
near the door, to find a [LAZARUS CRYSTAL]. This will revive you, when you  
die, so it's very helpful. After you have both items, go back downstairs,  
and leave the house, through the door on the south wall, in the parlor.

As soon as you get outside, make sure to save on the Capsule Corp logo. When  
you're good to go, walk south until you reach the bridge, and Chi-Chi will  
stop you. she'll give you a [RICE BALL] and a carton of [MILK] which may  
come in handy during battle, and then Gohan will call his cloud, the Flying  
Nimbus. When you're ready to head on to Hercule City, your next destination  
simply get on the cloud. You'll be instantly brought to Hercule City.

```
-----  
| | | Hercule City | | |  
'-----'.
```

After arriving in the city, you'll be told to go to Orange Star High School.  
There are a number of things you can and should do first. For example, the Z-  
Mart is right above where you land. Although most of the equipment and items  
for sale here, are probably too expensive for you right now, it can be a  
good thing to familiarize yourself with the place. When you are done looking  
around at the store, head to the right. There's an armed robbery going on,  
so your sight seeing is about to take a back seat ride, but you'll get back  
to that, after you solve this problem.

After a few threats from the robbers, Gohan will transform into a Super  
Saiyan. It will be quite easy to dispatch them with a few punches while in  
this form, so go for it. When they're dead, a few onlookers will arrive,  
just in time to see that Gohan has flown off. He'll come back, unnoticed, in  
his regular form, just as Videll appears. Gohan will say he didn't see anything  
happen. She'll learn about the "Gold Fighter" that just stopped the robbery.





Once again, gohan, Videl, Erasa, and Sharpner will be talking in the back of the room, about a sperhero - This time, it will be Saiyaman of course. Soon, Videl will run off, to stop a gang that is causing trouble, and then Gohan will run off after her. When you get control of him, you'll be in the school's hallway. Leave, and save at the savepoint just outside the building, then head south, off of the screen. Here, you'll see the Red Shark Gang, with the Mayor. You'll also see Videl arrive. Walk to the action, and Gohan will transform into Saiyaman again. The biggest dude there (descriptively titled Thug) will punch out Videl, leaving the fighting to you.

First of all, you'll notice that the Thug isn't alone. He has two Gunman, a Bomber, and a Mercenary with him. Because they have guns, and he only has a steel pipe they are te bigger threat, even though he's stronger. So, run around him, and take them out one at a time - Preferably taking out the Bomber as quick as possible. When the Thug is the only one left, stay above him, and punch him in the face as quickly as possible, and back up if he gets close to you. Alternatively, you can blast him with a Kamehameha. When the fight ends, Videl will come back on screen, and Saiyaman will fly off.

```
.-----  
|      |      | Musuka Circus      |      |      |  
'-----'
```

On the next screen, you'll see a crowd of people around a caged dinosaur. As it turns out, Gohan recognizes him as Chobi, the baby of a family of pterodactyls that live near Gohan. The circus own will not listen to Gohan, so once again, violence is the solution. Head off of the screen to the left to reach Musuka Circus, then head up, to the right of the big tent, past the brick wall. There's a Mercenary, and a Criminal here, punch them both out, and head around the two crates, where you'll find another Criminal and a Bomber. When they're both dead, head north, to the next screen.

There's a bunch of Gunman and Criminals in that area, but they're all behind a couple of crates. What you should do, is walk around the crates to the left, and punch the Gunman and Criminals that attack, knocking them back. Then, take them out as a group with a Kamehameha. After that, walk around the crate, and kill the remaining Gunman. After that, move north one more screen, reaching the opposite side of the circus tent, where you'll see Chobi being guarded by three Thugs.

Turn Super Saiyan as soon as you enter the screen, then get closer to the first Thug. Use Gohan' Masenkoha to damage him, then give him a few punches to kill him - Do the same for the second Thug. By this time, you should be almost out of Super Saiyan energy. Power down to your normal mode, and hit the last Thug with a Masenkoha made of your base energy, then punch him a few times to finish him off. Note, that if you have no energy for this fight, you can get away with punching a thug three times, then backing off while he swings, and then going back to hit him again. Although, you should have a few items that restore EP by now anyway.

When the Thugs are gone, go up to Chobi's cage, and press the A button. Gohan will transform into his Saiyaman costume again, and take Chobi's cage. Walk around the left side of the tent, and head down one screen. There will be a Mercenary facing away from you - Go up behind him, and punch him out. As you do this, a Gunman and a Bomber will notice you, and attack. Go and punch out the Gunman, then do the same to the Bomber - Who will be next to a Criminal that you can kill, who hasn't even noticed you yet. When they're all dead, head south again, to the next screen.

On this screen, before you even have time to breathe, two Criminals will



begin throwing punches at you. Take out the one on the left first, then kill the one on the right. Walk towards the botrtom of the screen, and you'll find three more Criminals loitering around the wooden crates. Punch them all out, then head off the bottom of the screen, reaching the front of the tent again. Run towards the exit, back to Hercule city, and the Musaka, the circus owner, will appear and shout for help. A Tank will then appear, as Musaka runs away.

The Tank is pretty strong, and it's definitely durable, but it's stationary, making it an easy target. Stand in front of it, just below it's main gun, and it won't be able to hit you at all. Just keep punching it until it explodes, at which point three Criminals and a Bomber will come out. If you fire a nicely aimed Kamehameha, you can kill all four of them, before they spread out, but if not, you can punch them out as you normally would. When they're all dead, head to the right, back to Hercule City.

```
.----.----.-----.-----.-----.-----.-----.-----.-----.-----.-----.
|      |      | Hercule City                                     |      |      |
'-----'-----'-----'-----'-----'-----'-----'-----'-----'-----'
```

When you are back on the city's streets, head to the right. You'll find you are greeted with a Gunman, and another Tanks - And this ones moves! It still isn't that hard of a battle though. Fire your Kamehameha at the Tank until it explodes, then punch out the Criminals and Bombers inside. Head to the right from there, and kill the Mercenaries and the Gunman that are on the street. When all the enemies are killed, head south one screen, and follow the street until you reach the Capsule Corp save point.

Videl will be here waiting for you, and she'll accuse you of being a criminal. When a shadow of two giant angry pterodactyls fly by, however, she will start singing a different tune. Gohan will set Chobi free, and Videl will trick Gohan into revealing his identity. She'll tell Gohan that she'll keep the identity a secret, if he agrees to fight in the Worlds Martial Arts tournament, which he will. After that, Videl will leave. Use this time to save, then use the flight pad. Gohan will be contacted by Goku, who will tell him how he is allowed to come back to the earth for 24 hours, to fight in the tournament. After that.

Gohan will fly to the world map, and you'll be told you have to go to several areas, to tell people about the news. In reality, the only person you need to go and tell, is Chi-Chi, at East District 439, marked by a star on the map. The locations of the other people (West City, Roshi's Island, and Kami's Lookot) are marked with purple dots. You can go and tell them the news, if you want your journal to be complete, but don't expect a reward, because there isn't one. This FAQ will continue at East District 439, so if you wish to spread the word, do so, and continue reading once you are back at East District 439.

```
.----.----.-----.-----.-----.-----.-----.-----.-----.-----.-----.
|      |      | East District 439                               |      |      |
'-----'-----'-----'-----'-----'-----'-----'-----'-----'-----'
```

When you land, you can save if you want, and then walk into the house. Gohan will tell Chi-Chi about how Goku is coming back. He will then convince her to let him enter the tournament as well. When she leaves the room, Goten will ask if he can help Gohan train, to which, Gohan will answer yes. After that, the screen will change to Goku in King Yemma's Office. A quick cutscene of Goku being brought back to Earth with Babba, and then a foreshadowing of a problem in HFIL will be shown. King Yemma will send Pikkon down to check it

out, and Pikkon will mutter "Janemba". Then, the chapter will end.

```
.' _ ' .-----.' _ '.  
| | | | Chapter 3 - World Tournament [CHP03] | | | |  
' _ ' .-----.' _ '  
  
-----  
| | | | East District 439 | | | |  
' _ ' .-----.' _ '
```

This chapter starts outside of Gohan's house. Goten and him will decide to train, out in the eastern forest. Goten will run off, leaving you to get there on your own. That's not a problem, there are a few nice items along the way, in the forest, that you wouldn't want to miss. So, cross over the bridge to the south, and head right. There will be two Criminals for you to punch out, so do that, and head into the forest on your right.

On the next screen, there's a Gunman. Punch him out before he can shoot you, then head north on the path to the right (the one on the left is a deadend.) Near the top of the screen, is a Bomber concealed in the bushes, so be ready to kill him, then head off the top of the screen. As you enter the next screen, head around the cliff to the left, and kill a Criminal - But keep moving, because there are bombers on the cliffs throwing bobms at you! After walking around the first cliff, you can go and punch the Bomber, and a Criminal that will come at you. Then, walk around the second cliff, and kill another Bomber. From here, you have two paths: North and East. Goten is to the north, past a level 65 Character Gate, so remember that. For now, we are going to the east in search of items.

As son as you appear on the next screen, to the east, two Criminals will be in your face. Punch them out, then get out of the way, as there's a Gunman, who is very likely to be aiming his gun at you by now. Either punch him out, or use an energy attack on him, and head off the screen to the south and you will enter a screen with no enemies or items on it. Head to the right from here.

On this next screen, head to the right and kill the Mercenary, and then to the north, to kill a Criminal. When they're gone, you'll be free to use the save spot, and then head to the bottom of the screen, where you'll find a Criminal - Kill him. Now you'll find yourselfs with two paths. To the right is a level 140 Character Gate, that you don't even need to be at until much later in the game. So, head to the left, to a screen with a cliff with two Bombers on it. Run around the cliff and kill them both, then head to the screen to the south.

When you enter the screen, go Super Saiyan, because it will make these next few screens much easier. Run into the group of three Criminals to the south of where you enter, and take them all out, then head off the screen to the south. You'll appear on a screen next to a Gunman - Using your SSJ strength, take him out with a few punches, and head left. As soon as you enter this screen, you'll be near a Mercenary and a Criminal. You guessed it - You're going to kill them! When they're gone, head to the northwest part of the screen, and kill one more Criminal and a Bomber. After that, it' time to actually get one of the items we came for. Press A behind the tree with blue berries on it, that's right where you are, and you'll find a [HERCULE EXHIBIT]. Once you've got the exhibit, head west, off of the screen.

Kill the one Mercenary on this screen, and head south. Hopefully, you still have some Super Saiyan energy left, because this screen has two Gunmen and

two Criminals clumped together - And a Bomber just past them. You can either toss a couple Masenkohas or a Kamehameha, or take them out with your fists. Either way, when they are dead, open the treasure chest, to find a [REFLECTIVE TUNIC]. After that, you should be at least level 65 - If you weren't already - so equip your item, and go back to the level 65 Character Gate you saw earlier and go through it. Here, you'll meet Goten.

Talk to Goten, and Gohan will suggest a training exercise. Goten will be throwing rocks around the screen, and Gohan will have to dodge ten in a row. A good strategy for this, is to wait for him to throw the first one, and dodge it, then quickly get away from the wall, to the open area to the left of Goten, so you have more room. Then, move back and forth at a diagonal, from the open space to the wall, while he throws rocks. When you dodge ten in a row, talk to Goten. Goten will transform into a Super Saiyan, and you and him will do some sparring.

```
.-----'.-----'.
| GOTEN          | Goten isn't that strong of a fighter, and he is |
|-----| pretty slow in this fight. Just punch him a few |
| HP: 1050      | times, and once he reaches about half health, |
| STR: 10       | you can unleash your Kamehameha on him, until he|
| POW: 7        | loses all of hi health - Or you run out of EP, |
| END: 20       | at which point you can go back to punching him. |
|-----| ' Also, you don't have to worry about Goten using |
| any energy attacks. Although his POW attribute is above 0, he strangely |
| enough only attacks with punches and kicks. After the fight, you will |
| gain control of Trunks, who is in the gravity chamber with Vegeta. |
|-----| '
'-----'
```

```
.-----'.-----'.
| | | Gravity Chamber | | | |
|-----|-----|-----|-----|-----|
'-----'
```

In the Gravity Chamber, Trunks and Vegeta are training. When Trunks goes Super Saiyan, Vegeta is both shocked and aggravated. When Trunks asks if he can enter the world tournament, Vegeta says that if Trunks is able to hit him, that he will be allowed to complete. Here, you will gain control of Trunks, and you'll have to hit Vegeta. During this training session, Trunks's Sper Saiyan power will come and go. When it's gone, you will walk extremely slowly, and have little chance of hitting Vegeta. So, what you must do, is wait until you are a Super Saiyan, and then run at him. Note, that if he is blocked into a wall, he will fly over you, and you won't be able to hit him. The best way to hit him, is to chase him into a wall, and as soon as he lands behind you, begin running towards him, and punch him just before he reaches another wall. It seems you even have a better chance of hitting him when you run at an angle. After the training session, Vegeta and Trunks will go to the park in West City.

```
.-----'.-----'.
| | | West City | | | |
|-----|-----|-----|-----|-----|
'-----'
```

Trunks and Vegeta will land at the park in West City, and Vegeta will explain how you can use the Save and Switch Character to pads, to change your character. You will then be able to go and train as Vegeta suggests or go east to the Capsule Corp complex, and talk to Bulma, who will be standing outside. Since there really isn't much to do around the city, it may be best to just talk to her. When you do, she'll ask you if you want to go to the World Tournament. Say yes, and all the Z-Fighters will board the jet. Soon, everyone will get off at Papaya Island.



```
| STR: 13          | him to one of the sides of the arena, and keep |
| POW: 0          | him there with your punches, until he runs out |
| END: 28         | of HP. When this happens, you'll move on to the |
|-----' sixth round, and find yourself having to face a |
| few more of the normal humans - You'll also get to see his mother whine. |
|-----'
```

```
.-----'.-----'
| HUMANS          | Just like the first four rounds of the |
|-----' tournament, you'll be facing normal humans. You |
| HP: 850         | will face them up through the ninth round, so |
| STR: 11         | that's another four humans. Use the same |
| POW: 0          | strategy you did before, until they're all gone. |
| END: 25         | At this point, you will enter the tenth round, |
|-----' with Goten. |
|-----'
```

```
.-----'.-----'
| GOTEN          | For some unknown reason, Goten's STR and END are |
|-----' lower than the Humans. Oh well, that will just |
| HP: 1050        | make the fight easier. As for the strategy, |
| STR: 10         | first make sure to use any stat points you may |
| POW: 7          | have earned in the previous rounds. When that is |
| END: 20         | done, go at Goten with your fists, backing him |
|-----' up against a wall if you can. After you nearly |
| defeat him, Goten will transform into a Super Saiyan claiming he forgot |
| the agreement. Trunks will then go Super Saiyan as well. At this point, |
| Goten's HP will have been refilled, and he will be stronger - However, |
| he still won't be using energy attacks. Punch him hard and fast, until |
| he is about one-fourth of his health, then you can take him out with |
| some style, by unloading a Flame Kamehameha - Or you could just punch |
| him around some more. |
|-----'
```

After Goten is defeated, Trunks will be declared the Junior World Champion. He will then be told he is having an exhibition with Hercule. Hercule will both try to escape, and get Trunks to throw the match, but to no avail. Wait for the "match" to start, and then just hit Hercule - He will not only lose all of his health, he'll be flung out of the arena. Unfortunately, the crowd will think he let Trunks win. After that, the adult division of the tournament will start, and you will gain control of Gohan. Take this time to save, then talk to the Monk standing near the door, and tell him that everyone is ready.

You will see a cutscene, of a fight of Krillin beating Pintar. Then, Piccolo will step into the ring with Shin. Piccolo will be feeling uneasy about the match, and will ultimately throw the match, as if he knows something about Shin. After that, Piccolo will go out back again and Shin will follow. Shin will then reveal himself as the Supreme Kai. After that, Videl will enter the ring with Spopovich - And for the only time in the game, you will take control of Videl!

```
.-----'.-----'
| SPOPOVICH      | Had you used the Scouter on this guy in the |
|-----' back room of the stadium. It is especially low |
| HP: 225         | when compared to his partner Yamu. As soon as |
| STR: 15         | this fight begins, you will quickly understand |
| POW: 0          | that the only reason for this, is that you are |
| END: 25         | playing as Videl. Also because of this, you do |
|-----' not have much choice of strategy; Videl has no |
```

| energy attacks. Just try to stay above him, and punch his head, as fast |  
| and as often as you can. He'll have a harder time punching you when you |  
| are above him, instead of below him or to the side. After you deliver a |  
| beating to him, he will fall, but then get off the ground. His health |  
| will restore, with the arrival of evil music. Do the same tactics you |  
| did last time, until he reaches half health. At this time, he will |  
| completely annihilate Videl in a cutscene, ending the fight. |  
'-----'

.-----.  
| | | Papaya Island | | |  
'-----'

Right after the fight, Videl will be brought to a bed to rest, and Gohan and Hercule will be visiting her. Gohan will run back to the entrance of the tournament building, where he will meet Goku. Goku will agree to go and get some Senzu beans from Korin, and Gohan will go back inside. As Gohan, run to the south, until you reach the ship, and use the save pad to the left of it. Then, get on the World Map Circle, and head for Kami's Lookout on the world map.

.-----.  
| | | Kami's Lookout | | |  
'-----'

When you reach the lookout, head to the left side of the area, and press A on the flight pad. Goku will fly down to Korin's Tower, where Korin and Yajirobe are standing. Talk to Yajirobe for a Senzu Bean (And then, talk to him two more times for a total of three - Two for yourself!) You can also talk to Korin, who will ask you for fish. This is completely optional, but he will pay you for them. And if you ever give him a Red Snapper, he will give you a [Z-FIGHTER EXHIBIT]. Also, before you go, walk clockwise around Yajirobe three times. He will drop a [Z-FIGHTER EXHIBIT] off of the tower by accident! You can't get it yet, but you'll find it later, when you arrive at that area. After doing this, use the flight pad again.

You'll be back on the top of the lookout again. Before you leave, walk to the north, where there is a row of four trees. Press A while facing the third tree from the left, and you will find an invisible treasure chest, containing yet another [Z-FIGHTER EXHIBIT]! After you have it, you can go and use the World Map Circle again. Fly back to Papaya Island.

.-----.  
| | | Papaya Island | | |  
'-----'

When you are back on Papaya Island, run forward, to the entrance of the stadium. Goku will give the Senzu Bean to Gohan, and Gohan will take it to Videl - Despite Hercules whining about it being dangerous. Gohan will then go to participate in the tournament, while Videl instantly recovers as expected. Gohan is scheduled to face Kibito.

When Gohan gets in the ring, he will realize he forgot his helmet. This is quickly forgotten when Kibito asks to see his Super Saiyan powers, though. Gohan will transform into a Super Saiyan, and then bring it up to Super Saiyan 2. At this moment, Yamu and a powered up Spopovich will jump into the ring to attack Gohan, and you'll be in a two-on-one fight.

.-----.  
| SPOPOVICH & YAMU | Finally, you will see Spopoviches true colors, |

```

|-----| and, after doing so, you will notice that Yamu |
| HP: 1855/1476 | is actually the stronger one. Walk around them, |
| STR: 22/20 | so that Yamu is between you and Spopovich, then |
| POW: 0/0 | hit him with a few melee attacks. If Spopovich |
| END: 25/23 | manages to get around him, try to walk around a |
|-----' bit more, to "realign" them. Once Yamu runs out |
| of HP, he will fall to his knees, making the fight a one-on-one with |
| Spopovich. You can either turn this into a fist fight like you did with |
| Videll, or use a couple Masenkohas on him, as he's slow. If you choose |
| that method, you may have to deliver some punches to finish him off, |
| though. Eitherway, you'll win the fight. However, Yamu and Spopovich |
| will both attack him afterwards, in a cutscene, and steal his energy. |
|-----'

```

After the fight and the cutscene are over, the Z-Fighters will fly off, in search of Yamu and Spopovich. Then as Gohan gets up, he will follow them, after telling Videll about how he was the one who really defeated Cell. While in the air, Gohan will converse with Kibito, and he will learn about the history of Bibidi, Babidi, and Buu (No pun intended...) After that, they'll catch up with the rest of the Z-Fighters, and the chapter will end.

```

.' '-----.'
| | | Chapter 4 - Babidi [CHP04] | | |
'. '-----'
.-----
| | | Southwest Forest | | |
'-----'

```

As soon as you land, Supreme Kai will tell you that you have to search for Babidi's space ship. After that, you'll also gain the ability to switch to Goku and Vegeta. Switch to Goku for now, and head to the screen to north. On this screen, walk upwards, until you find a level 70 character gate. If you are at level 70, no problem. However, if you are not, fly back to East District 439, as Goku. It is currently the best place you have available, to train at. Once you are at a high enough record, smash the gate down, and head to the north again.

On the next screen, kill the Majin Fighters as you head to the north-west exit of the screen. There, you'll find three more Majin Fighters; Defeat them, and head north once more. On the next screen, you'll see a level 120 character gate on your right, for Vegeta. You can't get through it now, so go left. Continue to fight your way through this screen, and then through the next as well. You will then reach an area, with some dirt terrain -- And if you've caused Yajirobe to drop it already, you'll see Z-Fighter Exhibit 12 in front of you.

Make your way onto the rocky ground, and fight a few more Majin Fighters, then head north, watching out for the gunfire of the Majin Soldiers. There's a large rock, but it doesn't matter which way you go around it; Both sides lead to the next place, which is the screen to the north. Be prepared as you enter it though, because the incredibly strong (for your current level) Destroyer is standing on the other side, waiting to use his flamethrower attack on you. To take him out, stay near his left foot, which is his blind spot, and back him up into the wall. Then, either keep punching him, or let loose a Kamehameha. When he dies, head north yet again. There are a few more Majin Soldiers and Fighters there, but nothing to bad. Take them out, then head to the next screen on the right, and head north again, to the top of the screen. There's a capsule corp logo there, where you can save.









switch you have, and you'll see a cutscene of another door opening. Walk back two rooms to the east, then head south, to reach the door. Walk through it, and use the Save Circle, then head off the screen to the south. On the next screen, Dabura will show up, and it will be Gohan's turn to fight. And of course, the arena will change first...

```
-----  
| | | Demon World | | |  
'-----'
```

```
-----  
| DABURA | Dabura has a huge amount of HP, but he isn't too |  
|-----| strong, or fast. He does have a few specials to |  
| HP: 10000 | watch out for though. The first, is when he |  
| STR: 22 | gets into a meditation position, and floats into |  
| POW: 5 | the air. He then begins to unleash a forcefield |  
| END: 51 | that expands rapidly. Just stand far away from |  
|-----| him to avoid that. He may also begin laughing; |  
| He'll follow that up by spitting purple blobs in several directions. |  
| Again, just stand back, and you'll avoid them. However, if you are hit |  
| by them, you'll be turned to stone, and lose health quickly. To escape |  
| you'll have to mash the buttons as fast as you can. As for an attack |  
| strategy to use against him, that's up to you. Melee attacks and energy |  
| attacks both work, as long as you stand back when he goes for one of his |  
| energy attacks. When he gets to about a fourth of his health, Vegeta will |  
| show anger at how weak Gohan has gotten since the Cell Games. Then, for |  
| a strange reason, Dabura will ask Babidi to take them back to the ship. |  
'-----'
```

```
-----  
| | | Babidi's Ship | | |  
'-----'
```

Back at the ship, you'll see a cutscene. The Z-Fighters are in confusion about why they are back there. Dabura will then leave for a few seconds, saying that they've found a warrior capable of defeating all of you. And soon Vegeta starts to show anger, and violence. And soon, as the Supreme Kai suggests, Vegeta's body is taken over by Babidi, and he becomes Majin. Goku even comments on how huge Vegeta's power becomes. Vegeta asking if they are afraid, signifies the end of the chapter.

```
-----  
| | | Chapter 5 - Majin Vegeta | [CHP05] | | |  
'-----'
```

```
-----  
| | | World Tournament Stadium | | |  
'-----'
```

When the Z-Fighters and Majin Vegeta arrive at the stadium, everyone is shocked -- including Hercule, who has been announced as the World Champion. Vegeta then shows defiance to Babidi's orders, by not killing all of the Z-Fighters, and he says he only wants to fight Kakarot. Vegeta then blasts a good portion of the Stadium, killing hundreds of people. To keep this from happening again, Goku agrees to fight him. They decide to take it to the nearby Rocky Canyon, however, to prevent innocent people from being killed.

```
-----  
| | | Rocky Canyon | | |  
'-----'
```

At the Rocky Canyon, the Supreme Kai will once again attempt to stop the fight, and Babidi will tell Vegeta to kill him. Again, Vegeta refuses, and Babidi is shocked due to the fact that no one has been able to resist before. Supreme Kai will then forget trying to stop the fight, and will fly off with Gohan. The fight then commences.

```
-----
| MAJIN VEGETA          | For the most part, Vegeta will walk around and |
|-----| shoot small energy blasts at you. So, you should|
| HP: 8500              | be able to get away with punching him. You can |
| STR: 22               | also use a Kamehameha, if you have a high Power |
| POW: 25               | stat, but be careful. He has a devastating Final|
| END: 36               | Flash attack, and if you have to waste time in |
|-----| front of him, powering down from a Super Saiyan,|
| there's a good chance that he'll hit you with it, for some big damage. |
| This battle isn't a full battle though. At three-fourths of his health |
| gone, the screen will fade, and you'll see a cutscene of Gohan and the |
| Supreme Kai entering Babidi's ship. Keep up the work -- Run far away, |
| and power into a Super Saiyan if you end up losing that power -- and |
| deal more damage to Vegeta. Just below half of his health, you'll see |
| another cutscene, this one of Gohan and the Supreme Kai reaching the |
| pod Majin Buu is in. You'll see Dabura and Babidi enter the room, then |
| your fight will continue again. When Vegeta's health nears empty, you |
| will see another cutscene, of Majin Buu starting to hatch. Then, Vegeta |
| will reveal the he deliberately let Babidi control him, in exchange for |
| power. The final stage of the fight will then start. Finish off Vegeta's|
| life bar, and you'll see one more cutscene. |
|-----|
```

This time, Gohan tries to destroy Majin Buu's pod with a Kamehameha, but fails. Majin Buu is then born, in all his fat, pink, glory. Upset at the comments Dabura makes, Buu punches him out. The cutscene then flashes back to Goku and Vegeta. Vegeta then agrees to postpone the fight, because Goku senses Buu, and is too distracted. However, with a chop to the back of the head, he knocks out Goku and eats his senzu bean. He decides to take care of Buu by himself, but first, he wants to destroy Babidi's ship. You'll get control of Vegeta, so walk to the nearby flightpad, and fly off. On the map, you'll be very close to the Southwest Forest (it's marked by a star.) Land there, as that's where Babidi's ship is.

```
-----
| | Southwest Forest | | |
|-----|-----|
```

Save on the Save Circle after landing, then walk through the forest, the same way you did not too long ago, to reach the cliff near Babidi's ship -- Along the way, you'll notice that your Super Saiyan meter is not dropping, due to your Majin powers. Use the flight pad that's there, and you'll see a cut scene. Buu beats down Gohan and the Supreme Kai, and then Dabura spears Buu in the Stomach. Buu turns him into a cupcake and eats him though. Vegeta will then land and destroy the ship, creating a giant crater in the ground.

```
-----
| | Giant Crater | | |
|-----|-----|
```

Babidi is shocked at Vegeta's disobedience, but Vegeta only responds to make a comment about Buu being ugly. Buu gets extremely upset by this, and he goes to attack Vegeta. This is obviously the start of a battle: Not only

with Buu, but with Babidi as well.

```
-----
| MAJIN BUU & BABIDI | This fight isn't too hard, but it does have an |
|-----| original concept: You can't hurt Buu, while |
| HP: 14640/4300 | Babidi is around. So, what you have to do, is |
| STR: 37/0 | just stay out of the range of Buu's attacks as |
| POW: 40/85 | you wait for Babidi to land on the ground. When |
| END: 55/5 | he's hit, he'll become dizzy, and you can give |
|-----| a lot of damage to Buu, before he wakes up. When |
| he does regain consciousness, you can just do it again. Watch out for |
| Buu's attacks though, as he has a few of them. Firstly, his arms can |
| be extended when he punches, so don't think your safe just because he's |
| a few steps away from you. He can also shoot a small energy blasts. And |
| his most dangerous attack, is to fire a pink beam from his head at you. |
| It will turn you into a candy! While in that form, you can't attack |
| so you'll just have to stay clear from him, until you change back -- |
| Because if he gets you, not only will you lose some health, he'll gain |
| some! Stay in the fight, and Buu will go down. |
|-----|
```

After the fight, Piccolo and Krillin will be revived from the stone, just as Goten and Trunks arrive. They fly down to help Vegfeta, who is now on the ground, with Piccolo -- Piccolo helping by chopping Babidi in half. To save Trunks and Gohan, Vegeta knocks them both out, and asks Piccolo to fly them to safety. Vegeta then pays the ultimate sacrifice in an attempt to destroy Buu: He releases all of his energy in one shot, killing himself. Before he does so however, he has one final conversation with Piccolo, that really shows how much Vegeta has changed.

When Piccolo goes to check the Crater, however, not only does he find Babidi still alive, with a new body, he sees Buu form again, from the ashes of his body. Despite Vegeta's sacrifice, Buu is still alive. Piccolo does have the idea that Goten and Trunks may be the key to defeating them. The chapter then ends.

```
-----
| | | Chapter 6 - Dragonballs | [CHP06] | | |
|-----|-----|-----|
```

```
-----
| | | Rocky Canyon | | |
|-----|-----|-----|
```

The chapter starts, at Rocky Canyon, with Goku just waking up from being knocked out by Vegeta. He senses Piccolo at Kami's lookout, so he decides to make that his next stop. Use the flight pad on your right, and then fly over to Kami's Lookout, which is north-west of your current location.

```
-----
| | | Kami's Lookout | | |
|-----|-----|-----|
```

After you land at the Lookout, Piccolo will tell Goku the story of what just happened, while he was unconscious -- Including that Gohan and the Supreme Kai are dead, which he believes to be true. Goku will then explain that if Vegeta hadn't died, he and Vegeta could have done a Fusion to take down Majin Buu. Although, now that Vegeta is dead, they need a new plan. Mr. Popo suggests Goten and Trunks. Goku agrees, but decides that it would be a better plan to collect the seven dragonballs first. You then switch to Goten (And

gain the ability to switch between him and Trunks.) Take the time to save, now. On the world map, fly to the right, into West City.

```
.-----  
|      |      | West City                               |      |      |  
'-----'
```

After landing, head down the street to the right, and enter the Capsule Corp. building complex. Head into the house to the right of the main building, and you'll find Bulma. Talk to her, and she'll be happy to give you the Dragon Radar. Head back to the flightpad you landed on, and fly back to the World Map, after you have it. As you fly around, the Radar will point out the locations of several Dragon Balls, but for the sake of organization, this guide goes through them in order, with the exception of the fourth one, that you have no choice but to get last. The first stop, is the Thieves Den. It's on an island in the lower-right hand corner of the map, and is marked by [6] on the map in this guide.

```
.-----  
|      |      | Thieves Den (1-Star Dragon Ball)       |      |      |  
'-----'
```

Upon landing, you'll find two things: A Save Circle, and a Character Gate. The Character Gate is purple, and has an 80 on it, so you'll need to switch to Trunks, and level him up a bit -- Southwest Forest is probably the best place you have to do this, currently. After you've leveled up enough, return to the Thieves Den, and bust down the gate, and head off the screen to the right from there. There, you'll find several Snipers and Hooligans; Simply fight your way past them, to the next screen.

There, you'll see a bridge on your right. Walk over it, beating up the Goon standing on it, and walk to the next screen. There, you'll find a few more bandits -- Including a few Hessians, armed with rocket launchers. Defeat them, and head to the next screen, to the north. There, you'll find the strong battletank, the Juggernaut. You can just run around it, but if you choose to take it down, just go Super Saiyan and punch it a few times. Four men will fall out, but you can beat them easily. After that's settled, head north again.

There, you'll find a Sniper and a Hooligan. To the right of there, are a few more enemies with rocket launchers, and another fork in the road. The path to the right, leads to a lighthouse; There, you'll be able to do side quests in return for exhibits for the museum. To the north, is the Thieve's Den. That's where you're headed now, so go up there. There are two Criminals near the door, but you'll notice that they aren't hostile. So, rather than fight them, talk to them, after equipping yourself with a [BANDANA] that one of the other thieves you defeated should have dropped (If you don't have one, go defeat some more, so that you can find one.) Assuming you have a Bandana on, you'll be allowed into the town. Use the Save Circle once inside.

Head to the north side of town, and you'll find two houses; The one on the left even has a treasure chest on top, that you can come back as Goku later to reach. For now, head into the building on the right, though. Just walk across the house, and walk up the three flights of stairs, in a row, that you will find. At the top, you'll find a group of bandits, and the leader will allow you to choose a piece of the treasure they have for yourself. Of course, you want the [DRAGON BALL]. So, walk up to the table and grab it.

After you have the ball, however, a monkey will jump off of a nearby shelf, and steal your bandana. The thieves will then realize that you're not a



to show his gratitude. Head back to the left side of the train to exit it. You'll find a world map circle on top of the train, for a quick shortcut out of the desert. Your next stop, is Pilaf's Castle, which is in the southern part of the world. It's marked by a [B] on the map in this guide.

```
.-----.  
|      |      | Pilaf's Castle (3-Star Dragon Ball)      |      |      |  
'-----'
```

After landing, take the time to save, and switch your character to Trunks, via the save circle. Then, smash down the level 80 character gate in front of you. Then, walk across the path on the next screen. On the screen after that, you'll find a couple of Hooligans, but nothing too tough. So, keep going. On the screen after that, you'll finally reach the entrance to the castle grounds -- guarded by a Destroyer. Punch it down, and head onward, crossing over the plank bridge ahead, defeating a few Hoodlums and Hessians. Then, walk into the castle.

Cross the first room of the castle, killing the two Snipers and the Destroyer that you run into, then walk into the courtyard. Before you do anything else here, head into the tower on your left; Trunks will fire a cannon at one of the two Destroyers ahead, killing it! Head into the tower on your right, to take out the second one. With them gone, there won't be anything except for a few basic enemies -- like Hoodlums and Snipers in the area. So, walk across and use the save circle, then proceed into the next room of the castle. From there on in, the castle breaks into many different paths. Here is the quickest, and easiest path.

Punch through crack in the wall, to reveal a door, then pass through it, and kill the Goon in the next room. Continue to the next room from there, and walk down the corridor, defeating the Hoodlums that come out from behind the pillars. Keep going forward into the next room. You'll then come across some ghosts, in a hallway that goes to the right. Punch them out as you had down the hallway, into the next room. There, you'll find another hallway -- this one, with Vampires in it, and a crack on the wall. Kill the Vampires, but forget about the crack on the wall; It leads to a dead end. Walk to the room on the left, to find a pair of Goons, and a save circle. Defeat the Goons, and save your game, then walk into the next room to confront Pilaf. Soon enough, a mech will walk into the room, and a fight will take place.

```
.-----.  
| Pilaf's Guardian      | Despite that Pilaf's Guardian has a 5-digit HP |  
|-----| count, this fight may be easier than what you |  
| HP: 10605             | would have with a normal Destroyer. The reason |  
| STR: 38               | for this, is that he doesn't have a Flamthrower|  
| POW: 0                | attack! He'll only swing his sword. You should |  
| END: 62               | be able to punch him a few times, then back off|  
|-----' when he lifts his arm, efficiently -- Even more|  
| so if you are a Super Saiyan. Only attack him from the front though; If|  
| you attack him from the sides, his sword slashes are faster, and have |  
| no forwarning (you won't be able to see him lift his arm.)           |  
'-----'
```

After you defeat Pilaf's Guardian, Pilaf will run off. Pick up the [DRAGON BALL] that he drops, as well as the [PILAF'S GLOVES] that will fall from the destroyed Pilaf's Guardian. After you have those items, you can backtrack over your steps, to reach the outside of the castle, and ultimately the world map flight pad. You're next stop is the Airship. It is in the middle of the northern-edge of the map, and is shown by an [E] symbol on the map in this guide.





After the fight ends, pick up the [DRAGON BALL] from the ground nearby. A timer will then start ticking down from the three-second mark. You'll have to run back down to the first floor of the ship before it explodes. To do this efficiently, don't confront any enemies unless they are directly blocking your path. Once you reach the flight pad on the first floor of the ship, fly off, and head towards Fukuro Forest, which is near the north-west corner of the main continent, and marked by a [8] in the map of this guide.

-----  
| | Fukuro Forest/Ninja Stronghold (6-Star Dragon Ball) | | |  
-----

After landing in the forest, head north to where you'll find a character gate. The gate is level 80, and is set up to be used by Goten. Use the capsule corp circle in the area to switch to him if necessary, then punch down the door, and head to the next screen. Walk forward, across the next two screens, to see the entrance to the Ninja Stronghold. Head through door in front of you to get inside, then run up the stairs you'll be on. At the top of the stairs, you'll find your first two ninjas. Excuse me, you'll find a ninja, and a shaking treasure chest -- which means a ninja will jump out when you approach it. Punch them both out, then head to the right, through another door in another tree.

In the next room, a Ninja will appear and tell you to leave. Ignore him though, and continue through another door in the tree on your right. There, you'll find three ninjas ready to attack you. Defeat the three of them, then head up some more stairs to the north, to reach another area of the stronghold. There, you'll find two ninjas, as well as two Samurais. The Samurais are stronger, but they still shouldn't take much to dispose of. Once you've done so, you'll notice you are at a branch in the path; There are doors in the trees on both sides of you. Both lead to the same place, but if you take the path to the right, you'll be able to get a Hercule Exhibit, so head that way.

Kill the Ninja in the first room you enter, then head to the right, through another door. There, you'll find three Samurais at the base of a staircase. Defeat them, then ascend the stairs, and take out the Ninjas at the top. There, head to the left, into another tree. Inside, you'll find three Samurais clumped together. Either duke it out with them, or nail them all with a Kamehameha. Doing this will cause a treasure chest to appear in the middle of the room. Open it to receive a [HERCULE EXHIBIT], then head to the left, through yet another door in a tree. After coming out, defeat all of the Samurais in the area, then head north, up another flight of stairs, to another screen. Keep running, to reach another screen after that, where you'll find some more Samurais and Ninjas. Plow through them, to reach the platform above, where you'll find a capsule corp circle. Save your game, then defeat the Samurais and Ninjas on your right, before heading off of the screen to the right.

There, you'll find a grouping of Ninjas -- Including one, who's hiding in a treasure chest. Defeat them, then head through the door on your right. On that screen, you'll find two Ninjas and two Samurais. Fight your way through them, and head through another door on your right. There, you'll find more Samurais, at the top of a flight of stairs. Take them out, then walk down the stairs, to the next screen, where you'll find a few more Samurais and a Ninja. Make your way down the stairs further, then head through the door on your left after reaching the bottom. There, you'll see the head of a stone dragon. Check its mouth, for the [NINJA KEY]. Once you have it, head

back to where the previous save circle was, and save your game again. Once you've saved, open the door to the left of the capsule corp circle, and walk inside. There, you'll see a Dragon ball on the ground. Of course, you can't just take it. The Ninja Boss will appear just in time to have a fight with you.

```
-----
| Ninja Boss          | Soon after the fight begins, you'll come to the |
|-----| conclusion, that this isn't much of a boss. It |
| HP: 5770           | is basically just a normal ninja, with more HP |
| STR: 36            | and a stronger attack. Besides that, they have |
| POW: 23            | very similair patterns, and even the same      |
| END: 25            | scouter description! The only change, is that   |
|-----| ' this one can teleport around a bit, using a  |
| cloud of smoke. Just treat the fight like other  |
| ninja fights though; |
| Watch out for shurikens, then get close and    |
| punch. If he does manage to |
| teleport, just turn around, and do it over     |
| again, until he's beaten. |
|-----|
```

After the fight ends, pick up the [DRAGON BALL] that's on the ground, then leave the room. Backtrack through the Ninja Stronghold, to reach the exit, back in Fukurou Forest. There, head south, back through the character gate, to where there's another capsule corp circle, and a world map flight pad. Save your game again, then take flight. Fly to Kyodai Pyramid, which is near the middle of the main continent, and is marked by [9] on the map in this guide.

```
-----
| | | Kyodai Pyramid (7-Star Dragon Ball) | | |
|-----|-----|-----|
```

Switch to Tunks, just after you land, then walk north and punch down the level 80 character gate. On the next screen, you'll find a large pyramid. Head to the door in the middle of it, and a Scientist will come running to you. He'll show you that he has the Dragon Ball you're looking for, but he won't give it to you unless you save four of his co-workers, who are trapped in the pyramid, and find the pharoah's headdress for him. Once he finishes talking, head inside the pyramid.

Punch out the Mummy that's in the middle of the first room, then head north into the next room. There, you'll encounter a Skeleton. Like the Mummy, he is nothing new. Punch him out, then continue onward. Just be careful where you walk, as the statue can shoot darts out at you if you step on any of the floor tiles that seem to stick out more than the others. Keep moving, until you enter another room, where there are some coffins. In this room there are a number of coffins, and going near them will result in a Skeleton coming out. So, fight your way across the room, and go through the door on the left. There, you'll find three more coffins. Open the first two and kill the Mummies that come out, then open the third one with the A button, to find the first of the four scientists you have to rescue. Once he's safe, return to the previous room, and go through the door on your right.

Inside the next room, you'll see a switch on the ground. Punch it, and a platform will slide to where you are, forming a bridge to another ledge. Walk across it, and punch the switch on that side, and the bridge will slide back to the right. Walk across it again, then toss an energy blast to the switch on your left, to make a second bridge slide by. Walk onto this bridge, then while standing on it, toss another energy blast at the switch on your right, causing the platform you are on to move. Wait for it to stop, then step onto the platform north of you, and toss anther energy blast at the

same switch, causing a third switch to slide over to you. Step onto this bridge, and fire yet another energy blast at the switch, and you'll be brought over to the right. Step onto the platform above, then walk to the north-east corner of it, and shoot the switch on your right, to make another bridge slide by. Step onto it, and shoot the switch on your left, and you will be slide over to a door on your right. When that happens, walk through the door.

Fight your way through the Skeletons in the area, to reach the next room. In the room after that, fight your way around the walls, killing Mummies, until you reach another room. There, it would appear that you have no where to go, but there is actually and invisible floor. And since you can't fall off of it, you'll be able to feel your way around on it, as long as you look out for the several Mummies in the room. When you reach a second visible platform, you'll meet up with the secon scientist you are searching for. From there, head off of the platform to your left, and continue to feel your way around, until you reach a doorway in the lower-left corner of the screen.

Defeat the Mummies in the room, then head north, through the doorway in the middle of the area. In that area, walk north again, into another room. Then, punch out a few more Mummies, and head north one more time. Fight the Mummies in that room, then walk around the wall on your right, and head south, through the doorway that's there. Doing this will bring you to a room with three more Mummies in it. Punch out the Mummies, then head south again. This leads you right to the base of a stairway. Climb the stairs to reach the second floor of the pyramid, then as soon as you reach the top, save your game on the capsule corp circle in front of you. After saving, press the red switch on the ground in front of you, and the locked door on the wall will shake. It will open once you've pressed three more switches.

Next, head off the screen to your right. When you appear in the next room, you'll see lots of holes on the ground, and Ghosts flying around. Try not to get hit, but try more importantly, not to fall, because if you do, you'll be dropped all the way back down to the first floor. To make it through this pseudo-maze, head south then take a right at the first turn. Next, head north, and take the path to your right. Follow it until you reach a wall, and from there you'll see a switch right in front of you. Then from there, head south, and follow along the path until you come to another door. Head through it, and you'll enter another room, with the third scientist standing in front of you. After saving him, head back into the previous room, and backtrack until you reached the first fork in the path. This time, take a left at it, and follow forward, until you reach another door, which you can and should enter.

There, you'll find a group of Skeletons surrounding a switch on the ground. Punch out the Skeletons, then before they can get up, step on the switch. Then, head further to the left, into the next room. After entering, blast the switch you see to the south of you, then follow along the path to the left until you reach a floating platform. Cross it, as well as the one after it, then head to the right where you'll reach the switch again. Hit it, and the platforms will slide over to the right. Cross the one in front of you to reach another platform, then turn around and blast the switch again. After that, head south, and cross another two platforms, then blast the switch south of where you are. Finally, cross the platform directly in front of you, to reach a door; Walk through it.

You'll find various Skeletons and Mummies in that room. Fight your way through them, to reach the door on the southern wall of the room. Walk through it to reach another room full of Skeletons. Punch your way through them, to reach the right side of the room, where the final switch is. Step

on it, and you'll see a cutscene of the door you saw earlier, opening. Once you've seen that, head into the previous room, and fight your way through the Skeletons and Mummies, to reach the door on your right. Go through it, and you'll find yourself back in the room with the previously locked door, and the save point. Save your game, then head through the door in front of you. In the next room, walk forward, and up the stairs, to reach King Totenhotep's tomb. Of course, a battle ensues.

```
-----
| PHAROAH TOTENHOTEP | As you are probably getting used to by now, |
|-----| this boss is just a stronger version of a basic|
| HP: 5770 | everyday enemy. In this case, you'll be facing |
| STR: 36 | a pumped-up Mummy. Watch out though, because |
| POW: 23 | this guy doesn't always throw one bandage at a |
| END: 25 | time; He tosses about 40, and in all different |
|-----' directions! If you are hit by that many, your |
| speed will be slowed to a crawl. If that happens, rapidly hit the D-Pad|
| to break free. Assuming you are not covered head-to-toe with bandages, |
| simply rush forward and beat the crap out of him. He's not that tough. |
|-----'
```

After the fight ends, the door on the northern wall of the room will open. Before you go through it though, pick up the [HEADDRESS OF TOTENHOTEP] from the ground. Then, you're cleared to go through. There, talk to the fourth Scientist, who you'll find there. Don't leave yet though. Open the four chests against the wall in this room, to get the [MYSTIC AEGIS], a [HERCULE EXHIBIT], an [EMERALD AMULET], and [OX-KING'S HAT]. Once you've got all of those, backtrack through the pyramid, and leave the same way you came in. Once outside, the scientists will give you the [DRAGON BALL], before leaving. Head south, to where the flight pad is, and take off. Immediately after doing so, you'll see a cutscene of Goten and Trunks dropping the dragon radar. They'll then fly down to get it, Doing this, will end them both up at Nataday Village.

```
-----
| | | Nataday Village/Volcano (4-Star Dragon Ball) | | |
|-----|-----|-----|-----|-----|-----|-----|-----|
```

After landing in the village, head to the north-west corner of the town, and walk into the house that's there; It's actually the only building that's unlocked anyway. Inside, Goten and Trunks will talk to a village shaman, who has the Dragon Ball, but is rather rude. He agrees to give it up, if the boys defeat a monster who is plaguing the village. After he finishes, head outside, and walk to the wall on the right side of town. There will be a guard blocking a character gate. Talk to him so that he steps aside, then punch the door down as Goten -- It's level 100, so you may have to level up a bit first. Walk north to reach the Northern Wilderness.

As soon as you enter, you'll be surrounded by some Phantoms -- A stronger version of the Ghosts you've faced in the past. You'll come to realize that there are a lot of replica enemies in this area. After punching out, or avoiding the Phantoms, head north to the next screen, where you'll find Elite Majin Fighters, and Elite Majin Soldiers -- You can guess from the name what these are replicas of. Punch your way through them to the north-east side of the area, and head off of the screen to the north again. There you will meet some Grenadiers and a Rapsallion. The Grenadiers are enemies in vein of the Mad Bombers, while the Rapsallion is a basic Criminal. Punch your way through these guys, as you head north once again.

On the next screen, you'll see a Juggernaut tank -- that's not even

something new. So, head forward and attack it until it busts open, and reveals a Hooligan and some Mad Bombers; Once again, these enemies are nothing new, and you can wipe the floor with them. After doing this, proceed further north, where you will see some Vlads (improved Vampires.) Kill them, then proceed still more northern. Once on the next screen, you'll be near a river, which blocks further progress north. So, when that happens, defeat the Rapsallion in front of you, and head east, to another screen. There, you'll find only a Phantom. Take it out, then head east another screen.

There, the river will bend, once again cutting off your path. So, begin following the river, by heading south. Kill the two Majin Fighters you run into, and continue to the next screen, where you'll find the Knight Destroyer. It's a slightly dulled-down clone of Pilaf's Guardian, and it can pack quite a punch if you're not careful. It still shouldn't be able to stand up to many of your punches or energy attacks though, so unleash whatever you have on it, then continue to follow the river's edge further, by heading off of the screen to the right. There, you'll find a few Assassins, or as you may prefer to call them, Gunmen clones. After you've beaten them, head off the screen to the right again. This will bring you to an area with an actual new enemy -- the Ghoul. They are slow, but they can attack with quite a bit of power. There are also Skeletons in the area. Fight your way through these enemies, to reach a bridge that stretches across the river, in the north-east corner of the area. Cross it, and head off of the screen to the north.

There, you'll see several Marauders -- Mercenary look-alikes. Punch your way through them, and exit the screen via the exit north-west of where you enter from. On the next screen, you'll see Grenadiers and a Rapsallion on the cliffs above you. Run to the north, punching these enemies out when you reach them, then head off the screen to the left. This will bring you to a small area, with two Destroyer in it. Take them down and head further to the left. Be careful though, in such a cramped area, their Flamethrower attack may prove to be deadly. Once past both of them, continue to follow the river to the south. There, you'll see two Phantoms. Once again, toss some punches around, and head to the next screen on your left, which holds a couple of Rapsallions. Give them a beating, and head north to the next screen, which happens to be the foot of a volcano. Head north, until you reach the Volcano itself. Once there, head to the right, and save, by using the capsule corp circle that's on the ground.

After that, head to the left side of the area, and walk into the cave, where you'll find Bones -- a stronger Skeleton. Since you can't actually take Bones out easily, just walk around them, to the exit on the right side of the cave. Punch them out if they get too close to you though. Outside, cross the bridge to reach another cave entrance, and head inside there. You'll find three Vlads in total. Fight your way through them to reach the middle of the cave. There, against the southern wall, you'll see a partially hidden door. Go through it to reach a ledge with a chest on the right. Open it to pick up the [CHARGE GLOVES] then head back inside, and walk to the right side of the cave, where there's another exit. Outside of there, walk up the stairs on your right to reach another cave entrance, and proceed inside once again. Head to the left to where there's another exit of the cave once inside, but don't go through it yet. Instead, head to the north-east corner of the cave, and head left to another room.

You'll find several Hooligans there, but nothing big. So continue into the next room from there, where you'll find a Cursed One, a mummy replica. Make your way to the top-right corner of this room, to find a boulder. Punch it out to reveal a doorway. Walk through this doorway, and head to the right,

and you'll come out in another room with a Vlad in it, in front of an exit. Kill the Vlad, then head outside, onto a ledge with a treasure chest on it. Open the chest for a [HERCULE EXHIBIT] then backtrack to the room with the Cursed One in it, and head into another room by walking off of the screen via the passage in the north-west corner of the room. There, punch out a few more Vlads, as you head south, into another room. From there, the exit of the cave will be just in front of you.

Walk outside, and you'll be on a cliff ledge with a switch on it. Step on it, and a bridge will roll out on a ledge below. When this happens, head back into the cave behind you, and backtrack through it, until you are in the first room. Leave through the exit in the lower-left corner of the room, then cross over the bridge you just caused to roll out. There, you'll find another cave to enter. So do so, and inside, be ready to take out a Knight Destroyer immediately. Once it's out of the way, head to the room of the cave on your left, then fight your way through a crowd of Ghouls to reach the room to the north. There, you'll find two Ronins -- a new form of the Samurai -- next to a save point. Punch him out, and save your game. After that, leave the cave by going through the exit to your left, then outside, head to the right to reach the Volcano's summit. After a short cutscene there, you'll enter a fight with another boss, and a wide favorite from the movies, Broly!

```
-----
| BROLY          | Broly is no joke, he's got a lot of HP and is | |
|-----|      | fairly strong if you haven't levelled up alot. |
| HP:  20240    | He can do punch combos, as well as jump into  |
| STR:  32      | the sky, and then drop down on you. If he does |
| POW:  27      | this, just stay moving, and keep away from his |
| END:  70      | shadow, so that he doesn't land on you. Other  |
|-----|      | ' than that, you should just transform into a  |
| Super Saiyan | at the start of the fight, and get in some of your own |
| attacks. Don't use energy attacks though; Broly is capable of blocking |
| each and every one of them. Punches are the way to go. |
|-----|      |
```

Once you've defeated Broly, pick up the [Z-FIGHTER EXHIBIT] that is left behind on the ground, then head back down the Volcano, and back through the Northern Wilderness, to reach Nataday Village again. There, head back into the Shaman's house, in the north-west corner of the town, and after a little "persuading" he'll give up the [DRAGON BALL] -- That would be the last of seven! After receiving it, head back outside, and walk to the southern part of the town, where you'll find a world map flight pad, and a capsule corp circle. Save your game, then fly to the world map, and fly to an airship that Bulma is flying. It should be near Kami's Lookout, and is marked by a star on your in-game map. That will finish off the chapter.

```
-----
| | | | | Chapter 7 - Majin Buu | | | | | [CHP07] | | | | |
|-----|-----|-----|-----|
```

```
-----
| | | | | Capsule Corporation | | | | |
|-----|-----|-----|-----|
```

At the start of the chapter, you'll see a cutscene of the Eternal Dragon being summoned, and the first wish -- that all the people murdered that day would be brought back to life. However, Goku will then show up and stop the Z-Fighters from making a second wish. Goku then uses his Instant Transmission technique to bring everyone back to Kami's Lookout.

-----  
| | | Kami's Lookout | | |  
'-----'

After a little more conversation, Babidi will use telepathy to speak to the people of Earth, including the Z-Fighters. During this broadcast, he destroys an entire city. Goku stops everybody from listening, though, and explains that he is going to teach the boys the art of Fusion. Doing this isn't exactly hard. You'll be shown a sequence of button presses on the screen, and you'll simply have to repeat them. After doing so, the cutscene of Babidi will continue. After it's over, you'll gain control of Goku, and your main objective will become to stop Babidi from reaching Capsule Corp. So, head to the southern part of the Lookout and save your game, then use the world map circle next to the save circle, to take flight. Fly over to where West City is (it's marked by [3] on the map in this guide) and you will see Majin Buu from the map. Fly into him, to land on a roof where he and Babidi both are at the moment. Note, that you should probably level up to level 100 or so before you land here. A good place to level up, would be the Northern Wilderness near Nataday Village.

-----  
| | | West City | | |  
'-----'

Soon after landing, Goku will begin talking with Babidi and Buu. The end result of this conversation, is Goku showing just how strong he's capable of becoming, by transforming into a Super Saiyan 3. You will from then on, be able to transform into a Super Saiyan 3 as Goku, by selecting and using the skill after transforming into a Super Saiyan. Directly afterwards, the fight will ensue.

-----  
MAJIN BUU & BABIDI	This fight works very differently than the last
-----	fight with these guys. The biggest change, is
HP: 45000/4300	that you no longer have to worry about taking
STR: 42/0	out Babidi, before you can hurt Majin Buu. As a
POW: 38/85	Super Saiyan 3, you can go toe-to-toe with him,
END: 65/5	in a melee fight. Back him up against one of the
-----' walls or signs that are on top of the building,	
and punch away at him. Buu has an insane amount of HP, so if you aren't	
at a very high level, it will take a while. However, your Super Saiyan	
3 meter won't drop very fast, so you'll have time to beat him. If you	
did level up, this fight will be over in under ten seconds.	
'-----'

-----  
| | | Kami's Lookout | | |  
'-----'

After the fight, Goku will tell Buu that he'll have a challenge ready for him in two days. Buu will then kill Babidi, as Goku Instant Transmissions himself back to Kami's Lookout. There, you'll watch a cutscene of Goku heading back to Other World with Baba, and after that, you'll play as Trunks, practicing the Fusion Dance again. Once you get it right, you'll transform into Gotenks! Although, for a bit of fun, try messing up on purpose. You'll either become really skinny or really fat. As soon as you get the Fusion done correctly, however, Gotenks will fly to the world map. In his arrogance, he decides to try and face Buu. Once again, you'll be able to find him floating above West City.



-----  
| | | West City | | |  
'-----'

As soon as you enter the city, Gotenks will find Buu threatening two citizens. Sure enough, Gotenks ticks Majin Buu off, and the fight begins.

-----  
MAJIN BUU	Now that Babidi is dead, you wont' be seeing him
-----	flying around anymore. Other than that, the
HP: 45000	fight is virtually the same as when you fought
STR: 42	Majin Buu as Goku, a few moments ago; You don't
POW: 38	have the ability to go Super Saiyan 3 though, so
END: 65	everything's a bit tougher. Stand away from Buu
-----	at the start, and transform into a Super Saiyan,
then punch him into a wall, like you did when you were Goku. You may be	
spending a fair bit of time punching him, since you're so much weaker	
than a Super Saiyan 3, but this strategy does work. Note though, that	
even if you lose, you will continue with the game.	
'-----'

-----  
| | | Kami's Lookout | | |  
'-----'

After you deplete Majin Buu's health until he appears to be near-defeated, Majin Buu will make a comeback, and knock Gotenks out with one hit. Gotenks is barely able to make an escape. When he does so, he'll fly back to Kami's Lookout, where they'll be scolded by Piccolo. After the cutscene ends, the chapter ends as well.

-----  
| | | Chapter 8 - Janemba | [CHP08] | | |  
'-----'

-----  
| | | Buu's House | | |  
'-----'

At the start of the chapter, you will not be playing as any of the Z-Fighters. You'll be playing as Hercule! He's like Videl; Which means he isn't very strong. You won't be doing any fighting though, so don't worry. Just walk forward until you reach a house shaped like a caterpillar. You'll then see a short cutscene between Hercule and Majin Buu. By the time you actually gain control to play again, you'll be playing as Goku on Snakeway.

-----  
| | | Snakeway | | |  
'-----'

Follow along Snakeway to the east, off of the screen, to reach the ending near the "head" of Snakeway. There, head up the stairs to the north of you to reach King Yemma, who is trapped in some kind of jelly bean-shaped prism. He'll tell you about an enemy named Janemba, who has taken over HFIL, and must be defeated. King Yemma also tells Goku that he sent Vegeta to HFIL earlier, and that Vegeta may be able to help him. After that, an Instant Transmission circle will appear in front of you. Step on it, and press A, and you'll be able to select several locations to land: HFIL, King Yemma's Office, the Grand Kai's Planet, and Heaven are the only places

that are open at the moment though. For now, choose H.F.I.L. Although, if you'd like, you can have a quick look at heaven, to see Dabura...

```
.-----.  
|      |      | HFIL      |      |      |  
'-----'
```

The first thing to do after landing, should be saving your game by using the capsule corp logo on your left. Once that's been accomplished, head off of the screen to the north, to reach a screen full of the Living Dead -- Powered up Ghouls. Punch your way through them, but try to move quickly, or you may be attacked by Janemba hands, which will appear through portals in the air, and try to punch you. It's best to just avoid them. So, make your way to the north-east corner of the area, where you'll see a switch just beyond a ledge you can't get by. Use Goku's Instant Transmission to reach it, then head off of the screen to the right.

There, you'll see several Poltergeist. Phantoms, Ghosts, Poltergeists... They all fight the same. So, punch them out, then walk to the next screen. You'll still be coming across Janemba Hands, but as previously mentioned, just ignore them. On the next screen, you'll see a Nosferatu, a stronger version of the Vampires and Vlads you've fought, but he's beyond a ledge, and can't get to you. So, ignore him, and head to the next screen on your right, where you'll see several more enemies blocked off by a ledge between the two of you: Liches. Liches are stronger version of the Bones you fought back at the Volcano.

Follow along the path, until you reach a wall of spikes. There, head north until you reach a break in the ledge, to your left. When you reach it, head to the left and open the chest in front of a tree, to obtain a [TALISMAN OF LIGHT]. Once you have it, run past the Liches, since you can't punch them out anyway, to the screen on your left. There, take a moment to punch out the Nosferatu you saw earlier, then head off of the screen by walking along the path in the lower-left corner of the area. There, you will be next to the Poltergeist you saw earlier. Punch out a few if you wish, then head to the left just slightly, and double back up, heading north once more.

Continue to head north, until you reach another screen -- A screen with an Annihilator, another member of the Destroyer family, on it. Get in its face, and show it who's boss, then exit the screen to the north-east. You will again be faced with a Living Dead to kill. Make him job, then head to the north, to another screen. Kill the Nosferatu that's there, then head south, following the one path that's available, to the next screen. Take out the pair of Living Deads that are there to greet you, then head to the right side of the area, to where there's a second wall of spikes. Head north from there, killing any other Living Dead you run into, to the next screen.

Immediately head off-screen to the right. You'll then find yourself in an area filled with Liches, and a few Living Deads. Just avoid the Liches, as you head to the right of the area, around the trees. If you head to the bottom-right corner of the area, you'll reach a save circle that you can use. Head north of there, and you'll find a treasure chest which contains the [SPIRIT GETA]. After obtaining that, and possibly equipping it, head south and exit the screen through the break in the trees. You'll enter into a maze-like area.

Start by heading downward until you reach some spikes. There, look to your left and you'll see a chest. Use your Instant Transmission technique to reach the chest, and obtain the [DOOM AMULET]. Then, get real close to the

spikes, and you'll see a switch on a ledge past them. Use Instant Transmission to hit the switch, lowering the spikes, and raising them in other places. Walk forward a few paces, past the lowered spikes, then hit the switch again. After that, walk along the linear path, avoiding the annoying Janemba Hands, until you reach another set of spikes. Again, use Instant Transmission to press the switch, and make your way past them. Follow along the path further, doing this again for the next two set of spike blockades. There, head north to reach a spiked wall. Follow along the walls, being careful not to touch them, until you reach the upper-right corner of the area. There, head off-screen to the right.

There's a save circle in front of where you enter; use it. Then, talk to the soul on your right, who will take form as Vegeta. Goku will convince Vegeta to help him, just as the screen fades away, back to where Hercule and Majin Buu are. After that scene ends, you'll see a cutscene of what's going on back at the Lookout. After that, you'll see another scene with Hercule and Buu. Finally you'll return to HFIL where you'll have control of Goku once more. Kill the Living Dead that will have surrounded you, then use the Capsule Corp circle to switch to Vegeta; you'll need him soon.

Head back to the previous screen, on your left. Walk along the wall with spikes on it to your left, to reach a large boulder. Punch it, to destroy it and clear the path, then head off of the screen to the north. Backtrack through HFIL, fighting off the hordes of the undead, to reach the spot where you landed, earlier. Head north to the next screen from there, to an area where you have not been yet. There you'll find a level 100 character gate for Vegeta. This is why you should have been using him: to level him up. If he's strong enough, punch through the door. If not, head back and kill some more enemies to get him to level 100.

There, you'll find Pikkon lying on the ground, unconscious. When he comes through, he'll tell you that Janemba beat him down. When he's done talking, save your game on the nearby capsule corp circle, then head north, to the next screen. As soon as you step onto the screen, you'll see the fat tub of crap -- I mean Janemba. The fight will then begin.

```
-----
| JANEMBA           | The first form of this guy isn't too tough. You |
|-----| will notice, he has an attack and power of zero. |
| HP: 8880          | He just sits there! However, Janemba hands will |
| STR: 0            | be appearing all around the battle field, trying |
| POW: 0            | to strike you -- and they go considerably faster |
| END: 70           | then they did in the rest of the HFIL. You won't |
|-----| even have time to transform into a Super Saiyan. |
| Rather than try and be slick and dodge the hands, you should just get up |
| close to Janemba and wail on him, as fast as you can. While he does have |
| one more trick up his sleeve -- jumping up and landing, creating four |
| miniature versions of himself -- he is not a big threat. Yes they can do |
| damage, but one punch or two will take the clones down. Then, it's just |
| back to punching him, until his health bar diminishes. Like all good |
| bosses though, he has to transform! So get ready for round two. |
|-----|
```

```
-----
| SUPER JANEMBA     | Janembas second form has slimmed down quite a |
|-----| bit; he can even move now! At the start of the |
| HP: 25840         | fight he'll KO whichever character you were |
| STR: 47           | using, be it Goku or Vegeta. So you'll have to |
| POW: 70           | make due using the other one. Yes Janemba can |
| END: 55           | punch you now. Yes, he can walk around the area. |
|-----|
```

-----' Hell, he can even teleport behind you, if you  
| try and get away from him, and he can toss energy waves. There are no  
| more annoying Janemba hands popping up though! So, even though you still  
| don't want to transform into a Super Saiyan -- because he'd catch you  
| and hit you during the transformation -- you can take your time with the  
| fight. Punch him when you get an opening, and try to back him up some  
| steps. He'll most likely transform to get out of your combo. If that  
| happens, try and move as fast as possible, before he nails you from  
| behind. Heal if you have to; He's fast, and he may land some of his  
| attacks on you. If he gets away from you, back off, then go in and try  
| to combo him again. As his HP gets lower, he'll become desperate, and  
| start teleporting around randomly. Punch him if he appears near you, but  
| other than that, you'll have to wait him out. Once he solidifies, go on  
| the attack again. He's still not down and out though; In fact, his HP  
| will refill to 25840, again, once you empty it. Goku and Vegeta will  
| then start a fusion though. So, follow the button presses on screen, and  
| you will find yourself controlling Gogeta! After that, Janemba is just a  
| joke. You're faster and stronger than him. Either punch him out, or hit  
| him with the awesomely-cool Dragon Fist Explosion, for some damage. Both  
| options will send Janemba to the ground quicky: For good this time.  
-----'

After the fight, Goku and vegeta will separate. Vegeta will then take the form of a soul again, and fly off. You will take control of Goku. Head south two screens to reach where you entered HFIL. There, step onto the capsule corp circle, and save your game. Then, step onto the warp pad. You can stop at Heaven, and talk to Dabura there. He'll give you a valuable item, the [CRYSTAL O-YOROI], if you talk to him. Yemma's Office is your actual destination, however. So after talking to Dabura, head over to it.

-----  
| | | Snakeway | | |  
-----'

Walk into King Yemma's office, and talk to the King. Upon Goku asking, King Yemma will tell Goku that his son, Gohan has not died yet, and that he is still alive. Afterwards, you'll see another cutscene involving Majin Buu and Hercule. Hercule will be shot by one of the gunners from earlier. Buu will revive him, but his anger will get the best of him. Unable to control himself, Buu's evil half separates from his good half. In battle, the evil half wins, and consumes the good half. The reunification leads to the birth of a newer, stronger -- and completely evil being: Super Buu!

-----  
| | | Chapter 9 - Super Buu [CHP09] | | |  
-----'

-----  
| | | Snakeway | | |  
-----'

The chapter starts back in King Yemma's office, with Goku. Walk outside, and Goku will wonder aloud where Gohan is. Then it will hit him. Gohan is with the Supreme Kai. Upon realizing this, a new icon, the Supreme Kai's planet, will appear on the warp circle map. You'll be able to warp to and from there using the warp circles from now on. However for now, Goku will just use instant transmission to get there.

-----'



bring Goten and Trunks to the Hyperbolic time chamber. There, an hour seems like many days. Once inside, talk to Goten, and he'll ask to start sparring. This will be the beginning of your training.

```
-----
| GOTEN          | Remember earlier in the game, when you faced off |
|-----| against Goten in the tournament? Remeber how it |
| HP: 4500       | was a short and easy fight? Well it's the same |
| STR: 28        | thing all over again here. Goten's stats have |
| POW: 36        | been buffed up slightly, but that's because you |
| END: 35        | do as well. He still has the same basic punches |
|-----| and energy blasts that he had then. The only |
| difference, is that now he has no intent on going Super Saiyan. Smack |
| him around a bit, and he'll decide that he'd rather eat than fight. |
|-----|
```

You'll take control of Trunks, in the kitchen area. It's full of pots that you can smash by punching. Doing this will net you a whole bunch of coins that you can, of course, use to purchase items later. Some of the pots contain items themselves, such as milk and rice balls. After you've emptied the contents, head to the room on the left: the dining room. Use the capsule corp circle that's there to save, then head south, back into the sparring area of the time chamber. You can face Goten again if you like. You can do this to gain some levels. When you really want to move on, though, talk to Goten and when he asks you to spar, select "No." Trunks will come up with the idea to try Fusion.

You'll then see a cutscene of Piccolo and the others. Buu has decided that 30 minutes has been long enough a wait. Piccolo uses telekenisis to contact Goten and Trunks, and tell them that Buu his on his way. Goten and Trunks will then be told to fuse. So, input the button sequence that is shown on screen, to fuse into Gotenks. Just as soon as they finish, Buu and Piccolo will arrive in the Time Chamber. The fight will immediately begin.

```
-----
| SUPER BUU      | This fight is not that tough -- it's simply in |
|-----| place to further the story. Run off to a corner |
| HP: 35330      | of the room, and transform into a Super Saiyan |
| STR: 50        | before Buu can interrupt the transformation with |
| POW: 65        | an energy blast. Then, get close to him, and |
| END: 55        | give him some punches. It won't take much to |
|-----| empty his health bar, but he will immediately |
| stand up again, right afterwards. Gotenks will then say that he is out |
| of ideas (and smile, since he is just trying to build drama.) |
|-----|
```

Piccolo does not catch on. Fearing the worst, he destroys the entrance to the Hyperbolic Time Chamber, trapping Gotenks, Buu, and himself inside. Too late does Gotenks reveal that he had a hidden technique that could have won the fight for him. On top of that, the plan is ultimately a failure. Buu tears a rip in the dimension, and steps back onto the Lookout. Piccolo and Gotenks try to do the same by screaming, and fail miserably; until Gotenks reveals his ultimate technique, that is. Transforming into a Super Saiyan 3, Gotenks easily tears his own portal open, and follows Buu.

```
-----
| | | Kami's Lookout | | | |
|-----|
```

Back on the lookout, Piccolo and Gotenks find nobody aside from Majin Buu.



-----  
| | | Barren Wasteland | | |  
'-----'

Buu will begin to flash, and will ultimately self-destruct. Gohan is sure that he's still alive, but he also senses Dende; And finding him is the main priority. So, take a moment to save, by using the capsule corp circle that's behind you. After you're done, head off of the screen to the north. There, you'll run into Hercule and Bee: the dog. Walk forward and talk to him. When he finishes talking, head north to the next screen.

There you'll find a Death Machine -- the latest, and toughest member of the Destroyer family. As usual attack it from an angle so that the flame attacks can't hurt you. When it's gone, move further along the path. You'll run into a second one. Kill that one as well, then head off the screen to the right. You'll be greeted by a Hyper Cyborg (a tougher version of the Cyborgs you saw way back on the giant airship) and another Death Machine. Take them both out, as well as a third Hyper Cyborg. You'll reach a character gate. You'll need Gohan at level 140 to get through it, and that may take a while. Don some weighted clothing to make things easier, then walk back and forth between the screens in the area, killing Cyborgs and Death Machines until you reach level 140.

When your level is high enough, punch the door down, and head onward, to the next screen. There, head around the large rock, to the right, and you'll find the others as well as Dende. You'll also find Majin Buu again. He wants to fight Gotenks, though. So, you'll be given control of the boys, and be told to do a fusion. Perform the on-screen button string correctly, and Goten and Trunks will transform into Gotenks. No fight will happen though. Instead, Buu tricks Gotenks, and absorbs him becoming even stronger than he was before. He even gets Piccolo, making him considerably smarter. You will fight Super Buu again, when he finishes talking. He's much stronger than he was before though.

-----  
SUPER BUU 2	This version of Buu is completely different from
-----	the other fights. The amount of HP he has is
HP: 105300	ridiculous, and he has great strength and great
STR: 55	defense. Not only that, thanks to the absorbtion
POW: 75	of Gotenks, he has a new trick: The ability to
END: 65	create ghost clones, which will attack you. If
-----' he does create these ghosts, shoot energy blasts	
at them; You don't want to try punching them, as they will damage you.	
Other than that, the same old punching technique applies. Even though	
his health bar will barely be affected, the damage does add up. Even	
though you'll only have the meter emptied about one-fifth of the way,	
when he reaches 0 the fight will end. He will KO you, yes. But the fight	
will end none-the-less.	
'-----'

A cutscene with Goku and the Kais will occur after the fight. The old Kai gives up his life so that Goku may return to earth. He also gives Goku the Potara earrings to allow him to fuse with someone permanently. Goku chooses Gohan, but when Super Buu absorbs him and becomes even more powerful, that plan falls through. That leaves Vegeta. Vegeta, however, wants nothing to do with that, and flies off to take on Buu by himself.

You have to go and stop Vegeta, but there's a character gate ahead. You'll have to train Goku to level 140, just like you did to Gohan. The Metal Hulks, and Death Machines in the area should make that rather easy to do. Just







on the scouter, but he is an enemy.

```
-----
| Z-Fighter Clones      | Punch the Gotenks clone a few times to kill him |
|-----| then walk forward to the next screen. You'll see|
| HP:  ??/60000/75000  | the real Goten and Trunks trapped inside pods  |
| STR:  ??/58/63       | attached to Buu's body. For now, though, just  |
| POW:  ??/60/70       | head to the next screen. There, you'll fight a  |
| END:  ??/57/57       | Gohan clone. Again, nothing tough for you. Knock|
|-----| some sense into him, then proceed to the next  |
| room, where Gohan's body is trapped in a pod. In the next room, you'll  |
| face a Piccolo clone. Take him down just like the others.  |
|-----|
```

After you've finished off the Piccolo clone, walk to the next room, where you'll find his body, also trapped in a pod. Again, there's nothing you can do yet. So proceed to the next room. There, you'll find a capsule corp circle with which you can save your game. Save, then head through the door just north of where you are. This leads to the Brain. Yes, I too find it a little odd that passing through the Intestines leads to the brain.

```
-----
|      |      | Buu's Brain          |      |      |
|-----|-----|-----|-----|
```

Goku will catch up with Vegeta inside the brain. He will again suggest doing a Fusion Dance. Vegeta will refuse, but then point out an amazing find. The original form of Majin Buu is trapped in a pod just like the Z-Fighters! Before they can solve the puzzle, Super Buu creates a clone of his original Super Buu form, with which he can fight Vegeta. Goku will fly off just in time to be of no help to you, whatsoever.

```
-----
| Super Buu Clone      | Buu is pretty fast now, and he can do a few new |
|-----| attacks, such as stretching his arm out to punch|
| HP:  100000          | you. For the most part though, he's not much of |
| STR:  63             | an improvement over previous fights. He does  |
| POW:  90             | have quite a bit of HP, though. Run off to the |
| END:  70             | side and transform into a Super Saiyan, then  |
|-----| either use melee attacks, or punches, depending |
| on which you've been leveling up. That, along with the fact that his  |
| stretch punch replaced his candy beam attack, make this fight very easy. |
|-----|
```

After the fight, Buu shouts that he "won't be me anymore". When the clone's body explodes, walk through the door just north of where you are to escape from Buu's body through a steam receptical on his head. Goku and Vegeta take the bodies of the boys, Gohan, and Piccolo to safety. In a fit of rage, Buu then transforms into his strongest form of all: Kid Buu. Despite Hercule's claim that even he could beat Buu up now, this form is powerful.

```
-----
| |__| |      | Chapter 11 - Kid Buu          [CHP11] |      | |__| |
|-----|-----|-----|-----|
```

```
-----
|      |      | Supreme Kai's Planet          |      |      |
|-----|-----|-----|-----|
```

The Supreme Kai and the old Kai talk about Buu, in a cutscene. The Supreme Kai tells about how Buu once absorbed one of the Kais. And though this made him better at fighting, the kindness actually suppressed some of his evil instincts. With that gone, the new Kid Buu is completely evil, and far more dangerous than ever before. Goku is told to go and train more, and return to the Barren wasteland when he's ready to face Buu. Truthfully, you can take him now. This is just a chance to finish up sidequests you may have left undone. When you're ready, land at the Barren Wasteland to fight.

```
.-----  
|      |      | Barren Wasteland      |      |      |  
'-----'
```

After you land, Buu will begin to unleash a powerful energy field -- he ignores Goku and Vegeta completely. The earth actually shatters. Goku is able to save Dende and Hercule, but isn't able to save the others in time. He uses Instant Transmission to bring all of the survivors to the Planet of the Kais.

```
.-----  
|      |      | Planet of the Kais      |      |      |  
'-----'
```

After a bit of humorous comments from Hercule, the Supreme Kai looks into the crystal ball, to see Earth. They see that Buu is still very much alive. He is warping from planet to planet, blowing himself up and reforming, in an attempt to find Goku and Vegeta. Goku and Vegeta raise their power levels to allow Buu to sense them. And it's not long at all before he arrives at the Planet of the Kais. After a game of Rock Paper Scissors, it is decided that Goku will be the first to challenge Buu.

```
.-----  
| Kid Buu      |      | Goku starts the fight as a Super Saiyan 3, which  
|-----|      | makes things much easier. This is not a fight  
| HP: 125000   |      | where you can just pin Buu to the wall though.  
| STR: 66      |      | try and punch him a few times, and he'll warp  
| POW: 110     |      | behind you, similar to Janemba. When he does  
| END: 100     |      | that, try to move away before he can hit you.  
|-----|      | You're Super Saiyan 3 won't run out, which makes  
| things easier. You have to watch out for some of his surprises though,  
| like the Kamehameha. This can be particularly dangerous when he warps  
| and then uses the beam. You'll have to take off about a fifth of his  
| health bar to progress further. When you do that, Buu will knock out  
| Goku, and Vegeta will step up to the fight. Unlike Goku, Vegeta does not  
| start as a Super Saiyan; and you won't even have your meter filled to be  
| able to transform into one. Despite that, the fight works in the exact  
| same way. So, chisel away at his HP some more, until his health bar  
| reaches the halfway mark (the numbers don't matter, since you'll notice  
| that it has went back up to 125000 again.) At that time, Vegeta will be  
| defeated as well. Goku will then step back in -- without Super Saiyan  
| ability in effect. Buu's health meter will have filled yet again, as  
| well. Fight off Buu until it does fill, then become a Super Saiyan 3.  
| This time it will gradually wear off, but still, it'll let you fight Buu  
| more easily. And it won't come a moment too soon, since Buu will now be  
| splitting into several bodies, both of which will be attacking you. Take  
| off a fifth of his health (again). Goku will say he needs energy, so  
| Vegeta steps in again. This is not a normal fight anymore though. Vegeta  
| only has to last 60 seconds -- a timer will appear on screen to count it  
| down. Simply run away from Buu for one minute. It's easy.  
|-----'
```

After Vegeta lasts a minute, Goku will say that he needs more time. Just then, Vegeta gets punched down, and Buu loads an energy blast to finish him off. Hercule is actually the one to make the save though. Yes, Buu punches him away like an insect, but he also distracts Buu, saving Vegeta. After that, the fat Majin Buu finally manages to separate from Kid Buu, he then stalls for more time by fighting Kid Buu.

After another cutscene between Goku, and Vegeta, the Namekian dragon balls will be used to restore the earth, and all of the people on it. Goku will then begin forming a Spirit Bomb, using their energy. As Vegeta, you'll have to avoid Buu for another 60 seconds while he does this. The people are reluctant to help, until Hercule tells them to. He does indeed steal the credit for fighting once again, but it does get the people to help. With all of this, though, Buu is still able to push the spirit bomb away. That's when the second wish is made: to return Goku to full strength. You'll then enter a mini-game where you have to press A and the control pad as fast as you can, to push the spirit bomb into Buu. So mash the buttons!

Once the bomb connects, Buu is defeated for good. You'll be told to fly to Capsule Corp for the celebration. You'll also be shown that a warp pad has appeared at Kami's lookout, and be told that enemies around the world have become stronger. There are a few more sidequests available in the game, but to finish, you really have to go to Capsule corp. And remember to save on the way, since you can't do that after viewing the ending, and you don't want to have to defeat Buu all over again!

```

.'_____'-----.'_____'
| |__| |      | Chapter 12 - A New Beginning          [CHP12] |      | |__| |
'_____'-----'_____'

```

Walk into the Capsule Corp building, and through the lobby, into the atrium of the building. You'll be asked if you won't to continue into the final sequence of the game. If you've already saved, select "Yes". Then, watch the cutscene for the ending. The game is over. Congratulations.

```

      -"-----"
     / \ / \ / \
    /   /   \   \
   /___/___\___\
  /   /   \   \
 /___/___\___\
 \   \   /   /
  \___\___/___/
     \ / \ / \ /
      -"-----"

=====
| 05. Technique List          [MOVES] |
=====

```

-----  
Banshee Blast

=====

User(s): Vegito

Description: Hold the B button to emit 5 thin, powerful beams of energy: One from each finger.

-----  
Big Bang

=====

User(s): Vegeta

Description: Press the B Button and release to emit a large ball of energy that explodes on contact. Hold the B Button longer to make the attack stronger.

---

---

Big Bang Kamehameha

=====

User(s): Gogeta

Description: Hold the B Button to create a large ball of energy followed by a long beam.

---

---

Burning Attack

=====

User(s): Trunks

Description: Press the B Button to shoot a spiked ball of chrono-energy which stuns enemies on contact. Hold the B Button longer to increase stun time.

---

---

Dragon Fist Explosion

=====

User(s): Gogeta

Description: Hold the B Button to create a giant dragon of pure energy. Use the +Control Pad to move the dragon's head. Release the B Button to make the dragon bite.

---

---

Electric Kamehameha

=====

User(s): Gohan

Description: Hold the B Button to emit a long beam of energy. Enemies hit by this beam can become electrically charged.

---

---

Energy Blast

=====

User(s): Goku, Gohan, Goten, Trunks, Vegeta, Gogeta, Gotenks, Vegito

Description: Press the B Button to shoot out a concentrated missile of internal energy. Press the B Button multiple times to shoot out many blasts.

---

---

Energy Punch

=====

User(s): Goten

Description: Press the B Button to throw a mighty punch, enhanced with energy.

---

---

Energy Sword

=====

User(s): Vegito

Description: Press the B Button to create a glowing sword of energy. When

fully charged, continue holding the B button to spin around, and press the control pad to move.

---

#### Final Flash

---

User(s): Vegeta

Description: Hold the B Button to emit a long beam of energy which travels across land instantly.

---

#### Flame Kamehameha

---

User(s): Trunks

Description: Hold the B Button to emit a chain of energy flames. While holding the B Button, press the +Control Pad to move the flames like a whip.

---

#### Instant Transmission

---

User(s): Goku

Description: Hold the B Button to bring up the cursor. Use the + Control Pad to select an item, enemy, or switch. Release the B Button to teleport there and back.

---

#### Kamehameha

---

User(s): Goku

Description: Hold the B Button to emit a long beam of energy.

---

#### Kamekameha

---

User(s): Goten

Description: Mispronounced by Goten. Hold the B Button to emit a long beam of energy.

---

#### Masenkoha

---

User(s): Gohan

Description: Hold the B Button to make a cursor appear in front of the player. Upon releasing the B Button, a large ball of energy will be thrown at the cursor's location.

---

#### Super Kamikaze Ghost Attack

---

User(s): Gotenks

Description: Hold the B Button to create small fghost replicas. Let go of the B Button to release the ghosts, which attack the closest enemy and explode on contact.

-----  
-----  
Super Saiyan

=====

User(s): Goku, Gohan, Goten, Trunks, Vegeta, Vegito

Description: Press the B Button to transform into a Super Saiyan.

-----

-----  
-----  
Super Saiyan 3

=====

User(s): Goku

Description: Press the B Button, while Super Saiyan, to transform into a Super Saiyan 3.

-----

-----  
-----  
Ultra Volleyball Attack

=====

User(s): Gotenks

Description: Press the B Button to emit a beam that turns enemies into giant volleyballs.

-----

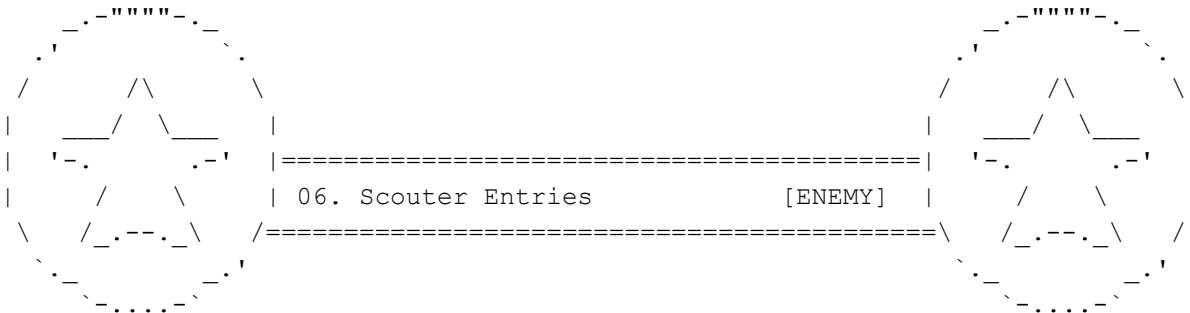

-----  
AIRSHIP WARLORD

| HP: 7680 Watch out for this Cyborg's killer claw! |

| STR: 34 |

| POW: 0 |

END: 47

Locations: Airship

-----  
ALIEN ANNOUNCER

| HP: ?? This fungus alien is well known as the |  
| STR: ?? announcer of the Other World Tournament. |

| POW: ?? |

END: ??

Locations: Other World Stadium



ANNIHILATOR

HP: 4768 A robot with thick geromantium armor that  
STR: 37 makes it invulnerable to most conventional  
POW: 70 attacks.  
END: 55

Locations: HFIL

ANNOUNCER

HP: ?? This Announcer has been announcing Martial  
STR: ?? Arts Tournamanets since back when Goku was a  
POW: ?? kid!  
END: ??

Locations: Papaya Island

ANDROID #18

HP: ?? Once Dr. Gero's evil Android, she has now  
STR: ?? changed her ways and fights for the good guys.  
POW: ?? Is married to Krillin.  
END: ??

Locations: Roshi's Island  
Papaya Island

ASSASSIN

HP: 1645 A known criminal, wanted on several counts of  
STR: 25 mischief and multiple counts of high jinks.  
POW: 54  
END: 50

Locations: Northern Wilderness

BABIDI

HP: 4300 An evil wizard. Babidi is the son of Bibidi. He  
STR: 0 controls people by exploiting the evil in their  
POW: 85 hearts.  
END: 5

Locations: Giant Crater  
West City

BIO MECH

HP: 2175 Watch out for this Cyborg's killer claw!

STR: 29  
POW: 0  
END: 47

Locations: Airship

#### BLISTER

HP: 18530 This blister creates Enzymes.  
STR: 0  
POW: 0  
END: 75

Locations: Buu's Stomach

#### BLOOD CELL

HP: 3085 The Blood Cells in Buu's immune system don't  
STR: 55 like intruders.  
POW: 0  
END: 35

Locations: Buu's Stomach

#### BOMBER

HP: 125 A bomber armed with dangerous explosives.  
STR: 9 Approach with extreme caution.  
POW: 14  
END: 18

Locations: East Forest  
Hercule City  
Musaka Circus

#### BONES

HP: 1015 The bones of the dead are animated by an  
STR: 18 unseen force.  
POW: 0  
END: 45

Locations: Volcano

#### BROLY

HP: 20240 Broly is the Legendary Super Saiyan,  
STR: 32 prophecised in ancient Saiyan folklore. Once  
POW: 27 defeated by Gokun he has returned, insane  
END: 70 with rage.

-----  
Locations: Volcano Summit

-----  
BULMA

| HP: ?? Bulma Brief is the daughter of the founder |  
| STR: ?? and president of the Capsule Corporation, |  
| POW: ?? Dr. Brief. Bulma has many invention patents |  
| END: ?? in her name, most noticeably the Dragon Radar. |  
| Bulma is often involved in Goku's adventures |  
and is married to Vegeta.

| Locations: Capsule Corp |  
Papaya Island

-----  
CHI-CHI

| HP: ?? Chi-Chi is Goku's wife and Gohan and Goten's |  
| STR: ?? mother. She is the daughter of the Ox-King. |  
| POW: ?? |  
END: ??

| Locations: Gohan's House |  
Papaya Island

-----  
CRIMINAL

| HP: 115 A known criminal, wanted on several counts of |  
| STR: 10 chicanery and multiple counts of shenanigans. |  
| POW: 0 |  
END: 18

| Locations: East Forest |  
| Hercule City |  
| Musaka Circus |  
| Stolen Airship |  
Thieves' Den

-----  
CURSED ONE

| HP: 2062 From the ancient sands of time these mummies |  
| STR: 0 awaken to curse the living. |  
| POW: 37 |  
END: 56

Locations: Volcano

-----  
CYBORG

HP: 875 Half-man... Half-machine... All deadly.

STR: 22  
POW: 26  
END: 41

Locations: Airship

#### DABURA

HP: 10000 Dabura is the ruler of the Underworld. He is  
STR: 22 a henchman of Babidi.  
POW: 5  
END: 51

Locations: Demon World (Babidi's Ship)

#### DABURA (NPC)

HP: ?? Dabura is the ruler of the Underworld. He is  
STR: ?? a henchman of Babidi.  
POW: ??  
END: ??

Locations: Heaven

#### DEATH MACHINE

HP: 12248 A robot with thick geromantium armor that  
STR: 50 makes it invulnerable to most conventional  
POW: 90 attacks.  
END: 70

Locations: Barren Wasteland

#### DENDE

HP: ?? Dende is the Guardian of Earth and an alien  
STR: ?? from the planet Namek.  
POW: ??  
END: ??

Locations: Kami's Lookout

#### DESTROYER

HP: 3762 A robot with thick geromantium armor that  
STR: 25 makes it invulnerable to most conventional  
POW: 50 attacks.  
END: 40

| Locations: Southwest Forest |  
| Diablo Desert |  
| Pilaf's Castle |  
| Airship |  
Northern Wilderness

DR. BRIEF

| HP: ?? Dr. Brief is the president of the Capsule |  
| STR: ?? Corporation, and Bulma's father. |  
| POW: ?? |  
END: ??

Locations: Capsule Corp

ELITE MAJIN FIGHTER

| HP: 1250 A martial artist who has been converted over |  
| STR: 33 over to Babidi's side. |  
| POW: 0 |  
END: 51

Locations: Northern Wilderness

ELITE MAJIN SOLDIER

| HP: 1380 One of Babidi's Majin Henchmen from an unknown |  
| STR: 0 unknown alien species. |  
| POW: 45 |  
END: 54

Locations: Northern Wilderness

Emperor Pilaf

| HP: ?? The bumbling Pilaf has tried to take over the |  
| STR: ?? world many times, but is usually foiled by |  
| POW: ?? Goku. |  
END: ??

Locations: Pilaf's Castle

ENZYME

| HP: 5420 Enzymes assist Buu in digestion. |  
| STR: 25 |  
| POW: 0 |  
END: 25

| Locations: Buu's Stomach |

ERASA

HP: ?? Erasa attends Orange Star High School with  
STR: ?? Gohan.  
POW: ??  
END: ??

Locations: Orange Star High Shool

FIGHTER

HP: 175 This is a martial artist from the Other world.  
STR: 10  
POW: 0  
END: 20

Locations: Grand Kai's Planet

GHOST

HP: 750 These spirits come from the Other World to  
STR: 15 haunt the living.  
POW: 0  
END: 32

Locations: Pilaf's Castle  
Kyodai Pyramid

GHOUL

HP: 1495 When there is no more room in H.F.I.L the dead  
STR: 36 will walk the earth.  
POW: 0  
END: 36

Locations: Northern Wilderness  
Volcano

GRENADIER

HP: 1475 A bomber armed with dangerous explosibes.  
STR: 23 Approach with extreme caution.  
POW: 55  
END: 56

Locations: Northern Wilderness

GOHAN

HP: -- Gohan is the son of Goku and Chi-Chi. He is  
STR: -- half human and half Saiyan. Gohan defeated  
POW: -- Cell in the Cell Games.  
END: --

Locations: --

GOHAN (CLONE)

HP: 60000 Gohan is the son of Goku and Chi-Chi. He is  
STR: 58 half human and half Saiyan. Gohan defeated  
POW: 60 Cell in the Cell Games.  
END: 57

Locations: Buu's Intestines

GOKU

HP: -- Goku is a Saiyan from the planet Vegeta  
STR: -- that was stranded on Earth. He is an all-  
POW: -- around good guy, who often saves the Earth.  
END: --

Locations: --

GOON

HP: 1595 These tough guys have more muscles than  
STR: 40 brains.  
POW: 0  
END: 40

Locations: Thieves' Den  
Stolen Airship  
Diablo Desert  
Diablo Desert Express  
Pilaf's Castle

GOTEN

HP: -- Goten is the son of Goku and Chi-Chi. Despite  
STR: -- his young age, he is one of the most powerful  
POW: -- fighters in the universe.  
END: --

Locations: --

GUNMAN

-----  
| HP: 130 A known criminal, wanted on several counts of |  
| STR: 12 mischief and multiple counts of high jinks. |  
| POW: 13 |  
END: 19

| Locations: East Forest |  
| Hercule City |  
Musaka Circus

-----  
HERCULE

| HP: 20 The World Champion of Martial Arts. The |  
| STR: 5 world believes he was the one who defeated |  
| POW: 5 Cell, even though it was really Gohan. |  
| END: 5 Although a powerful martial artist in his |  
own right, he is no match for the Z-Fighters.

Locations: Papaya Island

-----  
HESSIAN

| HP: 800 A ruthless soldier of fortune. Armed with |  
| STR: 0 rocket propelled grenades. |  
| POW: 40 |  
END: 40

| Locations: Thieves' Den |  
| Stolen Airship |  
| Diablo Desert |  
Pilaf's Castle

-----  
HOOLIGAN

| HP: 560 A known criminal, wanted on several counts of |  
| STR: 22 chicanery, and multiple counts of shenanigans. |  
| POW: 0 |  
END: 34

| Locations: Thieves' Den |  
| Stolen Airship |  
| Diablo Desert |  
| Diablo Desert Express |  
| Pilaf's Castle |  
| Northern Wilderness |  
Volcano

-----  
HUMAN (NPC)

HP: ?? The Capsule Corporation database has no



STR: ?? information on this person.  
POW: ??  
END: ??

-----  
Locations: Hercule City  
West City  
Capsule Corp  
Papaya Island  
Diablo Desert Express  
Nataday Village  
-----

-----  
HUMAN (Fighters in the World Tournament's Junior Division)  
-----

HP: 850 The Capsule Corporation database has no  
STR: 11 information on this person.  
POW: 0  
END: 25

-----  
Locations: World Tournament Stadium  
-----

-----  
HYPER CYBORG  
-----

HP: 6225 Half-man... Half-machine... All deadly.  
STR: 58  
POW: 79  
END: 92

-----  
Locations: Barren Wasteland  
-----

-----  
IDASA  
-----

HP: 1320 An elementary school student who has made a  
STR: 13 name for himself in various junior martial  
POW: 0 arts tournaments.  
END: 28

-----  
Locations: World Tournament Stadium  
-----

-----  
JANEMBA  
-----

HP: 8880 The evil soul of an organized crime boss named  
STR: 0 Janemba has escaped and become this evil  
POW: 0 creature.  
END: 70

-----  
Locations: HFIL  
-----

-----  
JANEMBA HAND  
-----

HP: 50 Be careful of the hand of Janemba that travels

STR: 35 through a dimensional portal.  
POW: 0  
END: 0

Locations: HFIL

JEWL

HP: ?? Jewl is a popular martial artist.  
STR: ??  
POW: ??  
END: ??

Locations: World Tournament Stadium

Juggernaut

HP: 1552 Battle tanks are fully armored in 2 inch  
STR: 29 plates of geromatium. These tanks are armed  
POW: 60 with a 120mm cannon.  
END: 125

Locations: Thieves' Den  
Northern Wilderness

KIBITO

HP: ?? Kibito is the body guard of the Supreme Kai.  
STR: ??  
POW: ??  
END: ??

Locations: World Tournament Stadium

KID BUU

HP: 125000 Although he looks like a child, Kid Buu is  
STR: 66 actually the most dangerous of all Buu's many  
POW: 110 forms.  
END: 100

Locations: Planet of the Kais

KILLA

HP: ?? Killa is a martial artist.  
STR: ??  
POW: ??  
END: ??

| Locations: World Tournament Stadium |

-----  
| KING KAI |

| HP: ?? This guardian of the North Galaxy is known |  
| STR: ?? as one of the greatest martial arts trainers |  
| POW: ?? in the universe, and his corny sense of |  
| END: ?? humor. |

-----  
| Locations: Snakeway |  
| King Yemma's Office |  
| Grand Kai's Mansion |

-----  
| KING YEMMA |

| HP: ?? King Yemma is a giant ogre who guards the |  
| STR: ?? entrance to the Other World. |  
| POW: ?? |  
| END: ?? |

-----  
| Locations: King Yemma's Office |

-----  
| KNIGHT DESTROYER |

| HP: 5656 The Destroyer's nastier, stronger, and meaner |  
| STR: 45 older brother. |  
| POW: 0 |  
| END: 62 |

-----  
| Locations: Northern Wilderness |  
| Volcano |

-----  
| KORIN |

| HP: ?? Korin is a wise martial artist cat who lives |  
| STR: ?? at the top of Korin's Tower. |  
| POW: ?? |  
| END: ?? |

-----  
| Locations: Kami's Lookout (Korin's Tower) |

-----  
| KRILLIN |

| HP: ?? Krillin is an old friend of Goku's. They |  
| STR: ?? trained together under Master Roshi. Krillin |  
| POW: ?? is married to Android #18. |  
| END: ?? |

-----  
| Locations: Roshi's Island |  
| Papaya Island |

LASER TURRET

HP: 950     These advanced megawatt class chemical laser  
STR: 0     gunss are quite dangerous.  
POW: 28  
END: 32

Locations: Babidi's Ship  
          Airship

LICH

HP: 2500    The bones of the dead are animated by an  
STR: 46     unseen force.  
POW: 0  
END: 50

Locations: HFIL

MAD BOMBER

HP: 585     A bomber armed with dangerous explosives.  
STR: 17     Approach with extreme caution.  
POW: 35  
END: 35

Locations: Thieves' Den  
          Stolen Airship  
          Diablo Desert  
          Diablo Desert Express  
          Pilaf's Castle  
          Northern Wilderness

MAJIN BUU (Fight 1)

HP: 14640   An evil creature created by Bibidi many  
STR: 37     ages ago. Although he is child-like, his  
POW: 40     extreme power, underdeveloped sense of  
END: 55     right and wrong, and rubbery indestructable  
          body make him a dangerous adversary.

Locations: Giant Crater

MAJIN BUU (Fight 2 & 3)

HP: 45000   An evil creature created by Bibidi many  
STR: 42     ages ago. Although he is child-like, his  
POW: 38     extreme power, underdeveloped sense of  
END: 65     right and wrong, and rubbery indestructable

body make him a dangerous adversary.

Locations: West City

MAJIN FIGHTER

HP: 500 A martial artist who has been converted over  
STR: 18 over to Babidi's side.  
POW: 0  
END: 31

Locations: Southwest Forest  
Babidi's Ship

MAJIN SOLDIER

HP: 575 One of Babidi's Majin Henchmen from an unknown  
STR: 0 unknown alien species.  
POW: 27  
END: 33

Locations: Southwest Forest  
Babidi's Ship

MAJIN SHIELD SOLDIER

HP: 1000 This Majin Soldier will block your attacks with  
STR: 0 his shield.  
POW: 28  
END: 50

Locations: Babidi's Ship

MAJIN VEGETA

HP: 8500 Vegeta has been taken over by Babidi's Majin  
STR: 22 powers.  
POW: 25  
END: 36

Locations: Rocky Canyon

MARAUDER

HP: 1685 A ruthless soldier of fortune. Armed with  
STR: 0 rocket propelled grenades.  
POW: 75  
END: 52

Locations: Northern Wilderness

MARRON

HP: ?? Marron is the daughter of Krillin & Android 18  
STR: ??  
POW: ??  
END: ??

Locations: Roshi's Island

MASTER ROSHI

HP: ?? Master Roshi is a master of martial arts who  
STR: ?? trained Goku and Krillin. He is also known as  
POW: ?? the Turtle Hermit.  
END: ??

Locations: Roshi's Island  
Papaya Island

MECHANOID

HP: 2325 This cyborg transforms into a metal ball.  
STR: 24  
POW: 0  
END: 52

Locations: Airship

MERCENARY

HP: 160 A ruthless soldier of fortune. Armed with  
STR: 0 rocket propelled grenades.  
POW: 21  
END: 20

Locations: East Forest  
Hercule City  
Musaka Circus  
Stolen Airship

METAL HULK

HP: 17375 The Destroyer's nastier, stronger, and meaner  
STR: 77 older brother.  
POW: 0  
END: 70

Locations: Northern Wilderness  
Volcano

-----  
|  
MINI-YAKON

| HP: 1475 Janemba creates these miniature versions of  
| STR: 20 himself.  
| POW: 0  
END: 56

Locations: HFIL

-----  
|  
MINI-YAKON

| HP: 850 These aliens are like miniature versions of  
| STR: 20 Yakon.  
| POW: 16  
END: 38

Locations: Yakon's Planet (Babidi's Ship)

-----  
|  
MONK

| HP: ?? One of the monks in charge of running the  
| STR: ?? World Tournament.  
| POW: ??  
END: ??

Locations: Papaya Island

-----  
|  
MR. POPO

| HP: ?? Mr. Popo is Dende's right hand man. He has  
| STR: ?? lived on Kami's Lookout for countless ages.  
| POW: ??  
END: ??

Locations: Kami's Lookout

-----  
|  
MRS. BRIEF

| HP: ?? Mrs. Brief is Dr. Brief's wife, and Bulma's  
| STR: ?? mother.  
| POW: ??  
END: ??

Locations: Capsule Corp

-----  
|  
MUMMY

HP: 784 From the ancient sands of time these mummies  
STR: 24 awaken to curse the living.  
POW: 20  
END: 34

Locations: Diablo Desert  
Kyodai Pyramid

#### MUSAKA

HP: ?? Musaka is the ringmaster of the Musaka Circus.  
STR: ??  
POW: ??  
END: ??

Locations: Hercule City  
Musaka Circus

#### NINJA

HP: 585 A ninja. These warriors value stealth and  
STR: 20 subterfuge. Some ninja use their ninjitsu  
POW: 23 skills for assassination and thieving.  
END: 25

Locations: Ninja Stronghold

#### NINJA BOSS

HP: 5770 A ninja. These warriors value stealth and  
STR: 36 subterfuge. Some ninja use their ninjitsu  
POW: 23 skills for assassination and thieving.  
END: 25

Locations: Ninja Stronghold

#### NOSFERATU

HP: 2975 These undead monsters thrive off the  
STR: 0 blood of the living.  
POW: 27  
END: 53

Locations: HFIL

#### OLIBU

HP: 565 Olibu is an Other World Fighter, originally  
STR: 13 from Earth. Many of Earth's legends are  
POW: 0 based off of him.



END: 21

Locations: Grand Kai's Planet  
Cave of Ancients

OOLONG

HP: ?? Oolong is a friend of the Z-Fighters. He has  
STR: ?? the power to shape shift.  
POW: ??  
END: ??

Locations: Papaya Island

OX KING

HP: ?? Ox King is the father of Chi-Chi.  
STR: ??  
POW: ??  
END: ??

Locations: Papaya Island

PHANTOM

HP: 940 These spirits come from the Other World to  
STR: 17 haunt the living.  
POW: 0  
END: 43

Locations: Northern Wilderness

PHAROAH TOTENHOTEP

HP: 7320 From the ancient sands of time these mummies  
STR: 0 awaken to curse the living.  
POW: 26  
END: 55

Locations: Kyodai Pyramid

PICCOLO

HP: ?? Once an evil villain, Piccolo has seen the  
STR: ?? error of his ways and is now one of Earth's  
POW: ?? greatest heroes. Piccolo is an alien from  
END: ?? the planet Namek.

Locations: ---

PICCOLO (CLONE)

HP: 75000 Once an evil villain, Piccolo has seen the  
STR: 63 error of his ways and is now one of Eath's  
POW: 70 greatest heroes. Piccolo is an alien from  
END: 57 the planet Namek.

Locations: Buu's Intestines

PIKKON

HP: 950 A Powerful and respected alien warrior in the  
STR: 14 Other World.  
POW: 14  
END: 30

Locations: Otherworld Stadium

PILAF'S GUARDIAN

HP: 10605 The Destroyer's nastier, stronger, and meaner  
STR: 38 older brother.  
POW: 0  
END: 62

Locations: Pilaf's Castle

PINTAR

HP: ?? Pintar is a martial artist.  
STR: ??  
POW: ??  
END: ??

Locations: World Tournament Stadium

POLTERGEIST

HP: 2405 These spirits come from the Other World to  
STR: 34 haunt the living.  
POW: 0  
END: 45

Locations: HFIL

POWER MECHANOID

HP: 10521 This cyborg transforms into a metal ball.

STR: 82  
POW: 0  
END: 115

Locations: Barren Wasteland

#### PUAR

HP: ?? Puar is a shapeshifting cat and a constant  
STR: ?? companion of Yamcha.  
POW: ??  
END: ??

Locations: Papaya Island

#### PUIPUI

HP: 50 PuiPui is an alien from the planet Zoon and  
STR: 15 also a henchman of Babidi.  
POW: 15  
END: 10

Locations: Babidi's Shio

#### RAPSCALLION

HP: 1425 A known criminal, wanted on several counts of  
STR: 45 chicanery and multiple counts of shenanigans.  
POW: 0  
END: 55

Locations: Northern Wilderness

#### RONIN

HP: 1765 Although many of these ancient warriors live  
STR: 47 by the code of Bushido, they should be  
POW: 0 considered highly dangerous. Samurai are known  
END: 50 for their devastating sword attacks.

Locations: Volcano

#### SAMURAI

HP: 2175 Although many of these ancient warriors live  
STR: 22 by the code of Bushido, they should be  
POW: 0 considered highly dangerous. Samurai are known  
END: 38 for their devastating sword attacks.

Locations: Ninja Stronghold

-----  
|  
SCIENTIST

| HP: ?? A man of science! |  
| STR: ?? |  
| POW: ?? |  
END: ??

| Locations: Orange Star High School |  
| Capsule Corporation |  
Kyodai Pyramid

-----  
SHARPNER

| HP: ?? Sharpner attends Orange Star High School with |  
| STR: ?? Gohan. |  
| POW: ?? |  
END: ??

Locations: Orange Star High School

-----  
SHINOBI

| HP: 1585 A ninja. These warriors value stealth and |  
| STR: 44 subterfuge. Some ninja use their ninjitsu |  
| POW: 58 skills for assassination and thieving. |  
END: 50

Locations: Northern Wilderness

-----  
SKELETON

| HP: 775 The bones of the dead are animated by an |  
| STR: 21 unseen force. |  
| POW: 0 |  
END: 39

| Locations: Pilaf's Castle |  
| Kyodai Pyramid |  
Northern Wilderness

-----  
SNIPER

| HP: 612 A known criminal, wanted on several counts of |  
| STR: 15 mischief, and multiple counts of high jinks. |  
| POW: 31 |  
END: 36

| Locations: Thieves' Den |  
Diablo Desert Express

Pilaf's Castle

SOUL

HP: ?? This is a spirit that lives in the Other World  
STR: ??  
POW: ??  
END: ??

Locations: Snakeway  
King Yemma's Office

SPOPOVICH (Gohan Fight)

HP: 1855 This martial artist fought against Hercule in the  
STR: 22 24th World Tournament. There appears to be  
POW: 0 something strange about him...  
END: 25

Locations: World Tournament Stadium

SPOPOVICH (Videl Fight)

HP: 225 This martial artist fought against Hercule in the  
STR: 15 24th World Tournament. There appears to be  
POW: 0 something strange about him...  
END: 25

Locations: World Tournament Stadium

SUPER BUU

HP: 35330 When Majin Buu was absorbed by the mysterious  
STR: 47 Evil Buu, the Evil Buu transformed into this  
POW: 70 new, dangerous form.  
END: 55

Locations: Hyperbolic Time Chamber  
Kami's Lookout  
Great Crater

SUPER BUU (CLONE)

HP: 100000 When Majin Buu was absorbed by the mysterious  
STR: 63 Evil Buu, the Evil Buu transformed into this  
POW: 90 new, dangerous form.  
END: 70

Locations: Buu's Brain

-----  
SUPER BUU 2

| HP: 105300 When Gotenks was absorbed by Super Buu, Super |  
| STR: 55 Buu transformed into this new form. |  
| POW: 75 |  
END: 65

Locations: Barren Wasteland

-----  
SUPER JANEMBA

| HP: 25840 Janemba has transformed into a faster and |  
| STR: 47 more dangerous form. |  
| POW: 70 |  
END: 55

Locations: HFIL

-----  
SUPREME KAI

| HP: ?? The Supreme Kai is the highest ranking |  
| STR: ?? Guardian of the universe. |  
| POW: ?? |  
END: ??

Locations: World Tournament Stadium

-----  
TANK

| HP: 576 Battle tanks are fully armored in 2 inch |  
| STR: 13 plates of geromatium. These tanks are armed |  
| POW: 30 with a 120mm cannon. |  
END: 75

Locations: Musaka Circus

-----  
THUG

| HP: 340 These tough guys have more muscles than |  
| STR: 24 brains. |  
| POW: 0 |  
END: 25

| Locations: Hercule City |  
| Musaka Circus |  
Stolen Airship

TRUNKS

HP: -- Trunks is the son of Vegeta and Bulma. Despite  
STR: -- his young age, he is one of the most powerful  
POW: -- fighters in the universe.  
END: --

Locations: --

VAMPIRE

HP: 750 These undead monsters thrive off the  
STR: 0 blood of the living.  
POW: 10  
END: 38

Locations: Pilaf's Castle

VEGETA

HP: -- Vegeta was once the prince of the Planet  
STR: -- Vegeta before it was destroyed by Frieza.  
POW: -- Although he was once a villain, he usually  
END: -- fights for the Z-Fighters now.

Locations: --

VIDEL

HP: ?? The crimefighting daughter of Hercule. She  
STR: ?? attends Orange Star High School with Gohan.  
POW: ??  
END: ??

Locations: Orange Star High School  
Papaya Island

VILLAGE PRIEST

HP: ?? The head shaman of Nataday Village.  
STR: ??  
POW: ??  
END: ??

Locations: Nataday Village

VLAD

HP: 1340 These undead monsters thrive off the  
STR: 0 blood of the living.

POW: 17

END: 53

Locations: Northern Wilderness

WEST KAI

HP: ?? This guardian of the West Galaxy has a fierce

STR: ?? fierce rivalry with King Kai.

POW: ??

END: ??

Locations: Otherworld Stadium

WORM BODY

HP: 5170 These worms live inside Buu's digestive

STR: 35 system.

POW: 0

END: 58

Locations: Buu's Stomach

WORM HEAD

HP: 7238 These worms live inside Buu's digestive

STR: 35 system.

POW: 0

END: 58

Locations: Buu's Stomach

YAMCHA

HP: ?? Yamcha was once known as the dreaded Desert

STR: ?? Desert Bandit of Diablo Desert. He's now one  
POW: ?? of the good guys.

END: ??

Locations: Papaya Island

YAMU

HP: 1476 There appears to be something strange about

STR: 20 this martial artist.

POW: 0

END: 23

Locations: World Tournament Stadium



-----  
YAJIROBE

| HP: ?? Yajirobe is a friend of the Z-Fighters. |  
| STR: ?? Although he carries a sword, he rarely uses it |  
| POW: ?? |  
END: ??

Locations: Kami's Lookout (Korin's Tower)

-----  
YAKON

| HP: 1725 A notorious monster from an alien planet of |  
| STR: 20 darkness. Has the power to absorb energy. |  
| POW: 68 |  
END: 41

Locations: Yakon's Planet (Babidi's Ship)

-----  
YEMMA'S ASSISTANT

| HP: ?? This assistant helps King Yemma usher souls |  
| STR: ?? into the Other World. |  
| POW: ?? |  
END: ??

Locations: King Yemma's Office

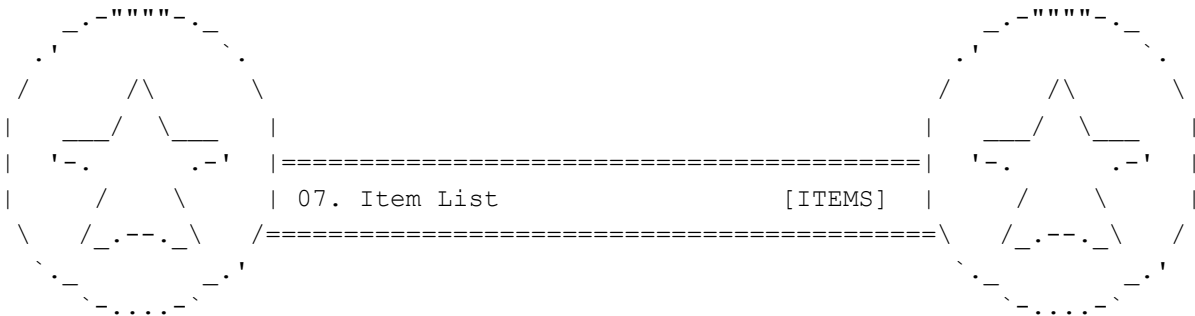

-----  
Supplies [SUPPL]

Name	Description
Cherry Soda	There's nothing like a good Cherry Soda!   Restores 175 EP.
Chicken Leg	It tastes like chicken! Restores 80 HP.
Cookie	Mrs. Brief's freshly baked chocolate chip   cookie. Restores 5HP.

Curry Plate	A dish of chicken and rice covered in spicy   curry sauce. Restores 400 HP.
Dinosaur Milk	Where does dinosaur milk come from? Restores   2500 EP.
Dinosaur Tail	They say the most succulent dinosaur meat comes   from the tail. Restores 1500 HP.
Elixer	A rare magical liquid that restores your   vitality!
Hamburger	A flame broiled and delicious hamburger.   Restores 120 HP.
Hercule-ade	Replenishes your precious electrolytes. Restores   350 EP.
Lazarus Crystal	A strange blue crystal. Some say carrying them   is good luck!
Milk	A carton of milk. Restores 20 EP.
Miso Soup	A tasty, yet nutritious soup. Restores 20 HP.
Onigiri	A traditional triangle of rice, wrapped in kelp.   Restores 200 HP.
Rice Ball	A small ball of sticky rice. Restores 40 HP.
Root Beer	A cool refreshing root eer. Restores 250 EP.
Soda	Now that's a tasty beverage! Restores 80 EP.
Steak	A medium-rare steak seasoned to perfection.   Restores 600 HP.
Super Elixer	The best magical elixer on the market. Restores   750 EP.
Tea	Care for a spot of tea? Restores 40 EP.
Three Course Meal	Are you sure you can eat that all by yourself?   Restores 1100 HP.
Turkey	A full sized turkey with stuffing. Restores   800 HP.
Vanilla Soda	Vanilla makes a good soda even better! Restores   125 EP.

_____	_____
__	[EQUIP]    __
_____	_____

=====  
Type: Hands                   STR: +0     POW: +0     END: +0     SPD: -5     REQ LVL: 50  
Description: Weighted armbands slow you down, but give you more experience  
as a reward.  
-----

-----  
2 Ton Armbands

=====  
Type: Hands                   STR: +0     POW: +0     END: +0     SPD: -8     REQ LVL: 70  
Description: Weighted armbands slow you down, but give you more experience  
as a reward.  
-----

-----  
10 Ton Armbands

=====  
Type: Hands                   STR: +0     POW: +0     END: +0     SPD: -10    REQ LVL: 90  
Description: Weighted armbands slow you down, but give you more experience  
as a reward.  
-----

-----  
100 Ton Armbands

=====  
Type: Hands                   STR: +0     POW: +0     END: +0     SPD: -20    REQ LVL: 130  
Description: Weighted armbands slow you down, but give you more experience  
as a reward.  
-----

-----  
1 Ton Boots

=====  
Type: Feet                    STR: +0     POW: +0     END: +0     SPD: -5     REQ LVL: 50  
Description: Weighted boots slow you down, but give you more experience as  
a reward.  
-----

-----  
2 Ton Boots

=====  
Type: Feet                    STR: +0     POW: +0     END: +0     SPD: -8     REQ LVL: 71  
Description: Weighted boots slow you down, but give you more experience as  
a reward.  
-----

-----  
10 Ton Boots

=====  
Type: Feet                    STR: +0     POW: +0     END: +0     SPD: -10    REQ LVL: 91  
Description: Weighted boots slow you down, but give you more experience as  
a reward.  
-----

-----  
100 Ton Boots

=====  
Type: Feet                    STR: +0     POW: +0     END: +0     SPD: -20    REQ LVL: 131  
Description: Weighted boots slow you down, but give you more experience as  
a reward.

-----  
-----  
Alligator Loafers

=====

Type: Feet                   STR: +0     POW: +0     END: +2     SPD: +5     REQ LVL: 100  
Description: These are some expensive shoes!

-----  
-----  
Amethyst Amulet

=====

Type: Accessories           STR: -3     POW: +4     END: -3     SPD: +0     REQ LVL: 80  
Description: This is an amulet made of Amethyst.

-----  
-----  
Armor of Darkness

=====

Type: Bows                   STR: +0     POW: +0     END: +15    SPD: +0     REQ LVL: 86  
Description: This magic armor makes your HP increase faster when you use  
melee attacks.

-----  
-----  
Bandana

=====

Type: Accessories           STR: +3     POW: +3     END: +3     SPD: +0     REQ LVL: 70  
Description: Only a really vicious criminal would wear something like this.

-----  
-----  
Blue Belt

=====

Type: Accessories           STR: +0     POW: +0     END: +15    SPD: +0     REQ LVL: 116  
Description: This is a blue karate belt.

-----  
-----  
Brass Knuckles

=====

Type: Hands                 STR: +9     POW: +0     END: +6     SPD: +0     REQ LVL: 85  
Description: A pair of brass knuckles.

-----  
-----  
Bronze Keiko

=====

Type: Body                  STR: +0     POW: +0     END: +6     SPD: -5     REQ LVL: 80  
Description: A traditional samurai scale armor made of bronze.

-----  
-----  
Brown Belt

=====

Type: Accessories           STR: +0     POW: +0     END: +17    SPD: +0     REQ LVL: 134  
Description: This is a brown karate belt.

Brute Coat

=====

Type: Body STR: +9 POW: +0 END: +13 SPD: +0 REQ LVL: 92

Description: The kind of coat a real tough guy might wear.

Charge Gloves

=====

Type: Hands STR: +13 POW: +0 END: +5 SPD: +0 REQ LVL: 108

Description: You can detect power flowing through these high tech gloves.

Clean Gi

=====

Type: Body STR: +0 POW: +10 END: +13 SPD: +0 REQ LVL: 90

Description: A gi so clean it shines!

Clean Shirt

=====

Type: Body STR: +0 POW: +5 END: +5 SPD: +0 REQ LVL: 62

Description: A shirt so clean it shines!

Cotton Gi

=====

Type: Body STR: +0 POW: +0 END: +1 SPD: +0 REQ LVL: 51

Description: A tunic made of a reflective material resistant to energy attacks.

Cotton Gloves

=====

Type: Hands STR: +1 POW: +0 END: +1 SPD: +0 REQ LVL: 50

Description: A pair of simple cotton gloves.

Cotton Tabi

=====

Type: Feet STR: +0 POW: +0 END: +1 SPD: +1 REQ LVL: 50

Description: Simple cotton Tabi boots.

Crisis Ring

=====

Type: Accessories STR: +5 POW: +2 END: +10 SPD: +0 REQ LVL: 132

Description: When you're about to die, this ring makes you stronger.

Crystal O-Yoroi

=====

Type: Body STR: +0 POW: +15 END: +15 SPD: +0 REQ LVL: 112

The crystals in this pendant increase the power of energy attacks.

-----  
-----  
Crystal Pendant

=====  
Type: Feet                   STR: +0     POW: +0     END: +38   SPD: +0     REQ LVL: 155  
Description: The crystals in this armor make your energy attacks stronger.

-----  
-----  
Demon Mask

=====  
Type: Accessories           STR: +0     POW: +0     END: +1     SPD: +0     REQ LVL: 50  
Description: This is a terrifying looking mask.

-----  
-----  
Diamond Armor

=====  
Type: Body                   STR: +0     POW: +0     END: +35   SPD: -12   REQ LVL: 145  
Description: A chestplate carved out of a giant diamond.

-----  
-----  
Diamond Gauntlets

=====  
Type: Hands                   STR: +18    POW: +0     END: +16   SPD: +0     REQ LVL: 132  
Description: A pair of gauntlets carved from a diamond.

-----  
-----  
Diamond Amulet

=====  
Type: Accessories           STR: +0     POW: +20    END: +0     SPD: +0     REQ LVL: 145  
Description: This is an amulet made of diamond.

-----  
-----  
Dirty Belt

=====  
Type: Accessories           STR: +0     POW: +0     END: +1     SPD: +0     REQ LVL: 50  
Description: Maybe you should get this belt cleaned before you wear it.

-----  
-----  
Dirty Cape

=====  
Type: Accessories           STR: +7     POW: -5     END: +9     SPD: +0     REQ LVL: 76  
Description: Maybe you should get this cape cleaned before you wear it.

-----  
-----  
Dirty Gi

=====  
Type: Body                   STR: +0     POW: +0     END: +1     SPD: +0     REQ LVL: 50  
Description: Maybe you should get these gloves cleaned before you wear them.

Dirty Gloves

=====

Type: Hands STR: +0 POW: +0 END: +1 SPD: +0 REQ LVL: 50

Description: Maybe you should get this gi cleaned before you wear it.

-----  
Dirty Shirt

=====

Type: Body STR: +0 POW: +0 END: +1 SPD: +0 REQ LVL: 50

Description: Maybe you should get this shirt cleaned before you wear it.

-----  
Do-Maru of Shadows

=====

Type: Body STR: +0 POW: -5 END: +20 SPD: +0 REQ LVL: 99

Description: A traditional samurai armor that is good for stealth.

-----  
Doom Amulet

=====

Type: Accessories STR: +10 POW: +0 END: +20 SPD: +0 REQ LVL: 95

Description: There's an evil aura around this amulet.

-----  
Dragon Armor

=====

Type: Body STR: +0 POW: +0 END: +26 SPD: +0 REQ LVL: 140

Description: Armor made from the scales of a dragon. Reduces the cost of energy attacks.

-----  
Eldrith Cameo

=====

Type: Accessories STR: -10 POW: -10 END: +30 SPD: +0 REQ LVL: 140

Description: This carving of unfathomable age is etched in a long forgotten ancient language.

-----  
Emerald Amulet

=====

Type: Accessories STR: +0 POW: +12 END: +0 SPD: +0 REQ LVL: 95

Description: This is an amulet made of emerald.

-----  
Fancy Wardrobe

=====

Type: Body STR: +0 POW: +0 END: +2 SPD: +0 REQ LVL: 69

Description: This suit is expensive looking.

-----  
Flippers

=====

Type: Feet STR: +0 POW: +0 END: +0 SPD: +20 REQ LVL: 113  
Description: These flippers help you catch better fish.

Force Suit

Type: Body STR: +18 POW: +5 END: +25 SPD: +0 REQ LVL: 139  
Description: This suit is imbued with the power of science.

Geromantium Bandana

Type: Accessories STR: +0 POW: +0 END: +40 SPD: +0 REQ LVL: 168  
Description: A bandana made of Geromantium.

Geromantium Gloves

Type: Hands STR: +25 POW: +0 END: +20 SPD: +0 REQ LVL: 170  
Description: A pair of gloves made of Geromantium.

Geromantium Kataginu

Type: Body STR: +0 POW: +40 END: +0 SPD: +0 REQ LVL: 175  
Description: A traditional samurai clothing made of Geromantium.

Geromantium Tabi

Type: Feet STR: +0 POW: +0 END: +25 SPD: +28 REQ LVL: 165  
Description: Tabi boots made of Geromantium.

"Gokuu" Hat

Type: Accessories STR: +0 POW: +0 END: +5 SPD: +0 REQ LVL: 100  
Description: If you wear this while you level up, you'll get a bonus!

Gold Boots

Type: Feet STR: +0 POW: +0 END: +17 SPD: +15 REQ LVL: 135  
Description: Boots made of gold.

Green Belt

Type: Accessories STR: +0 POW: +0 END: +10 SPD: +0 REQ LVL: 82  
Description: This is a green karate belt.



-----  
Halloween Costume

=====

Type: Accessories      STR: +0      POW: +0      END: +12      SPD: +0      REQ LVL: 85  
Description: It's a scary Halloween costume.

-----  
Hare's Foot

=====

Type: Accessories      STR: -1      POW: -1      END: -1      SPD: -1      REQ LVL: 81  
Description: This item looks like a rabbit's foot... but it's not real.

-----  
Jade Keiko

=====

Type: Body              STR: +10      POW: +0      END: +0      SPD: +0      REQ LVL: 88  
Description: A traditional samurai scale armor made of jade that reduces damage done while blocking.

-----  
Iron Armor

=====

Type: Body              STR: +0      POW: +0      END: +11      SPD: -10      REQ LVL: 92  
Description: A chestplate made of iron.

-----  
Iron Kabuto

=====

Type: Accessories      STR: +0      POW: +0      END: +10      SPD: +0      REQ LVL: 96  
Description: A traditional samurai helmet made of iron.

-----  
Kiloton Armbands

=====

Type: Hands             STR: +0      POW: +0      END: +0      SPD: -25      REQ LVL: 150  
Description: Weighted armbands slow you down, but give you more experience as a reward.

-----  
Kiloton Boots

=====

Type: Feet              STR: +0      POW: +0      END: +0      SPD: -25      REQ LVL: 150  
Description: Weighted boots slow you down, but give you more experience as a reward.

-----  
Leather Jacket

=====

Type: Body              STR: +0      POW: +0      END: +5      SPD: +0      REQ LVL: 55  
Description: A cool looking leather jacket.

-----  
-----

Leather Gloves

=====

Type: Hands STR: +1 POW: +0 END: +0 SPD: +0 REQ LVL: 72

Description: Gloves made of tough leather.

Leather Moccasins

=====

Type: Feet STR: +0 POW: +0 END: +4 SPD: +8 REQ LVL: 65

Description: Moccasins made of thick tanned leather.

Lucky Charm

=====

Type: Accessories STR: +0 POW: +0 END: +1 SPD: +0 REQ LVL: 58

Description: This charm gives you good luck!

Magician's Gloves

=====

Type: Hands STR: +7 POW: +0 END: 5 SPD: +0 REQ LVL: 107

Description: These magic gloves reduce the cost of an energy block.

Mercury's Cap

=====

Type: Accessories STR: +0 POW: +0 END: +12 SPD: +20 REQ LVL: 122

Description: The legendary cap of Mercury.

Mystic Aegis

=====

Type: Body STR: +0 POW: +0 END: +16 SPD: +0 REQ LVL: 96

Description: A mystical chestplate that reduces the cost of the energy block.

Ox-King's Hat

=====

Type: Accessories STR: +11 POW: +0 END: +10 SPD: +0 REQ LVL: 96

Description: This is the kind of viking hat that Ox-King is often seen wearing.

Pilaf's Gloves

=====

Type: Hands STR: +8 POW: +0 END: +6 SPD: +5 REQ LVL: 87

Description: Legend has it wearing these gloves will make you rich!

Platinum Gauntlets

=====

Type: Hands STR: +16 POW: +0 END: +10 SPD: +0 REQ LVL: 119

Description: A pair of Gauntlets made of platinum.

-----  
-----  
Polka-dot Kazoo

=====

Type: Accessories      STR: +0      POW: +0      END: +0      SPD: +0      REQ LVL: 96  
Description: This is a very silly kazoo.

-----  
-----  
Primordial Twisty Straw

=====

Type: Accessories      STR: +0      POW: +0      END: +2      SPD: +0      REQ LVL: 50  
Description: Drinks taste better when you use this ancient straw.

-----  
-----  
Prototype Energy Gloves

=====

Type: Hands              STR: +1      POW: +0      END: +0      SPD: +0      REQ LVL: 50  
Description: It's a prototype, so it isn't working yet.

-----  
-----  
Prototype Space Armor

=====

Type: Accessories      STR: +0      POW: +0      END: +1      SPD: +0      REQ LVL: 50  
Description: It's a prototype, so it isn't working yet.

-----  
-----  
Pure Black Cape

=====

Type: Accessories      STR: +0      POW: +0      END: +13      SPD: +0      REQ LVL: 89  
Description: How much more black could this cape be? The answer is none.

-----  
-----  
Quartz Amulet

=====

Type: Accessories      STR: +0      POW: +0      END: +2      SPD: +0      REQ LVL: 60  
Description: This is an amulet made of Quartz.

-----  
-----  
Red Belt

=====

Type: Accessories      STR: +0      POW: +0      END: +9      SPD: +0      REQ LVL: 75  
Description: This is a red karate belt.

-----  
-----  
Reflective Gloves

=====

Type: Hands              STR: +3      POW: +0      END: +5      SPD: +6      REQ LVL: 67  
Description: A pair of gloves made of reflective material resistant to energy attacks.

-----  
-----

Reflective Tunic

=====

Type: Body STR: +0 POW: +0 END: +3 SPD: +0 REQ LVL: 60

Description: A tunic made of a reflective material resistant to energy attacks.

Rhinestone Sunglasses

=====

Type: Accessories STR: +0 POW: +0 END: +2 SPD: +0 REQ LVL: 50

Description: These are some really tacky looking sunglasses.

Saiyan Gloves

=====

Type: Hands STR: +20 POW: +0 END: +0 SPD: +0 REQ LVL: 152

Description: Gloves like the Saiyans once wore.

Sapphire Amulet

=====

Type: Accessories STR: -3 POW: +7 END: -3 SPD: +0 REQ LVL: 86

Description: This is an amulet made of sapphire.

Scuba Gloves

=====

Type: Hands STR: +15 POW: +0 END: +0 SPD: +0 REQ LVL: 140

Description: These gloves help you catch better fish.

Silver Boots

=====

Type: Feet STR: +0 POW: +0 END: +14 SPD: +20 REQ LVL: 122

Description: Boots made of silver.

Silvery Boots

=====

Type: Feet STR: -1 POW: -1 END: -1 SPD: -1 REQ LVL: 131

Description: They look like silver boots but the paint is scratching off.

Silver Gauntlets

=====

Type: Hands STR: +12 POW: +0 END: +8 SPD: +0 REQ LVL: 105

Description: A pair of gauntlets made of silver.

Skull Ring

=====

Type: Accessories STR: +0 POW: +11 END: +12 SPD: +0 REQ LVL: 87

Description: This breastplate is covered with sharp spikes.

-----  
-----  
Spiked Breastplate

=====  
Type: Body                   STR: +0     POW: +0     END: +12   SPD: +0     REQ LVL: 95  
Description: This breastplate is covered with sharp spikes.

-----  
-----  
Spirit Geta

=====  
Type: Body                   STR: +5     POW: +15    END: -10   SPD: +15   REQ LVL: 102  
Description: There is a mysterious supernatural aura around these sandals.

-----  
-----  
Snorkel

=====  
Type: Accessories           STR: +8     POW: +0     END: +10   SPD: +0     REQ LVL: 83  
Description: This snorkel helps you catch better fish.

-----  
-----  
Stone Geta

=====  
Type: Feet                   STR: +0     POW: +0     END: +5     SPD: +12   REQ LVL: 98  
Description: Sandals made of stone.

-----  
-----  
Stone Men-po

=====  
Type: Accessories           STR: +0     POW: +0     END: +5     SPD: +0     REQ LVL: 59  
Description: An armored samurai face mask made of stone.

-----  
-----  
Stone O-Yoroi

=====  
Type: Body                   STR: +0     POW: +0     END: +7     SPD: -12   REQ LVL: 72  
Description: A traditional samurai armor carved out of stone.

-----  
-----  
Super Cape

=====  
Type: Accessories           STR: +0     POW: +0     END: +16   SPD: +0     REQ LVL: 93  
Description: This cape has magic that makes Super Saiyan last longer.

-----  
-----  
Talisman of Light

=====  
Type: Accessories           STR: +9     POW: +10    END: +12   SPD: +0     REQ LVL: 95  
Description: This talisman increases the amount of energy recharged when you use melee attacks.

-----  
Titanium Breastplate

=====

Type: Body                   STR: +0     POW: +0     END: +36   SPD: +10   REQ LVL: 150  
Description: A breastplate made from titanium.

-----  
Topaz Amulet

=====

Type: Accessories           STR: +5     POW: +0     END: +0     SPD: +0     REQ LVL: 70  
Description: This is an amulet made of topaz.

-----  
Vampire Cape

=====

Type: Accessories           STR: +0     POW: +14    END: +25    SPD: +0     REQ LVL: 128  
Description: This cape causes HP to be recharged instead of energy when you use melee attacks.

-----  
Wet Suit

=====

Type: Body                   STR: +0     POW: +0     END: +25    SPD: +0     REQ LVL: 142  
Description: This suit helps you catch better fish.

-----  
White Belt

=====

Type: Accessories           STR: +0     POW: +0     END: +3     SPD: +0     REQ LVL: 50  
Description: This is a white Karate Belt.

-----  
Wooden Armor

=====

Type: Body                   STR: +0     POW: +0     END: +6     SPD: +0     REQ LVL: 63  
Description: Armor carved out of wood.

-----  
Wooden Geta

=====

Type: Feet                   STR: +0     POW: +0     END: +6     SPD: +15    REQ LVL: 84  
Description: Sandals made of wood.

-----  
Wool Cap

=====

Type: Accessories           STR: +0     POW: +0     END: +4     SPD: +0     REQ LVL: 54  
Description: A thick knitted wool cap.

-----  
Wool Mittens

=====



Soda	200 Z
Vanilla Soda	350 Z

Cotton Tabi	50 Z
Woolen Shoes	475 Z
Leather Moccasins	820 Z
Wool Cap	350 Z
Stone Men-po	600 Z
Topaz Amulet	840 Z
Lucky Charm	4500 Z

-----  
| | | West City Z-Mart | | |  
-----

Rice Ball	200 Z
Chicken Leg	400 Z
Hamburger	600 Z
Onigiri	1000 Z
Tea	100 Z
Soda	200 Z
Vanilla Soda	350 Z
Cherry Soda	575 Z

Wool Sweater	300 Z
Leather Jacket	495 Z
Wooden Armor	850 Z
Stone O-Yoroi	1480 Z
Cotton Gloves	50 Z
Wool Mittens	500 Z
Leather Gloves	1250 Z
Woolen Shoes	475 Z
Leather Moccasins	820 Z
Wooden Geta	2050 Z
Stone Men-po	600 Z
Topaz Amulet	840 Z
Red Belt	1925 Z
Lucky Charm	4500 Z

-----  
| | | Papaya Island Drink Stand | | |  
-----

Milk	50 Z
Tea	100 Z
Soda	200 Z



Vanilla Soda	350 Z
Cherry Soda	575 Z
Root Beer	950 Z

-----  
 | | Papaya Island Food Stand | | |  
 -----

Miso Soup	100 Z
Rice Ball	200 Z
Chicken Leg	400 Z
Hamburger	600 Z
Onigiri	1000 Z

-----  
 | | Papaya Island Gift Stand | | |  
 -----

Leather Gloves	1250 Z
Brass Knuckles	2210 Z
Leather Moccasins	820 Z
Wooden Geta	2050 Z
Lucky Charm	4500 Z
Red Belt	1925 Z
Topaz Amulet	840 Z
Blue Belt	4450 Z
Hercule Exhibit 24	25000 Z
Hercule Exhibit 25	50000 Z

-----  
 | | Thieves' Den Z-Mart | | |  
 -----

Chicken Leg	400 Z	Leather Jacket	495 Z
Hamburger	600 Z	Wooden Armor	850 Z

Onigiri	1000 Z	Stone O-Yoroi	1480 Z
Curry Plate	2000 Z	Bronze Keiko	2200 Z
Soda	200 Z	Wool Mittens	500 Z
Vanilla Soda	350 Z	Leather Gloves	1250 Z
Cherry Soda	575 Z	Brass Knuckles	2210 Z
Root Beer	950 Z	Leather Moccasins	820 Z
		Wooden Geta	2050 Z
		Stone Geta	3780 Z
		Wool Cap	350 Z
		Stone Men-po	600 Z
		Amethyst Amulet	1925 Z
		Lucky Charm	4500 Z

Planet of the Kai's Den Z-Mart

Steak	3000 Z	Dragon Armor	11855 Z
Turkey	4000 Z	Titanium Breastplate	12350 Z
Three Course Meal	5500 Z	Diamond Armor	14650 Z
Dinosaur Tail	7500 Z	Geromantium Kataginu	99999 Z
Hercule-ade	1350 Z	Diamond Gauntlets	6825 Z
Elixer	2500 Z	Scuba Gloves	11500 Z
Super Elixer	3750 Z	Kiloton Armbands	32650 Z
Dinosaur Milk	5000 Z	Geromantium Gloves	85480 Z
		Silver Boots	7300 Z
		Gold Boots	10250 Z
		Kiloton Boots	33695 Z
		Geromantium Tabi	50210 Z
		Brown Belt	3250 Z
		Mercury's Cap	7300 Z
		Diamond Amulet	12250 Z

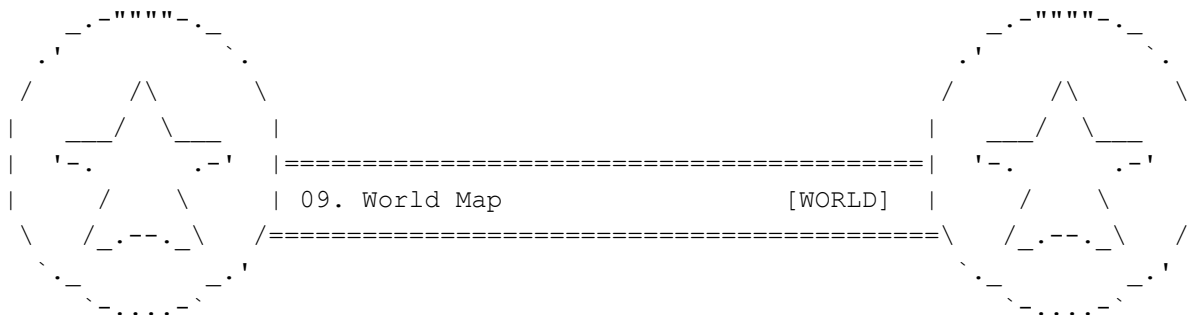

The following, is a rough map of the world. I'll admit that it isn't the best map, but it should be enough to get the job done. It has all the locations that you can enter labeled, with the exception of Rogue Submarines, and Stolen Airrafts - For the sole reason, that they are randomly generated, and are in different areas each time you enter the map. Also, take note, that the pirate airships are only available at certain times in the game.

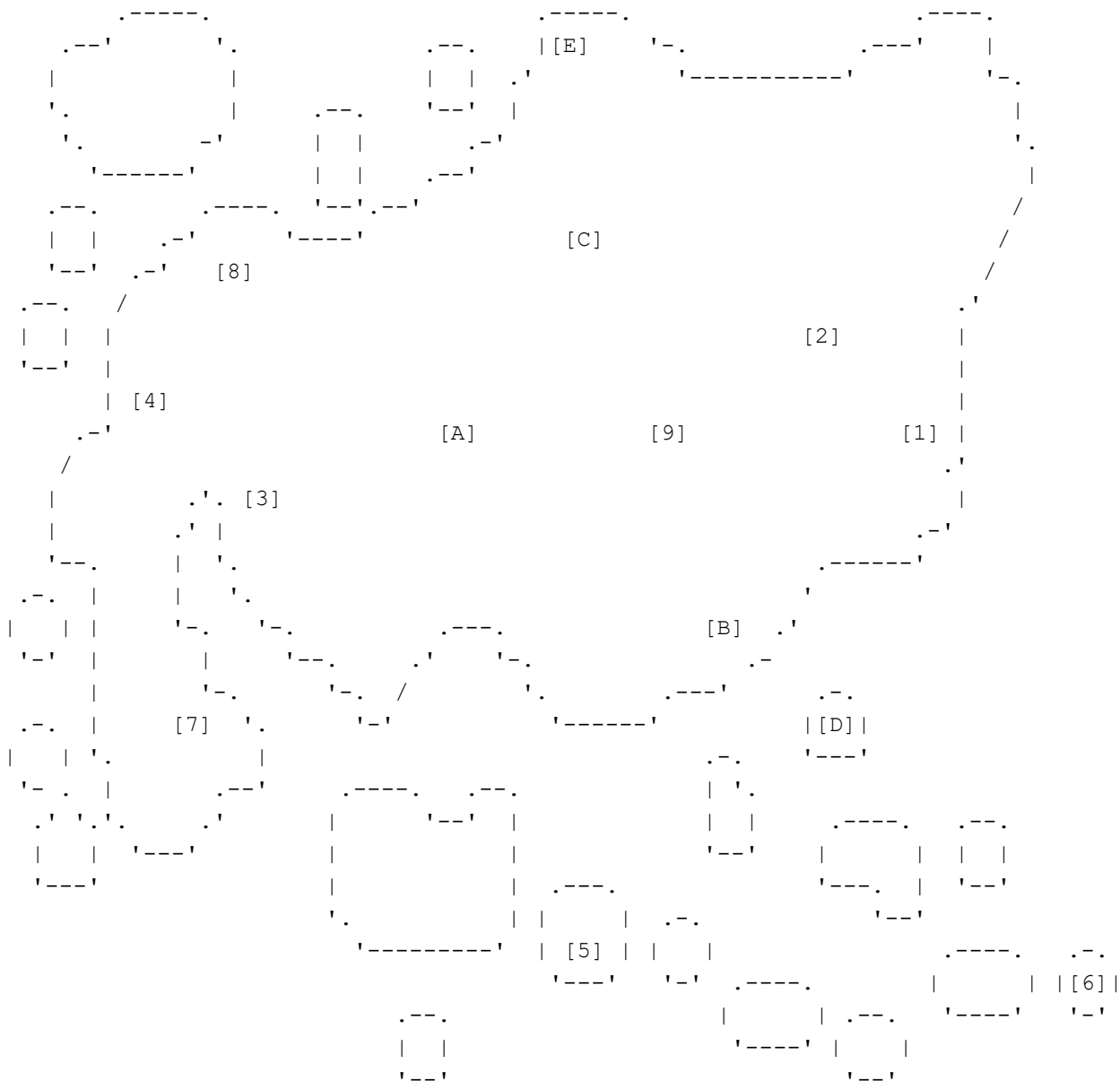

[1] East District 439  
 [2] Hercule City

[7] Southwest Forest  
 [8] Fukurou Forest

[D] Roshi's Island  
 [E] Airship

- |                    |                     |
|--------------------|---------------------|
| [3] West City      | [9] Kyodai Pyramid  |
| [4] Kami's Lookout | [A] Diablo Desert   |
| [5] Papaya Island  | [B] Pilaf's Castle  |
| [6] Thieves Den    | [C] Nataday Village |

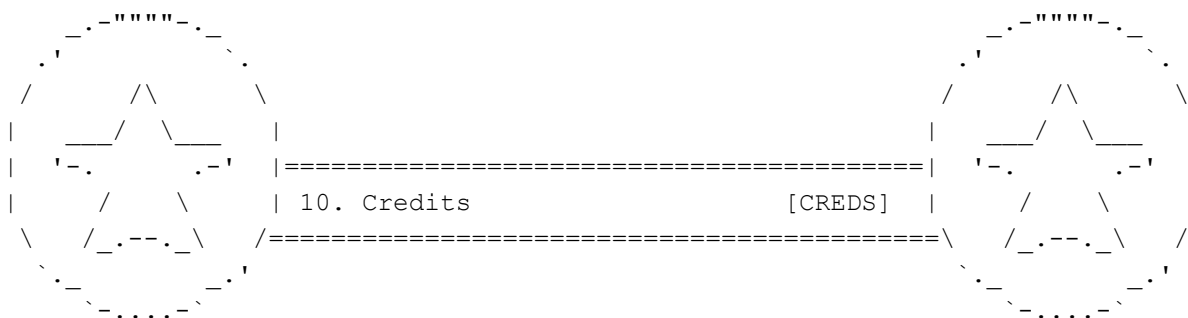

SayainPrince: - This is me. I wrote the guide.  
Joni Philips - Two enemy quotes I missed, I got from his FAQ.  
THayes - I checked a few item names with his FAQ.

Do you think this FAQ was useful? If so, please consider donating a small sum of money to my PayPal account. Any amount is appreciated!

[https://www.paypal.com/cgi-bin/webscr?cmd=\\_xclick&business=wahwahdo@verizon.net](https://www.paypal.com/cgi-bin/webscr?cmd=_xclick&business=wahwahdo@verizon.net)

This document is copyright SayainPrince and hosted by VGM with permission.