

Tomb Raider II: Dagger Of Xian FAQ/Walkthrough

by Shotgunnova

Updated on Nov 10, 2008

/| Spoiler-free FAQ & Walkthrough by Shotgunnova (P. Summers) |

| INDEX |

I. CONTROLS	CNTR
II. GENERAL INFO	GNRL
III. WALKTHROUGH	WLKT
01) The Great Wall	WK01
02) Venice	WK02
03) Bartoli's Hideout	WK03
04) Opera House	WK04
05) Offshore Rig	WK05
06) Diving Area	WK06
07) 40 Fathoms	WK07
08) Wreck of the Maria Doria	WK08
09) Living Quarters	WK09
10) The Deck	WK10
11) Tibetan Foothills	WK11
12) Barkhang Monestary	WK12
13) Catacombs of the Talion	WK13
14) Ice Palace	WK14
15) Temple of Xian	WK15
16) Floating Islands	WK16
17) The Dragon's Lair	WK17
18) Home Sweet Home	WK18
IV. APPENDICES	APPN
Secrets	SCRT
Enemies	ENMS
Cheats	CHTS
V. FREQUENTLY ASKED QUESTIONS	FAQZ
VI. UPDATES & CONTRIBUTIONS	UPDT
VII. LEGALITY	LGLT

I. CONTROLS

[CNTR]

L2 BUTTON --> /_____\ | | _____\ <-- R2 BUTTON

L1 BUTTON --> /_____\ _____| | ____/ _____\ <-- R1 BUTTON

/ _ | | _ _____| | ____/ _____\ <-- TRIANGLE BUTTON

This is a collection of general tips that'll help the player. If a reader has a good one, send it in and I'll put it here.

- **SAVE OFTEN.** This is probably the #1 best tip ever. If Lara gets in a bind later, just reset; if some weird noise is coming from an adjacent room, this is a way to prepare for it. The usual downside to saving is that if one gets in a bind with no way out, that ruins the game! Not so in this case. Unlike TR games that followed, Lara can reload the entire level should something go terribly awry, and there aren't many places where that's even possible. Learning when to save is the fast track to success, and usually helps conserve items, medipacks in particular.
- **CONSERVE AMMO.** Do you really need to shoot birds with grenade launchers? How about pumping uzi rounds into a spider? There are plenty of weapons that pack a punch but wasting them on generic baddies, such as clubthugs who have no ranged weapon, is just dumb. Case in point: during the last two levels (not counting Home Sweet Home) there are enemies that will need grenade/uzi/M16 rounds to be dealt with quickly. Using the infinite-ammo pistols works well almost all the time, especially when used in conjunction with the first tip -- a lot easier to know what's coming!
- **SURVEY THE AREA.** Using the look-around button (L1) often provides clues on where to go, and is helpful in spotting places one might not see. Consider this a must when searching for the dragon artifacts hidden on most levels. And although it's fairly obvious, don't waste flares unless Lara's in a dark place -- there are a few pitch-black rooms/caverns towards the end of the game.
- **SEARCH OUT SECRETS.** On all levels but the last two, there are artifacts of three types: silver, gold, jade. The order they appear differs from area to area, and they aren't useful on their own, but when the set is completed, Lara is rewarded with extra ammunition (or a gun, if she doesn't have it). Sometimes these require a little work but it's always helpful to have lots of ammunition, particularly towards the end of the game when grenades help a lot.
- Spike pits and glass shards pop up quite a lot in this game, and while they provide instant death if Lara falls on them from above, she can walk through them (with R1) harmlessly if they're on her level. Running through them or jumping out of them still damages however, but the latter is really negligible.

/ III. WALKTHROUGH - WLKT | _

01) THE GREAT WALL

[WK01]

NOTE: Numbers on the map represent secrets' location (and recommended order)

		START				Numbers (#s) denote the			
)	A	order secrets're gotten		A: Connected Passage	
				/				B: The Great Wall	
				/				C: Guardhouse	
		1		A		B		D: Boobytrapped Pool	
								E: Boulder Trap	
				J				F: Spikewall Trap	

3I				G: Spikewall Trap (x3)			
	H		G		D	H: Rolling Razorwheels	
			2			I: Zipline	
						J: Exit Door	
	F	E					

TIGER CAVE

Our gal starts the level by sliding into a cavern from a helicopter rope. She seems to have packed light -- her inventory only has one of each medipack, two Flares, and two Shotgun shells! No enemies are here yet, so quickly run to the small pool nearby and find a pull-up point against the wall. Snipe a tiger who's gotten loose below, then do a flatfoot diagonal jump from the ledge to the pillar, then around the corner. This should bring Lara to the "left" wall from where she entered the level. Climb up again, turn around, do a jump to the overhang. The SILVER DRAGON [1/3] on another overhang above the ledges below. By now, if you look around (L1 Button), the way upwards should be clear: there's an opening atop the climbing course we're doing. At the top, do a running jump over the slanted rock and land right by the entrance! There's nothing inside, although one corner has a grate that will immediately cave-in if Lara stands there -- do so.

The pool Lara falls into has some steps on one edge and a lever in a far corner. Do a running jump-n'-grab to pull up there, operating the device to unlock the door.

THE GREAT WALL

Exit onto the great wall and kill the three carrion birds who attack (one from behind after awhile). Part of the great wall has fallen away and now leads downwards to a vacant pool. Dive into it and find the crawlspace with the GUARDHOUSE KEY within. This unleashes a tiger above somehow -- scramble to high ground against the wall and kill it from there. Coincidentally, that high ground is also the way back up! Unlock the guardhouse with the new key.

GUARDHOUSE & TRAPS

Kill the tarantulas and find the RUSTY KEY up the ladder, which unlocks the old door below. Beyond, smoke smore more spiders and pick up the SHOTGUN SHELLS and LARGE MEDIPACK by the pathetic corpse. A pushable block disguises a doorway leading to a slide. This drops Lara off by a boobytrapped pool: razor-sharp discs will fly out of the walls and try to cut her up if she takes the obvious way through. Instead of wading, look for a crack along the long wall and grab on, shimmying over the bulk of the traps.

Climb up the passage beyond and save! The floor here crumbles and plummets Lara into spikes if she lollygags, so quickly enter the cavern beyond (this shuts the door). Boulders will roll in from the "left" so run to the "right," where the only entrance is. Jump over the spikes at the bottom to land in a hole with...more spikes! These ones are on walls and encroaching quickly, so climb into the sidepassage to evade 'em. This safe spot is a good place to save.

Quickly run along, jumping over the scythe traps and crumbling floor, until landing back in a room with spiked walls trying to make a Lara sandwich. Pick up the JADE DRAGON [2/3] quickly and run through the series of spikewalls, until sliding into a hole with a final one. Do a quick roll and find the old flooring that falls away, putting Lara in a safe passage once again. Save!

ZIPLINE CAVERN

In the cavern with rolling razorwheels, pick up the SMALL MEDIPACK and blaze through to the other end with a zipline. Kill all spiders here (I counted 5) and save. It's possible to descend into the canyon! Look for a drop-down point to a moss-covered platform, then shimmy across the crack to a pull-up spot. Beyond is FLARES, and a ladder that leads up (to zipline) and down (to cavern bottom). The lower way is dark so be careful.

There will be two skeletons beneath there. Approach them to hear something wicked this way come -- it's a t-rex, man! I suggest retreating to the passage with the ladder and shooting from there since it can't fight back. When it finally dies, collect the Gold Dragon [3/3] from the cave, hopefully receiving extra items as well: a GRENADE LAUNCHER (6 rounds) & SMALL MEDIPACK! The Grenade Launcher should be saved for a rainy day, particularly the game's final levels...don't waste it on scrubs! Q

Quickly run back to the ladder passage because another t-rex will be on the prowl and this one can enter the gold dragon niche! Climb the ladder back up to its apex and jump down near the zipline; this time, take it across to the opposite side (1-way). Destroy the tiger family

EXIT DOOR

Beyond the zipline area is a small cave with modern equipment around. Approach the door to leave. No more dark underground pits to walk in this time!

02) VENICE

[WK02]

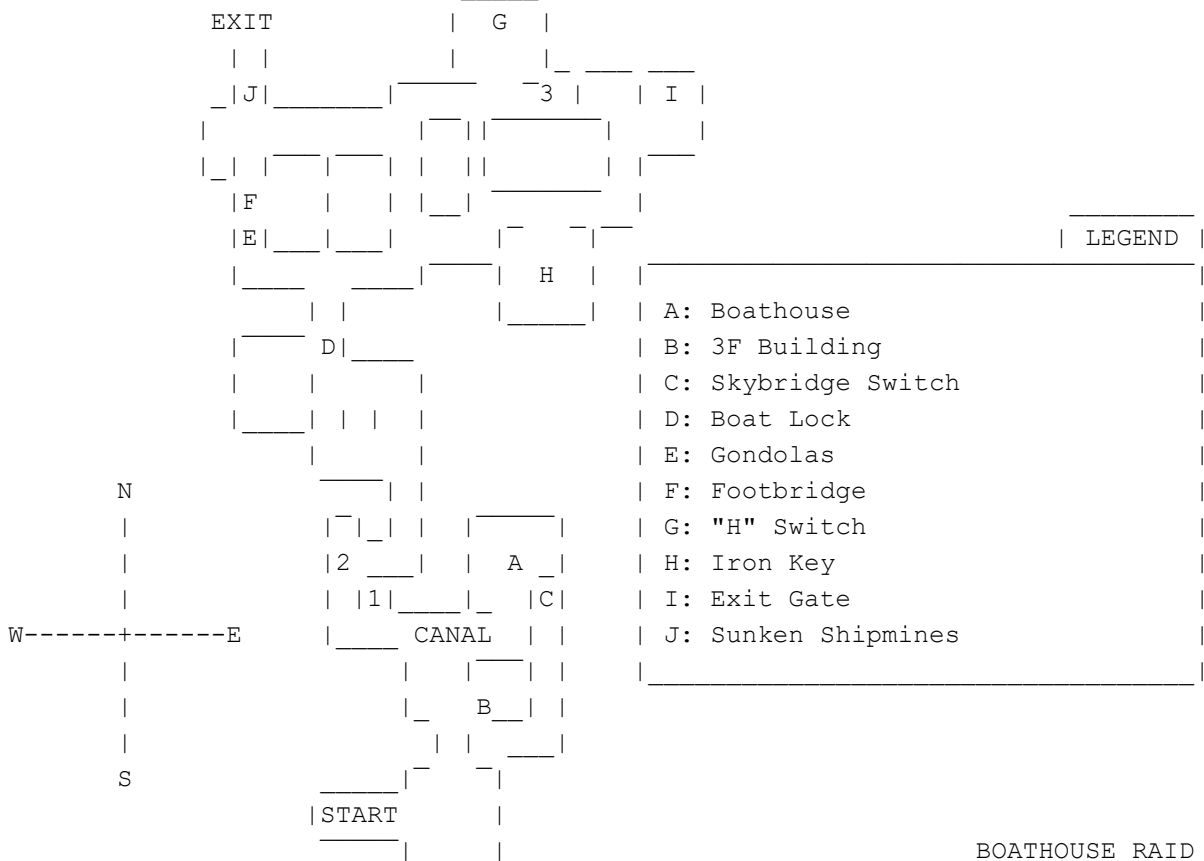

BOATHOUSE RAID

From the starting blind alley, continue to a small area underneath a balcony, which has a sniper up top. A doberman attacks en route, and another when Lara tries to use the adjacent alley to get a bead on the elevated attacker. Near the canal, a club-swinging henchman attacks...didn't he ever hear the maxim

"Never bring a club to a gunfight"? Either way, he drops a SMALL MEDIPACK. Swim underneath the wooden gate across the canal to find a boat (ignore for now) and a button that opens a door somewhere.

Back on dry land, enter the building the club-wielding thug emerged from and take the FLARES. The button here opens the 2F trapdoor, and up a level, that button opens the 3F trapdoor. On the roof, a larger building adjoins -- Lara can shoot out the window for a makeshift entrance. There will be a 3rd doberman in the building interior, and the already-broken window leads to the sniper's balcony. Pry the BOATHOUSE KEY from his cold fingers and flip the skybridge switch accessible from the doberman building, opening a wooden door over the canal accessible by the red awnings.

To get there, shoot out the window in the building connected to the skybridge (it's the only one unbroken), jumping from the sill to the awning. The lever in the newly-opened door pulls back the wooden gate sitting half-sunken in the canal. Once Lara re-enters the boathouse and uses the new key, it'll be possible to use the craft in the canal, too. Make sure to kill the new moron who appears; he drops AUTOMATIC PISTOLS a.k.a. Uzis. Drive the boat through the canal entrance now, and light a flare to see an alcove that contains the first secret [1/3], the SILVER DRAGON and FLARES. [The ladder here leads down to two rats and into a lower canal area; this is just to get the secret a different way since the boat won't be able to go back after a point.]

LOWER CANALS

Drive the boat until it falls over a dropoff, then disembark and swim down to the next secret [2/3], the GOLD DRAGON. Keep driving until Lara finds a locked canal gate and a ladder. There are sunken UZI CLIPS (x2) here, and they're easy to find with a flare in hand. Anyway, back to the gate dock.

Break into the window and kill the thug/rats who appear; the man drops AUTO PISTOL AMMO, plus there are SHOTGUN SHELLS near the locked door. Get back in the boat and drive it forward into the lock, then exit and swim back to the building. Use the switch inside to flood the lock, raising the boat's height to clear the ledge -- it's accessible via the ladder outside. To open the far gate, there is a sunken wall lever within this enclosed portion.

UPPER CANALS

Once out in the fresh air, hang a left to Point "E", where Lara can bust through a bunch of gondolas like a James Bond stuntman. There will be a thug near the docked speedboat, so get on dry land and snipe him from afar (he won't reciprocate) and take his two M16 CLIPS. The door he was guarding is locked and north of there are some visible landmines blocking the level exit. We'll have to go around!

Dock the boat by where the gondolas were and do a flatfoot jump-n'-grab to the red awning across the water. From here Lara can get access to a higher footbridge with a club-wielding henchman and a doberman, the former dropping a LARGE MEDIPACK. A third man will tote some guns around the corner, and he leaves the useful STEEL KEY to unlock the door nearby. There's a lever inside that raises a side-canal's gate, but one more is needed. Be prepared for a 3rd henchman upstairs who drops two sets of AUTO PISTOL AMMO.

This time, return to the entrance and hang a right down the thus-unused canal. A pistol thug can be seen on the dock right near the corner, so eliminate him 'fore he causes any harm (it's easiest to do this by swimming to it rather than jumping out of the boat, in my opinion). This sucker drops two packs of SHOTGUN SHELLS and a LARGE MEDIPACK!

Continue straight ahead, turning "right" to find another dock with 2 gondolas attached. This is point "G" on the map. The door is locked but if Lara steps foot on it, a clubthug emerges. Kill some rats inside and pull the lever to unlock a door at a dock elsewhere. Outside, see the nearest bridge overhead? Lara can climb up here, shoot the window, and get the JADE DRAGON [3/3], plus the reward of 4x AUTO PISTOL AMMO if that completes the set. There's metal mesh preventing further access through the canal, so use the boat and go back the way we came.

Near where the thug was walking on an isolated dock, take the perpendicular canal to the door opened a second ago (Point "H"). Inside, take the IRON KEY and find Lara locked in. The walls are notched and can be used as ladders, one corner of which leads to the 2F. Backflip off and neutralize the clubthug and doberman; a SMALL MEDIPACK is left in the aftermath. A switch opens the exit door, also unleashing another t-shirted henchman on the isolated dock below. Further down the canal, at Point "I", is a moron who will take potshots at Lara if she's in the boat and when swimming inside. He leaves AUTO PISTOL AMMO behind, and the button he guarded opens the level exit gate (behind the sunken landmines). Ignore the button for now, though.

Now, go back to the first part of the upper canals where the three gondolas were deep-sixed, and use the Steel Key on the door the thug was guarding. Inside, a henchman drops a SMALL MEDIPACK, while the tiny lever raises the 2nd alley gate -- this completes the shortcut. To get rid of the landmines, save and drive one of the boats towards them, then bail at the last second to survive. One of the motorboats won't, but there's a replacement right nearby!

REACHING THE EXIT

The exit should be cleared of landmines and the canal shortcut opened by this point. At "Point I" on the map, there's a button that opens the exit gate but gives a timer in the form of bell tolls. Lara must make it through before it stops, and the rest is self-explanatory. There are a few ways to do this:

- #1) The hardest: Ignore the Jade Dragon ramp and take the long way around to the exit. Actually, this way is impossible -- there's absolutely no way to make it there in 13 tolls (seconds). Even by going at breakneck speed the whole way, Lara's liable to come up short due to the canal angles.
- #2) The quickest: The ramp that led up to the Jade Dragon can be used as a workaround for the lower canal that has metal mesh blocking progress. From here, simply take the shortcut opened and reach the exit in time. It's easiest done if the boat is aligned and its back-end is touching the ramp Lara exits on foot -- this way she can hop in immediately when the bell peals start. [NOTE: To get up the ramp, more power is needed, so use forward + X-button]
- #3) The easiest: If Lara swims underneath the gate, the tolls (laughably) will not start. Take a scenic cruise to the finish line.

03) BARTOLI'S HIDEOUT

[WK03]



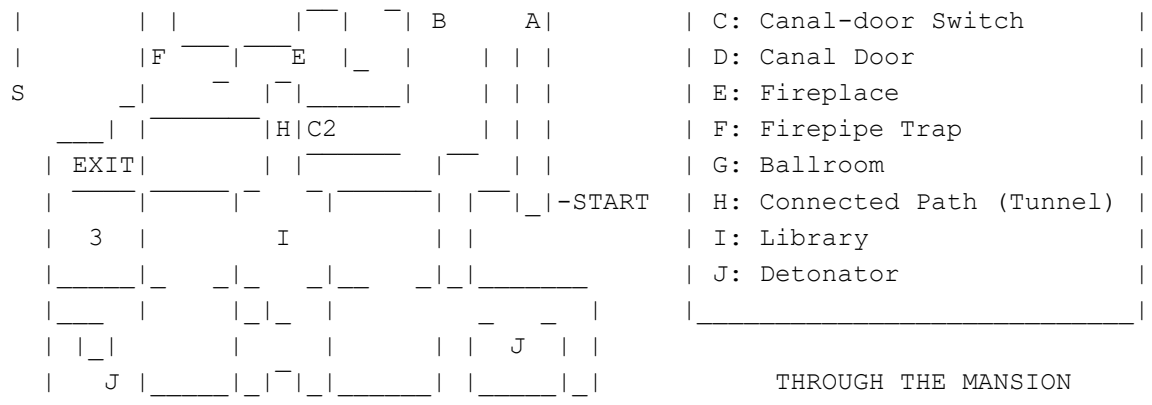

THROUGH THE MANSION

The final Venician boat level! The canal here is L-shaped and leads nowhere, so dock near the locked door and kill some disease-carrying rats. More of these pests plus a clubthug can be found upstairs a bit, dropping a LARGE MEDIPACK all the while. Kill some rats and find the wall switch, opening the door near the dock. A clubthug will rush to Lara, but can be neutralized with little fear of damage...and he drops a SMALL MEDIPACK!

Inside the foyer, there will be a gunman on the balcony and at ground-level. Run underneath the 2F walkway to avoid the upper thug's sights, then kill the lower for SHOTGUN SHELLS. Once the sniper above is dead, it's time to loot his corpse. There is a slanted wooden block that will give access to the (only) wooden balcony. From here, push the block with flower insignia until a straight-ahead running jump can land near the corpse -- AUTO PISTOL AMMO!

Before continuing, go downstairs and break the windows with the two dobermans behind. In one corner, there's FLARES, a SMALL MEDIPACK, and AUTO PISTOL AMMO to score. Back in the mansion, there's a dark hallway with three statues that drop swords. Unfortunately, this Tomb Raider doesn't allow crawling; just go through when they alternate the drops. At the end is a switch that opens a wooden door, canal-side.

Back up on the balcony (where sniper was), the wall there is notched and can allow Lara to reach an outer balcony. Kill the gunman across the way, then jump-n'-catch the red awning. Shimmy all the way across and pull up, holding the jump button to immediately backflip onto the next balcony. Jump to the next red awning and align with the lower canal door opened previously. A normal jump doesn't work here, but Lara can fall into the opening by holding X/Action button, which makes her less aerodynamic and lessens the jump arc. It can be hard so save first.

Further inside, nix the two dobermans and the masked pistol thug who appears in the adjacent room. Smash the balcony window, kill another fool there for two UZI CLIPS, and steel into the other room's window. Two clubthugs and a dog will do a lame pincer attack, coming in through the previously-locked double doors and the balcony, so take 'em out fast (protip: backflip shoot). No reward for this slaughter... Push the fireplace's block to find a secret passage beyond with a single rat. To get the secret [1/3] here, locate the switch in the empty room with a chandelier, opening a balcony path overlooking the canal. The gunman killer earlier will have dropped SHOTGUN SHELLS, plus there's a SILVER DRAGON to take! Anyway, back to the fireplace passage. Save before sliding down the ramp.

Two lateral bladetrap spring during the descent, so try your best to jump over 'em...or jump into the water below and avoid the hassle. The fire pipe trap here here is shut off by standing on the wooden block before the first, and it's on a timer naturally. Flatfoot jumps can clear it easily. Catch on fire? Dive into the water and retry.

The door at the end opens up into a ballroom with doberans and a pistol guy, although he'll be too busy dancing from Lara's barrage to return fire. The block nearest the lowest chandelier can be used to climb onto the expensive fixture, which then can be used to reach the 2F ledge with a switch -- this lowers a trapdoor behind the fireplace. Jump to the 2nd chandelier and the 2nd switch -- this shows a passage behind the Mona Lisa knockoff high up on the wall. From the 2nd chandelier, the 3rd (and highest) can be scaled to the lofty rafters area. Kill some rats and shimmy the middle support girder until Lara can pull up. (Save and) do a flatfoot jump to the wooden platform near the brick-laid corner of the room. Try to get up and a clubthug emerges, dropping a SMALL MEDIPACK upon death. The final switch is on the other side of the support girder and reverses the heights of the chandeliers, making getting down easier.

From the 3rd chandelier (now lowest), do a running jump-n'-grab to the painting's niche. Inside is a LIBRARY KEY! Now, return to the 1st switch's ledge and shoot the window. The ledge there shows the exposed back of the chimney, from which Lara can safely enter the pool of water behind the fireplace (rather than jumping through the fire -- dumb idea!). This tunnel leads to a dry spot with a keyhole begging for that new item we just got. Before that, there's a secret to get [2/3]! The watery passage before the door has a lever that opens into the adjacent one. Swim into the sunken corner to find the equally-flooded basement, with two pairs of GRENADE ROUNDS to snatch up and a GOLD DRAGON nearby. The switch right by the artifact will open a surfacing point right above near the fireplace.

LIBRARY & BOATHOUSE

Anyway, back to the library room that should be opened with the Library Key. A clubthug appears almost immediately but should be easy pickins from so far away. The room he emerged from has shelves that can be used as ladders, and by the rat squeaks we know something's up there. Climb up there, kill the vermin and pull the switch to open a door in the main hall. A gunman will have emerged so eliminate quickly. The library room he was in has tall shelves, and they can be climbed to the very top where a breakable window is found. Slide down the awning backwards, then backflip onto the balcony, then jump to the wooden awning below. Make it to the wall from there that overlooks the boathouse. Before jumping there, it's possible to jump onto the boathouse roof from that brick wall. Near the corner, jump over the next brick wall and find an UZI!

The man inside has AUTO PISTOL AMMO and a DETONATOR KEY on the table. Jump back in the canal and surface near the small wooden door, which will be opened by another gunman at that time -- he drops a LARGE MEDIPACK. Back in the main room of the library, the other double door has a lever to operate. Enter the room and be prepared to kill two gunmen who blow in through the window. They drop UZI CLIPS and SHOTGUN SHELLS.

The wooden side door leads out into a canal again. Check the nearest corner for a rat, and pull up onto the brick ledging to find a detonator. Ignore it for now and climb onto the higher brick wall that is parallel with the canal here. Storm into the room via the window to find the third secret [3/], the Jade Dragon, plus four packs of SHOTGUN SHELLS if that completes a trifecta.

To end this level, first use the Detonator Key on the detonator -- the small plunger box you usually see in Roadrunner cartoons. This blows up the house with the Jade Dragon in it, leaving behind a gaping hole in the exterior and entrance inside. A sniper will open fire immediately after the event, so dive into the water to evade most of his shots. The destroyed house is basically a small climbing course now to the top floor, the 3F room which now has roof

access. From there, simply follow the brick path around the corner and to a dark ramp. Level...EXIT!

04) OPERA HOUSE

[WK04]

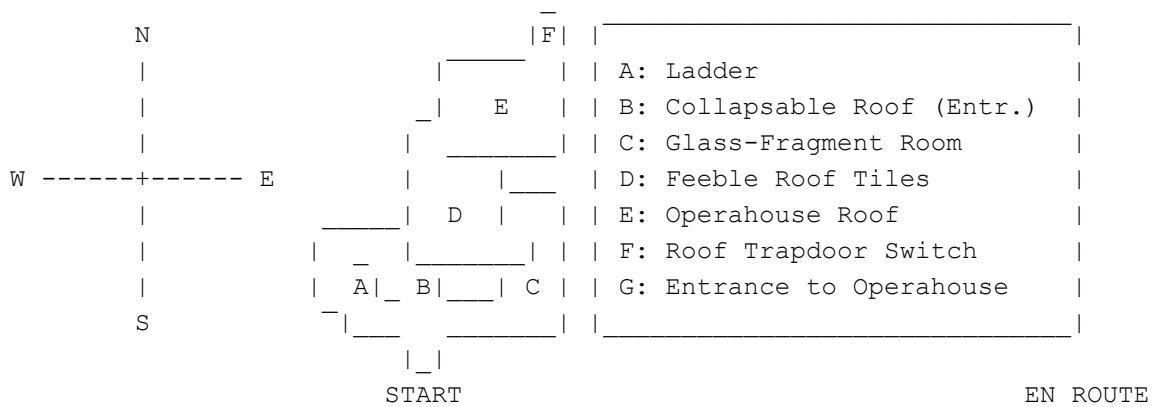

Our gal starts on a ledge high above the canal, near a crate swinging from a rope (this can damage her so avoid). Directly below will be a guard walking the beat. I suggest jumping to the ledge along the wall nearby and sniping him, then diving below and getting his AUTO PISTOL AMMO. One end of the canal leads to a ladder and a pull-up spot by a switch -- this will collapse part of a trapdoor roof nearby. Climb the ladder to its highest point, jump over the canal to the white platform, jump back to the starting platform, and from there, do a running jump back over the canal to land in the newly-opened roof portion. Whew!

There's a clubthug inside near an ORNATE KEY, and a second that comes from the door atop the stair (he drops a SMALL MEDIPACK). The path here leads back to the ladder/switch area. Return to the starting platform like before and jump to the flat roof space against the wall (where I suggested you snipe the patrolman below before). There is another flat roof ledge diagonal and below, so jump or slide down to it. Using the camera, jumping over the roof leads right to glass fragments, a.k.a. makeshift spikes. To bust in safely, use the long sloped roof, catch the ledge, the drop down to the breakable window. Glass spikes don't hurt if Lara slowly walks through, mind you. Take the ladder up to an alcove where the Ornate Key can be used; this leads to another ladder.

This leads to "D" on the map, some rafters with feeble roof tiles that will collapse when stood on. Naturally Lara falls to her death if a misstep is taken, but by looking at the course, it's possible to get across in two running jumps. The climable path in one corner leads to an outlook point. Snipe the first gunman, then hang down from that ledge to trigger a clubthug and two dobermans who can also meet the same fate without injury. One guy's dropped AUTO PISTOL AMMO and the other a LARGE MEDIPACK. There's are two more gunmen on the roof's opposite side but have to be dealt with close-up; one has SHOTGUN SHELLS, the other a SMALL MEDIPACK. Quite a haul!

There are three paths here: two are in corner alcoves, a third is near a corner but has glass shards that prevent immediate access. First let's hit up the alcove with a swinging crate. The jump is precipitous but the concept is simple: align Lara with the box' path, do a running jump, and turn toward the safe part of the ledge in midair. Damage can be avoided entirely! In the dark corner, the button lowers part of a trapdoor on the roof, unleashing a clubthug and gunman. It's possible to conserve ammo here by using pistols, if

you really want. Collect the SHOTGUN SHELLS and FLARES from a corpse before dropping down into the operahouse.

THE OPERAHOUSE

The drop-down point leads to two switches, but the only working one opens a gate with a stair below. Jump down and find the switch in a nook, closing the upper booth's gate and simultaneously giving access to another. With that done, it might be wise to spring the boulder trap at the stairtop. To do so, simply go as far down the stairwell as possible to hear rolling SFX, then hug the wall with the button to avoid being squished. From there, climb back up the booth ladder and enter the new alcove (the gate is a makeshift ladder) overlooking the operahouse's seating.

To bait a gunman's spawn, hang from the edge and quickly pull up for sniping privileges; he drops a SMALL MEDIPACK. The door on the opposite side of the balcony opens when approached, unleashing another gunman and his faithful dog companion. The dog drops KIBBLE...just kidding. The 1st gunman appeared from a stairwell on one side, so go that way, burying two more dobermans in the meantime. There is a defunct elevator here but can't be used yet. There is a drop-down point near the guy who came out of the double-doors, which lowers onto the 3F of the operahouse.

...and like before, hanging from the ledge baits some enemies into spawning, being a gunman on 3F, and 2 dobermans and a clubthug on the ground floor. I managed to kill all from 4F but not without some effort. The clugthug drops a LARGE MEDIPACK and the 3F gunman, 2x AUTO PISTOL AMMO. If you're wondering how to get to the second and third floors from the ground floor, there are various pieces of walkway that are used for the climbing course. It's simple so I'm not going to go in-depth on it. The 3F has a keyhole (can't use) and elevator shaft access, that contains rats, a gunman, and a doberman. They leave nothing but the dead-end path leads to a dressing room past a breakable window.

Here, a switch opens a slope to an air duct. The fan at the bottom will make mincemeat of Lara so jump at the last second and find another ORNATE KEY. To leave, climb up the brick platform until a gray slope leads into a fan-less duct. At the crossroads, there are deadly fans in every direction...but all is not as it seems! Do a running jump straight ahead, Lara hits the ceiling, and will stop before being sliced up. Do a standing jump from as far back as possible to clear the fan, then repeat it to reach the top. Turn around and jump to the dark passage above, finding the secret [1/3], a JADE DRAGON. A flatfoot jump gets back down, and the switch behind the movable block opens back into the dressing room.

To exit the dressing room, push the lower crate into the open space, then break a window and push the other on top of it. This has to be done in the middle, though, so the small wooden step on the floor can be used to scale it. A clubthug has appeared up, now, and if you like saving ammo like me, just shoot it with pistols, then drop onto the crates until it leaves. Back on the 3F balcony, use the Ornate Key to open a passage back to the stairwell near the upper booth. No need to go this way now, but later...

THE STAGE

NOTE: Watch out for ceiling sandbags. They kill Lara if they hit her!

Get down to 1F and a gunman will attack from the stage. There's another boulder boobytrap down here but it's easy to avoid if you know where it comes from (hint: dark, unenterable slanted door). He drops UZI CLIPS when

dead, and upon taking them, a doberman and gunman spawn. Exit stage right to a switch that opens a glass-spiked passage at stage left. Save and kill the two clubthugs congregatin' there first -- one drops a LARGE MEDIPACK -- then pull up into the glassy walkway. Once up there, do a standing jump to the wall crack, shimmying to the alcove with a switch, lowering a plank back on the main walkway. After a few jumps, the brick wall has an alcove that lets Lara reach the tip-top platforms with swinging sandbags. Timed jumping will get across to the next switch which opens a trapdoor on the stage proper. Slide down and jump as the last second to fall right into the pit!

...filled with water, natch. Light a flare and start exploring the passage behind where Lara dropped in. There will be a small duct that leads to the next secret [2/3], a SILVER DRAGON. Near this duct's entrance is waist-deep water by a switch, which opens a door on F3 of the opera seats. Return to the stage entry point and go the opposite way, surfacing near the exit ladder w/ a RELAY BOX at its feet; this is used to power the elevator. Remember where it is? It's on the top (4F) floor in that small side-stairway! Place the box in the slot to lower the elevator, revealing a ladder upwards...climb it!

This should be near the roof with the last secret [3/3], the GOLD DRAGON, right in front of Lara in some glass shards. Walk to it and obtain 4x UZI CLIPS, plus UZIS if you didn't get them before. The switch in an alcove opens a 4F door, while more UZI CLIPS are near the exit. Return to the elevator and call it back up with the switch, then press the switch again and hop in. Be ready to kill two thugs at the very bottom, both leaving SHOTGUN SHELLS. Pull the switch to raise the elevator, then hop in the flooded underside for a swim. There is a CIRCUIT BOARD to collect here, which can be obtained by taking a bunch of lefts when the path presents itself. When obtained, swim back to the elevator area and pull the lever underneath the other shaft, opening a door and letting Lara climb back to 3F (as we've done before).

The circuit board is used in the booth on 5F, so we'll have to go back to it. Use the Ornate Key on the 3F door if not done already, and push the hallway switch to give access back to 5F. Place the circuit board, flip the lever, and raise the stage backdrop. A gunman appears down there now, but can be killed from afar (like usual); he drops SHOTGUN SHELLS. Upon entering the door the backdrop covered, two clubthugs and their mutt appear. Again, if you prefer to conserve ammo, flip into the pool and take them out with jumps from the shallows. One drops a SMALL MEDIPACK; the others, just gallons of blood! Mwahahaha...

BACKSTAGE

There's a ton of crates here, but only one moves; it's easy to tell which one because it's lighter-colored than the others. The path behind has a switch which will lower the backdrop again, giving access to the small hallway Lara can enter from the top of the boxes. The clubthug who appears onstage leaves nothing, so snipe him and take the higher walkway to a small chamber. There is an upper alcove that leads to a switch, opening a door near the swinging sandbag. To evade the moving menace, (save first and) jump to the slanted portion near the 'bag; if done right, Lara will slide down out of harm's way and can time her run through that way. [Ignore the clubthug below as he has nothing of interest.]

In the storage warehouse beyond, time a jump to the wall on the "right" which is stacked with a bunch of crates. There's a double-pistol-wieldin' henchman with some dogs down there, and he's HARD -- consider using uzis or a grenade to take him out. When his dogs are also dead, kill the cowardly henchman who hid the entire time. All in all, a king's treasury worth of items: a SMALL MEDIPACK, UZI CLIPS, and three packs of GRENADES. To get out of this hellhole,

climb the boxes and find the button on the wall near where Lara entered the room. Pressing it opens the exit door in one corner, although our gal will have to murder a final gunman (who has UZI CLIPS) before being able to get away scot-free!

Now, a brief reprieve from water levels...?

05) OFFSHORE RIG

[WK05]

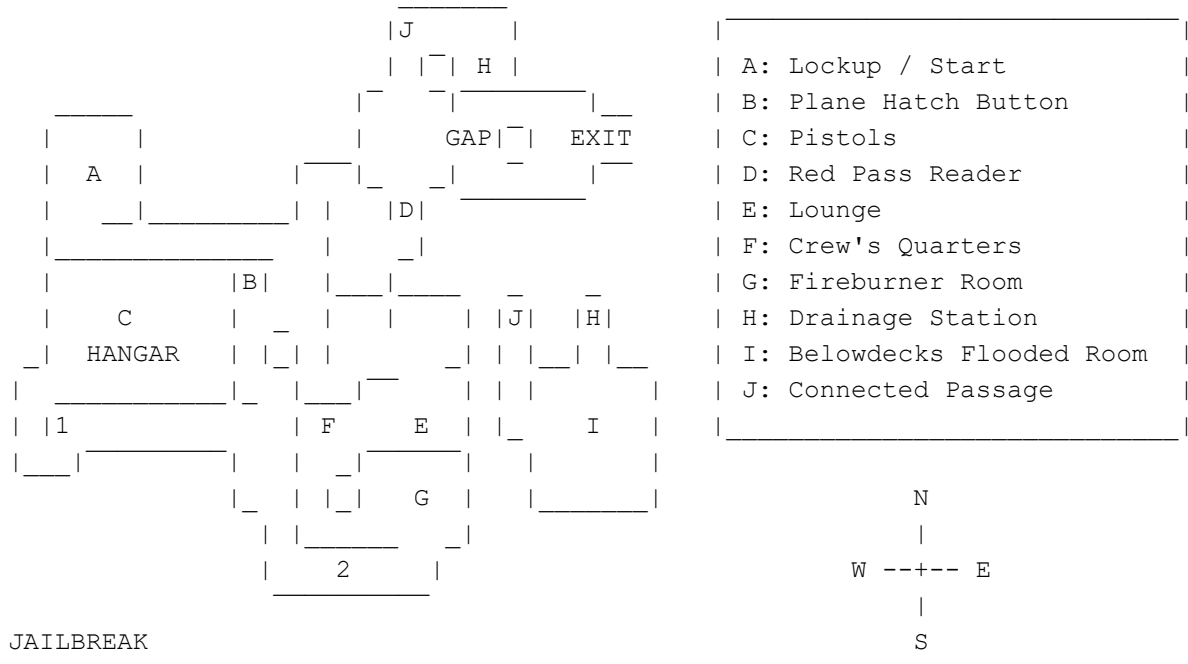

JAILBREAK

Lara starts the new set of levels in the clink, with her weapons confiscated and only her flares and ammunition remaining. To start the jailbreak, search behind for a pullable crate for a switch passage that opens the exit door. It's timed (about 8-9 seconds) so clear the way beforehand. Leaving the cell triggers an alarm and two armed thugs' attention. Evade the coppers by diving into the hangar and travelling to the other side of the seaplane. The underwater fan here has a large suction effect, so Lara must travel on the extreme left/right side to avoid it. Having said that, one side has a lever that opens a passage on the other, leading to a surfacing point. Search the pool here for another lever, opening a trapdoor in the previous passage -- this allows Lara to get the first secret [1/3], a JADE DRAGON, behind the fan. Surface in the hangar for oxygen, then return to the other surfacing point and use the passage to reach the hangar's upper walkway.

Going perpendicular to the seaplane, jump the gap near the security room's window and drop down to the other side, where a button opens the plane's cargo hatch. Inside, press the button to cut the engine. Backtrack to the hatch button's platform and do a running jump to catch the nearest wing, which is safe now that the propeller's off. On top of the body, run until a trapdoor sends Lara into the cargo room's other side, where some PISTOLS are.

With this, Lara can now fend for herself against the two brutes, a clubthug and gunman, in the hallway near the lockup. Surface there and kill both, collecting the LARGE MEDIPACK and YELLOW PASS CARD from their still-warm corpses. Watch out for the rolling barrel trap in that hallway; it triggers if Lara steps on the metal ramp. This corridor leads to the security room, and the double door can be opened by sliding the new card in its reader. A button beyond will shut off that dang alarm.

2 KEY CARDS

At the fork, take a "left" and kill the doberman/gunman atop the stair; one leaves UZI CLIPS. There's another barrel trap here, avoided by triggering it, then rolling to escape easier. The red-pass reader's here but unusable now. Backtrack, take the "right" stair to find a pressure-lock door that Lara can turn open. A clubthug appears from behind, so quickly eliminate him and get a SMALL MEDIPACK. Another thug appears in the adjacent room but is too far away to pose a threat, generally -- he leaves a LARGE MEDIPACK.

Unscrew the door to the lounge where a clubthug is waiting to play (leaves a LARGE MEDIPACK). Two packs of AUTO PISTOL AMMO are inside, plus four HARPOONS for a gun we don't have just yet. Luckily, the HARPOON GUN is right in the adjacent quarters, farthest bunk from the entrance! Explore around the room for more AUTO PISTOL AMMO and AUTOMATIC PISTOLS, plus a button that'll lower a (timed) ceiling trapdoor. Once pressed, scramble up to a high bunk and do a flatfoot jump into its upper alcove. Slide down backwards and catch the ladder at the bottom, else Lara plummets to a painless death. Down in "G" (Fire Room), there are two pushable blocks to take from their niche. It doesn't take a genius to figure out the solution -- once pulled out, jump off one and catch the ladder above the bunson-burner-esque fires.

Once pulled up, a stairway is beyond -- kill the clubthug as he approaches and steal the RED PASS CARD. The next ladder leads up into the sunshiney outdoors, where a SILVER DRAGON secret [2/3] can be plucked before going back down. The passage'll drop Lara back in the surfacing point near the hangar. Return to the bifurcation past the security station and go "left" this time, to the red keycard's door. [There will be a doberman and gunman, plus a barrel boobytrap, if you didn't spring/kill them before.]

Beyond, there's one gunman and two clubthugs who will attack Lara. Since she can get the drop on them, the easiest way is to kill the gunman and jump to his platform, then snipe the other two as they laze around. Spoils are SHOTGUN SHELLS, FLARES, and a SMALL MEDIPACK. There is a huge gap on one side of the room that can't be cleared now, so the exit will involve that movable block. Push it from one direction, pull it from the other, then push it again to put it on the edge of the catwalk. Do a running jump to it, then flatfoot jump into the upper alcove -- voila!

A shotgunner will be in the far passag beyond, so start taking potshots 'fore he notices...he drops SHOTGUN SHELLS, expectedly. The lever in this drainage room will drain one gigantic pit to fill the other. Pull it, do a softdrop down from the high alcove, and cross the newly-filled pit. Near the machine in-between the two, one side has two gray slopes against the wall. There's a switch here that opens the trapdoor in the drainage station. Return back there and take the slide downwards.

BELOWDECKS & EXIT

Lara lands on a high catwalk over a massive room filled with water -- the guts of the oilrig, to wit. Although not immediately visible, there are two (2) scubadivers swimming below. Snipe as many as possible and explore the catwalks, which are either long or small enough to require flatfoot jumps, killing the thugs up there. Spoils: SHOTGUN, SHOTGUN SHELLS. The walkways allow Lara to go around the room in one direction, so take that way. Near a shotgun guy is a windowed alcove that contains a GREEN PASS CARD. Right by that alcove's is a support pillar with the final secret [3/3], a GOLD DRAGON, at its base -- this is easily visible. If all scubadorks were murdered, jump into the water and get it, killing the clubthug who approaches. The reward for

collecting all secrets is UZIS and two UZI CLIPS. When the room is clear, find the ladder in one corner to get back on the catwalks. There's a climbable alcove on one side of the room, two platforms away from the green keycard's niche. Climb up into it.

The ladder at the end will drop Lara through a ceiling near the drainage station, although a clubthug has setup shop now. Kill him quickly for a SMALL MEDIPACK, then use the Green Pass Card on the reader to open the door here. Pull the drainage lever to switch the filled pool formation back to normal, then exit through the flooded alcove therein. At the end, pull the switch to a surfacing point and put this level in the books, yo.

06) DIVING AREA

[WK06]

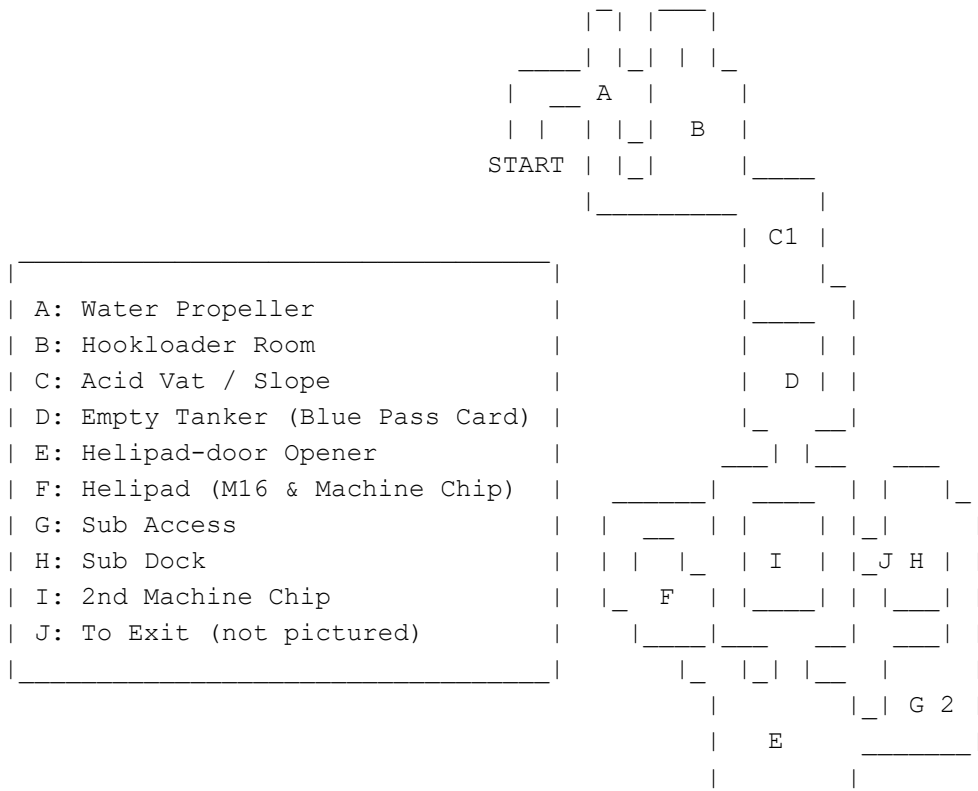

Up the first landing, there will be a room below filled with water...and a gigantic fan that will suction Lara and blend her like Colombian brew. To avoid such a fate, do a running jump to the ladder opposite the alcove where the fan's "off" switch can be triggered. The underwater switch will open the locked door nearby, but don't forget to get the two packs of GRENADE ROUNDS behind the fan first!

The room beyond has a automated hook loading system going on, plus a gaggle of goofballs to kill: two gunmen and a doberman nearby, two others on the far side who usually retreat to a far room anyway. For now, collect SHOTGUN SHELLS and 2x UZI CLIPS from the men. The nearest stairway leads to a surface point if Lara falls in the water, so the object is to cross to the other side. The hooks will travel over the platforms, and damage Lara if they hit her. The easiest way to get over is jumping the railing to the "left" of the two platforms, catching its edge when the hook is on the opposite side. Pull up on the side of the hook's path and then jump to the other side with nary a scratch. The two morons there drop FLARES and a SMALL MEDIPACK.

Beyond, a wide slope leads to a vat of acid at the bottom. Spot an aperture in the flat surface and slide to it, for the SILVER DRAGON [1/3]. Following,

Lara must slide down the rest of the way and jump to the platform normally (catching ledge doesn't work for some reason...fumes?). The jump can be a bit hard but eventually Lara'll make it, and can travel to the ladder in the next room. Atop the huge shaft, find a vacant room with a hole -- AUTO PISTOL AMMO and 2x M16 AMMO are inside. The floor hole has a ramp! Slide down backwards and catch the ledge, then drop to the catwalk the gunman is walking on and kill him for 2x AUTO PISTOL AMMO. Find the hole in the railing here and jump to the obvious alcove with the BLUE PASS CARD inside. From there, slide down and enter the only corridor at the tanker's bottom, then take the passage back to the lengthy ladder; from there, repeat the ramp bit again and use the blue card on the gunman's walkway to exit. Whew!

The hallway beyond is square, containing a bunch of dogs and one guy with a flamethrower. They'll try for a pincer attack on Lara, so the best way is to go "right" at the fork to trigger the event, then kill all the dogs before the flamethrower-man comes in from the left. It's simpler than it sounds. Of the two openable (crankvalve) doors here, one leads downstairs, one up; take the former. A clubthug appears at the lower landing, that contains a bunch of movable blocks, a circular saw suspended on a hook, and a locked room with two visible baddies inside.

This next part can cut it close in terms of oxygen use: the pool has a small entrance that leads to a series of levers. The only problem is a scubadiver will be pestering Lara, so it's prudent to take him out first with a harpoon gun. Anyway, the first lever opens a door that leads to another lever that opens a helipad door, accessible from the other crankvalve door in the square room. Surface and go there now, saving before entering. The copter takes off but two gunners and a clubthug remain. Collect the LARGE MEDIPACK, AUTO PISTOL AMMO, and SHOTGUN SHELLS from the bloody bodies.

The passage on the other side of the helipad contains some burners, a button, and a switch. Use the switch first to shut off the nearest burner and proceed to the hallway's trapdoor, leading to an M16! Return to the buttons and wait for the trap to reset, then press both switch & button (in that order), stealing the MACHINE CHIP at the dead end. Now, back to the previous room w/ a pool.

Behind the lone pushable block is a broken circuit board, but Lara's medical skills work excellently: place the Machine Chip there to open the nearest door! There's a clubthug and flamethrower-man inside, but both can be dispatched easily (conserve ammo w/ pistols?) for a SMALL MEDIPACK, plus there are 2x HARPOONS near the pool. One of the white consoles here is really a hidden door that swings open when Lara nears, leading to a button that will open a pool grate. Inside is the JADE DRAGON [2/3]! The other circular hole leads to an adjacent room, but two scubadivers will be hot on Lara's trail! Stay unpredictable to avoid the harpoons and look to a pull-up spot on the "right" upon entering; kill the scubadivers when they approach, then the two clubthugs around the rimmed walkway. A button is behind that pull-up spot, and opens a door way back in the room we put the Machine Chip in. Watch out for a 3rd scubadiver who comes in before heading back.

The two thugs from the previously-locked room attack when Lara surfaces, and drop a SMALL MEDIPACK and UZI CLIPS. There's a switch inside the newly-opened room that will move the circular-saw-on-a-hook closer to the opposite side of the pool. A mechanical saw prevents access to a keycard, so instead, jump behind the two crates to find a spooky secret entrance! OooOoooOo! The button within raises a duct on the helipad, so it's back to there now. En route, kill the shotgunner (SHOTGUN SHELLS) and some dobermans and a shotgunner in the helipad stairwell (UZI CLIPS).

The helipad has risen upwards and now the central duct/pillar reveals a room below. Fall into the room at passage's end and kill the flamethrower-er and thug (they don't attack all at once, luckily) for a final MACHINE CHIP. Go back to the room with the circular saw, put the second Machine Chip into the wall slot, then take the RED PASS CARD without fear of being de-handed. Now, go back to the central room where the 2nd Machine Chip was found and use the new keycard to enter the special-access door. [NOTE: Whichever door Lara exited before will be opened; the others are still closed.] Save?

Behind the red door is a lower hallway where a shotgunner waits; past him, another drop-down point that leads to the submarine dock. The two guys here should have been killed earlier, so Lara can rob 'em for a LARGE MEDIPACK & SMALL MEDIPACK, plus two packs of HARPOONS in a corner. Down the sloped corridor, enter the watery pit near a locked door. Follow the passage -- in which Lara overhears an interrogation above -- and surface near a room with two guards and a beaten person. Enter the room below for the GOLD DRAGON [3/3], plus 4x UZI CLIPS if that's the final one.

To end the level, approach the beaten monk.

07) 40 FATHOMS

[WK07]

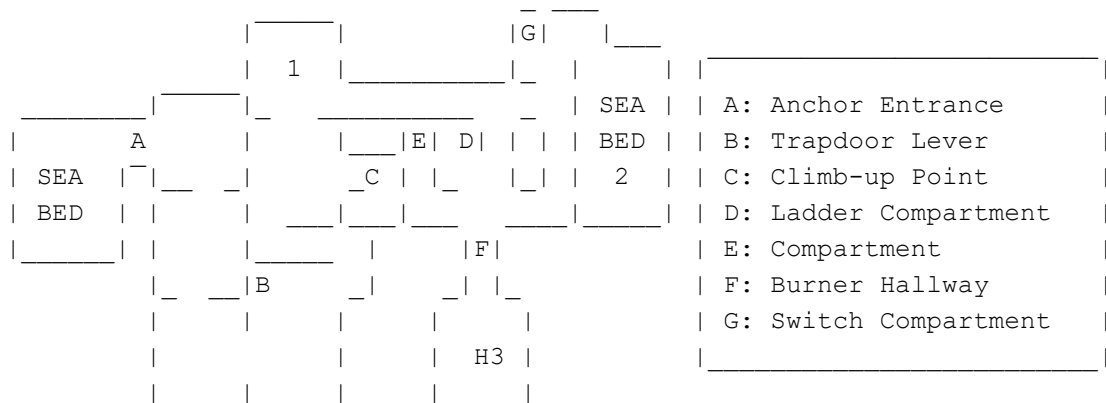

SHARKBAIT

After the scene, the bathysphere/submarine will have been trashed and Lara will be stranded forty fathoms underwater! What's worse is a great white has spotted Lara and is in the mood to snack. When control is switched to the player, immediately "roll" and start swimming in the opposite direction. The rusty-metal scrapheap alongside the wall is a sunken ship. Look for a its anchor near the cliffs' corner and swim down into the hull beyond.

The sharks will still be in pursuit however, so continuing swimming through the adjacent compartments of the hull: there's three more in all. In the third, there is a locked trapdoor on the floor, and in one corner, a lever that will pop it open. This leads to a room with a bunch of floating crates, and in-between a huge stack, an opening leading to solid ground at last! The switch in the corridor drains the crate room, and from there, Lara can do the small climbing course to the upper passage unavailable before.

BELOWDECKS

From the ledge, the SILVER DRAGON [1/3] should be visible below. Hang from the ledge to bait the shotgunner's spawn, then snipe him from above without taking (much) damage -- he leaves SHOTGUN SHELLS. There's a trapdoor in the middle of the room so avoid it while taking the artifact. If Lara can trigger

the central trapdoor, she can probably snipe the two thugs walking the room below as well. They'll leave a SMALL MEDIPACK and HARPOONS, although if any die on a slanted slope, it can't be picked up. There's a passage with flickering light on one side of the room, and by jumping to the nearest flat pillar, it's accessible.

The flickering corridor has pipes across the floor, making quick running a challenge. At the very start of the passage is a lever, opening a door at point "D" -- it's on a timer, so do running jumps over the pipes in order to maintain momentum. The passage beyond leads to the seabed outside the ship, where a shark and some barracudas patrol near a JADE DRAGON [2/3] sitting on the cavern floor.

Back inside, Lara will have to do a multi-segment timed run, and since there aren't enemies inside, familiarize yourself with the corridors and places of interest: burners, a ladder in a passage, a dead-end passage with a closed compartment. There's a small bit of untimed preamble first though:

- 1) Atop the ladder ("D") is a switch that opens a compartment ("E")
- 2) Run to "E" and flip that switch, shutting off a burner at ("F")

Now the timed portion begins!

- 3) Run to the burners ("F") and flip the switch, opening a compartment ("G")
- 4) Run to ("G"), flip the switch, shutting off the other pair of burners ("F")
- 5) Run back to ("E") to shut off the other burners again
- 6) Quickly run to the burner hallway ("F") and shut off the other switch now

That's it! If you're having trouble even though you know what must be done, it's probably the route taken to the switches that loses precious time. When the burners' door is opened, SAVE! There's a small pool with a barracuda in it beyond, so jump in to draw it out then pump it full of hot lead.

For the next part, jump in the pool and start swimming to the very top of the shaft with a bunch of holes. There's a lever up there that opens a door at the very bottom. Swim back down and flip that lever, then collect the GOLD DRAGON [3/3] and 4x HARPOONS before dashing all the way back up to the door opened. Three barracudas will have been unleashed there but can be ignored; go straight for the surfacing point!

TO THE EXIT

The passage up there leads back down to a room full of rusty detritus. Locate a hole in the floor around the central structure, then drop down into a 2nd room of similar cleanliness. A movable crate here will give access to an upper alcove, whose switch dumps dirt from the upper compartment. With the layout changed, there are now 3 exits: two on one side of the room, one opposite.

Take the pair on the left side first. They open a door and flood a huge room somewhere, respectively. Return to the room with the pushable crate and take the rust-colored alcove opposite, twisting and turning to the huge shaft that is now filled with water. There'll be an annoying scubadiver when Lara tries to swim down the horizontal passage, and after surfacing, 2 shotgunners will try to blow off her head. They leave SHOTGUN SHELLS and a LARGE MEDIPACK, but take the 2x HARPOONS sitting here as well. Push the switch and exit...whew!

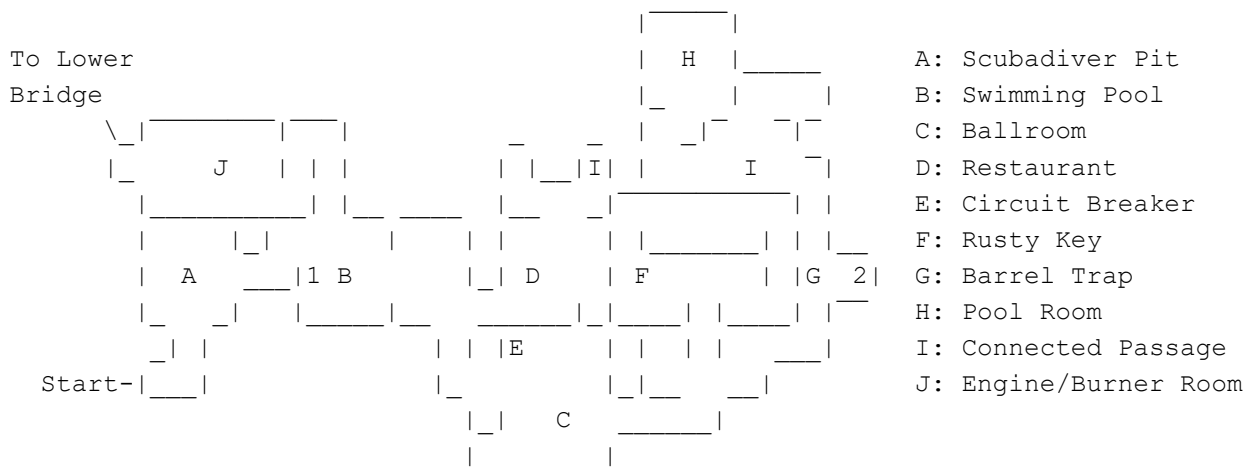

PRE-BALLROOM

From the initial hallway, there's a pool just beyond with a scubadiver; jump in and climb out to bait his appearance. Two packs of HARPOONS lie on the tanker's bottom. The only sunken passage leads to a pull-up point near a LARGE MEDIPACK. Save before sliding down to the breakable tiles underneath the ramp, which will drop Lara through the ship's old swimming pool, and not without some damage. A clubthug and gunman will saunter up from the doorway nearby so plug 'em for AUTO PISTOL AMMO and 2x SMALL MEDIPACKs. There's also a SMALL MEDIPACK in the water nearby, so get that as well. Through that doorway, look behind some broken furniture for a ceiling hole with a shotgun thug therein. Drop through the hole on the other side to land in a pool changing room, containing the SILVER DRAGON [1/3]. Return to the furniture room now, past the shotgun guy who takes potshots from the ceiling vent.

One corner has a few movable blocks, uncovering two passages: a restaurant with a locked bathroom and a passage leading to a ballroom. Go down the latter first. Upon dropping into the passage, three thugs will encroach from level ground and where Lara came from, dropping a LARGE MEDIPACK and FLARES. In the ballroom, one passage will lead to some glassy spikes near a pit. Carefully walk through, drop-n'-hang in the rim, then catch the ledge below that leads to a REST ROOM KEY. A flatfoot jump out of the alcove can get back upwards. Kill the shotgunner on the balcony (actually the balcony's underside) here if not done already.

Return to the restroom and find the locked small door with a keyhole behind some broken furniture. This gives access to the small button beyond, opening the double doors behind and unleashing a clubthug! Push this 2nd button to unlock a door on the ballroom balcony. Make sure to hit the 1st button again to close the doors, as it resets access to the hallway there. Now, back to the ballroom...

BALLROOM & VICINITY

So, the task is getting on the balcony. The corner opposite the passage that had the Rest Room Key has a small ramp Lara can stand on and climb up with. Hanging from the balcony ledge, shimmy past the opened door and to the dead shotgunner who's dropped AUTO PISTOL AMMO. From the rest of the balcony, Lara can jump a gap (with glass shards at bottom) and catch a platform with the first CIRCUIT BREAKER on it. We'll need this so don't leave it! Return to the opened door and climb in.

This next hallway has five doors, two pairs and one at the far end. The first door with a crankvalve is empty, so take the only other one available and softdrop inside. Push the off-colored movable crate underneath the wall

switch, opening the compartment door above. The 2nd off-colored crate will give access. Follow the corridor until a clubthug (well, wrenchthug) climbs up for the kill. The room he came out of has a single movable crate hiding a RUSTY KEY. A wall switch opens back to the 5-door hallway where the key can be put to use.

Softdrop down to a room with more movable crates. The higher of the two has to be pulled out, so align the lower one with the ledge to do so. Push the third block to find a lower corridor beyond. It has four breakable tiles that hide burners, and as soon as Lara crosses them, be prepared to jump over the barrel trap that tries to railroad our gal perpendicularly. The ceiling hole they rolled out of contains the JADE DRAGON [2/3], but there's a second barrel trap to spring (read: pull up, fall down, sideflip) before snatching the sucker. At the other end of the lower passage is a shotgunner who should be easy pickins with the jump-n'-shoot strategy.

The hole the shotgunner patrolled by has a floating boat below. There's a sunken lever that opens a compartment door high above, but it's on a timer (this one actually gives leeway for mistakes!). Pull the lever therein and approach the second door, which will close behind Lara. At the slope's end is a trapdoor, so slide down backwards and catch the ledge to harmlessly bypass its effect. Jump up to the 3rd alcove's switch and a blue door will swing open elsewhere. Return to the mesh walkway above the boat and pull up into the corridor opposite the barrel hallway's entrance.

This leads to a multi-tier room above a shard-filled pool, with three gunmen sprinting around. Lara should be able to pick a few off from the opening walkway, and with the pistols no less. There are buttons on each tier that will lower a timed platform of trapdoor, providing opportunities to descend. All in all, a 2nd CIRCUIT BREAKER is available, plus a SMALL MEDIPACK from one of the corpses. The lowest button drains the boat room before. To leave, notice how the carpet near the circuit breaker triggers an audible 'thud' nearby? That's the sound of a trapdoor dropping across the pool. Run there and pull up before it collapses.

Back in the boat room, softdrop down (Lara takes damage) and use the crank door to find a ventilation duct. Ignore the darker offshoot and drop down to the passage near the restroom where the 3rd and final CIRCUIT BREAKER is now obtained. [NOTE: If the doors impede Lara's movement, she'll have to go all the way back around and close them. Sorry, but that's why I reminded you to do it previously!] The new button here opens a trapdoor in the darker part of the ventilation duct's offshoot -- go there now. Get the drop on the two goons near the restroom. They drop UZI CLIPS and 2x HARPOONS...first drops in awhile!

THE CIRCUIT BREAKERS THREE

The whole level was spent collecting these dang things so let's put 'em to good use. Return to the upside-down pool near the start of this level and find the water-filled passage in the corner. Get the SMALL MEDIPACK if not done previously then swim until a huge upward-leading shaft is found. There is a wall lever in there that opens the surfacing point's trapdoor above. Immediately following, some thugs will be seen, guns blazing, in the chamber adjacent -- they drop a LARGE MEDIPACK, UZI CLIPS, and 2x SHOTGUN SHELLS.

Now for the fun puzzle-solving part. This upside-down engine room has burners that can be deactivated, one for each Circuit Breaker. This gives access to a pushable crate that can get to the higher alcove where a wrench-swinger is hiding near a switch (pull it!). From that position, do running jump-n'-grabs across the engines' topsides until reaching the blueish passage opposite the

entrance. The long shaft should be flooded now due to the switch...

After a cool plunge, follow the passage onward, keeping an eye out for any barracudas around (creepy music plays here). The two exits lead to 2x HARPOONS and the other has a wrenchthug who drops a SMALL MEDIPACK. The large area on one side -- that with the great view through the window -- is the ship bridge. Before doing anything else, explore around a bit and find 2x AUTO PISTOL AMMO nearby. When ready, open the bridge's crankvalve door to find a lever that opens the door opposite there, which contains FLARES and a movable block. Behind it is a switch that opens a trapdoor above water in a dark portion of the bridge -- find it! Save before jumping in!

This leads to the ship's underside where great white sharks and barracudas roam the open sea range. Y'may have noticed a key visible from the bridge's outlook, and that's the cause of this fishing expedition. To find it, swim parallel to the ship until the cavern expands, then go "right" toward the bridge window. Look on a lower escarpment within window sight to find the CABIN KEY! There's also one more reason to come here -- the GOLD DRAGON [3/3]! It's in a cave opposite the trapdoor's opening, in a high-up surfacing point. The reward for finding all secrets is a GRENADE LAUNCHER and 2x GRENADES. Get back inside the shipwreck when done.

EXITING

Back on the bridge, use the Cabin Key and find a switch that lowers a tile so Lara can push the block in the rectangular groove below a 2nd switch. This one opens a trapdoor above the captain's cabin we just opened. This'll deposit Lara into the multi-tier glass shard room ("H") which now has water in some tiles instead of spikes. Two thugs patrol the lower echelon walkway and two scubadivers further down. Kill 'em all and collect the bounty they carried: SMALL MEDIPACK and M16 CLIPS. There's also 3x M16 CLIPS in one of the dark dead-ends.

Once the hazardous waters are slightly less so, dive in and scour the seabed for some old oil drums; behind them is a cavern with some lamprey eels and barracudas. Don't bother with harpooning them; just swim along, taking the twists and turns until spying a metal structure's entrance. Approach and the level ends...whew! I can't wait 'til the water levels end...

09) LIVING QUARTERS

[WK09]

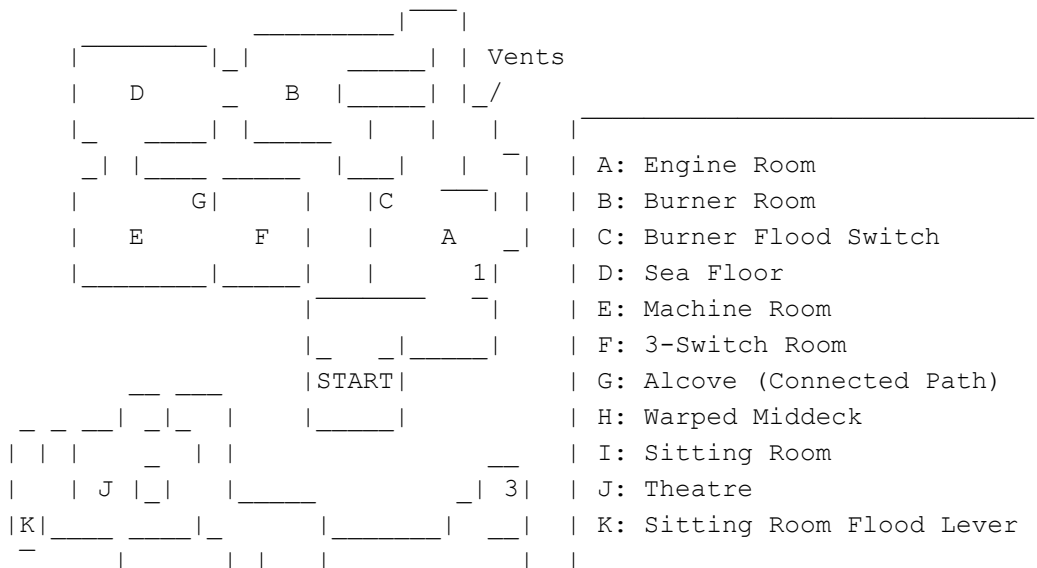

```

| I _ _ | H | _ | | |
| _ _ | | _ | _ |
| | | _ _ | _ | 2 |
EXIT | _ |
      |G|
      -

```

As with the end of last level, the start has Lara in an underwater cavern. Swim through the large metal opening and turn around left, looking for the wall lever that opens a trapdoor at the far end of the structure. Up inside the hull, a clubthug will emerge from the only doorway, dropping a SMALL MEDIPACK all the while. This leads to the engine room ("A") with a bunch of piston platforms above -- we'll use those later. For now, climb over the machine at one end and take the only lower passage there until a small drop-down point. Two armed thugs approach here, leaving HARPOONS and AUTO PISTOL AMMO.

Around the corner is a burner room with a barrel trap headed straight for Lara. The best option is to jump over them, although rolling and retreating could work too. The wrenchthug within leaves nothing. Notice the long pipe groove that runs parallel with most of the burners? Do a running jump and catch that, shimmying to a switch that deactivates the burners. There's a ledge above that will lead to a rusty passage containing another switch, this one moving the engine-room pistons' position. Lara should now be able to move across the pistons (flatfoot jumps) to the end, and do a running jump to the SILVER DRAGON [1/3] sitting in plain sight on a side niche.

Jump back to the high passage at the end of the pistons and kill the shotgun thug within (leaves AUTO PISTOL AMMO). Beyond, there are two packs of SHOTGUN SHELLS sitting in a corner near a single pushable crate. Move it out of the way first, then drop into the room below -- it's the piston-control switch area. Press it to reset the mechanisms' positions then climb back up into the vent with the movable block. Return to the engine room and hop across the pistons, this time finding access to an alcove switch -- this floods Room B, where the burners are. Get down there in your preferred manner (the pistons have reverted to the "on" switch position).

In the burner room, now completely underwater, flip the wall switch and exit through the back door to the seabed. There's a scubadiver here and a surface point for air, plus a locked trapdoor. To open the trapdoor, there's a cave with a black lamprey (kinda like the eel from Super Mario 64) by the switch, although this one can easily kill Lara -- stay away! Said trapdoor leads to "E", the machine room, with a shotgunner patrolling the ventilation ducts. He drops nothing but there's a block near him that needs to be pulled out later.

MID DECK & SITTING AREAS

The main goal is to get on top of the exposed ducts, and there is an easy and hard way to do this:

HARD WAY: Flip the switch in the machine room to open the door opposite, which leads to dead-end room with two switches side-by-side. These temporarily raise two metal flaps that Lara can jump-n'-catch, then shimmy to another switch. This lowers a grate back in the machine room. Return there to the corner of the room and find some angled ledges underneath. Jump forward the lowest, backflip to the middle, then jump forward and catch the high ledge. This gives position to get onto the vents.

EASY WAY: From the machine room, face the door switch. To the left and right

are lower, horizontal 'squiggle' ducts. The right way is quickest and gives access to the an alcove in the far upper corner.

Whatever path to the ducts is taken, the object is to jump to the alcove in the upper corner. The easy path skips nothing important so just do that, eh? Through the dead-silent middeck, there'll be a wrench thug coming from a corridor that leads to the GOLD DRAGON [2/3]. The problem is it's right by a hunk of glass shards. To reach it, face the dragon from the upper passage, put Lara's back to the wall, and do a flatfoot jump towards the hole; in midair, hold action button to lower the jump arc and land safely past the spikes.

Back upstairs, the other path leads to twin slopes with feeble tiles in-between containing glass spikes. The pool past there has a barracuda, and contains a breakable tile with a 2nd barracuda inside. This also leads to the JADE DRAGON [3/3], plus 4x M16 CLIPS if that's the final artifact found. Back in the pool, continue to the warped middeck. Locate a breakable tile and get to the corner past it. See the slanted slope and the shimmy-able groove? Sideflip so Lara slides forward and can catch the groove, then shimmy until pulling-up is possible. There's only one way to go in the corner.

The parlor and sitting room have three shotgunners but they appear one at a time. When two are killed, find a pushable block that gets down to the lower dancefloor where a third can be killed (plus a wrenchthug from a nearby pit. That pit has a 3rd movable block with a THEATRE KEY underneath.

THE THEATRE

To find the theater, return to the 1st block pushed here; pull it out as far as possible, then go around to the passage again (jump railing near block #2) and find the passage beyond. There'll be a shotgunner to contend with during these events, mind you. Kill the wrenchthug nearby and unlock the double door to the theater, where a few more wrench goons await. Kill a shotgunner walking around the box seats (wrenchthug out of view) and flip the switch, pulling back the curtain onstage. Out of all the dead bodies made so far, only one drops UZI CLIPS...using pistols conserves ammo, remember!

Behind the curtain, pull the movable crate to get access backstage, where a glassy spikepit is near a wall button, which floods Room "I", the parlor & ballroom area. En route will be a single shotgunner (drops SHOTGUN SHELLS), but as soon as Lara crosses the pool and climbs up, the level ends. Whew!

10) THE DECK

[WK10]

To 4F

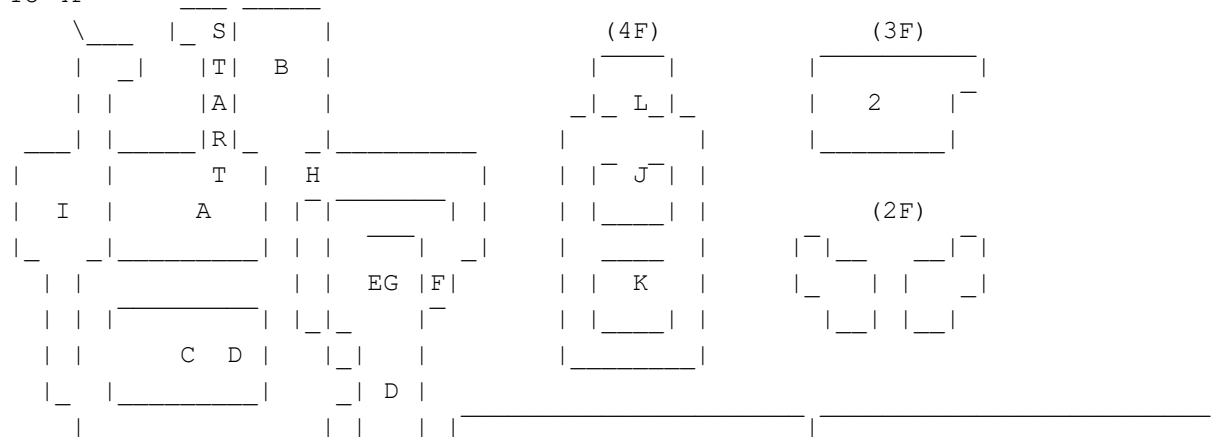

_____	A: F1 Deck	H: Passage to 4-2F Dcks
M N	B: Stern Key	I: Blue Cave Slope
_____	C: Stern Bldg	J: "K" Bldg Switch
	D: Passage to "E"	K: "L" Bldg Switch
	E: Raft Cavern	L: Storage Key
	F: Dropdown to Raft	M: Storage Shed
	G: Cabin Key	N: The Seraph
<u>LOWEST DECK (F1) & STERN</u>	_____	_____

At the start, exit onto the deck which has been wedged into a cavern and is completely dry. There's a flamethrower-er and a thug wandering about, so try to play nice. One drops a SMALL MEDIPACK but the flamethrower guy expectedly drops nothing. Look for 2x GRENADES around the corner then backtrack to the starting point, going the opposite direction. The broken windows overlook a pool with two barracudas below ("B"), plus a STERN KEY visible on the rocky crags. Jump down, find a climb-up point, and kill the fishies; then, do a small course to reach the key in question. The pool drains back to the deck cavern, this time at its lowest reaches. A wrenchthug and flamethrower-er are around, too, but drop nothing.

To find the stern, look around this lower area for a building with a rusty propeller and four boxes in close proximity on the opposite side. The door is actually obscured by the boxes, so do undo that (1) push the single box towards the middle stack (2) move the highest box onto the farthest box (3) pull the first box back (4) pull the middle box back. Voila! Collect FLARES and enter inside.

Within the stern pool, there is a wall lever near the ceiling just before the room with a sunken crate in a groove. This opens a trapdoor above a ladder near where the lower flamethrower-guy was murdered. The gunner who's replaced him leaves SHOTGUN SHELLS. Step onto the floor trapdoor, follow the passage below, and use the lever that drains the stern room. It's still as easy to get into, but make sure to softdrop down en route to the box. Pull it out

CAVERN BLOCKED BY PROPELLER

Lara may have seen a cave entrance blocked by a fallen propeller around the stern building. The passage she's in now leads there. An inflatable raft sits silently on the lake, but if Lara wants first-hand observations, she'll have to draw out the two scubadivers around. When they're dead, surface near some boxes and take out a wrenchthug by 2x UZI CLIPS. The SILVER DRAGON [1/3] is hiding amidst some seaweed on the seafloor.

When it's obtained, return to the ledge with boxes and start jumping toward the far corner -- it's easy as self-slicing pie. The path there winds around back to the lake where a shotgunner is (SHOTGUN SHELLS), a LARGE MEDIPACK and a drop-down point onto the raft. Lara will take damage when falling to the raft, so make it maximum before hand. Softdrop down to 2x HARPOONS and a CABIN KEY. Before jumping out willy-nilly, notice 2 great white sharks have appeared somehow -- give him a burial at sea.

To return to the upper decks, return back to the passage with the shotgunner and look for a small offshoot that leads to a climbing course. It's easy but takes awhile. At the end, it will give Lara position to get to the top deck.

TOP DECKS (2-4F)

A shotgunner and 3x wrenchthugs can appear on the 4F deck, but only one'll leave something useful: FLARES. The 3F deck we're on now is composed of three

locked buildings that we can't get in now. Locate the side of the deck that overlooks the 3F pool and see if the flamethrower-er guy is out and about; he should be if both wrenchthugs' spawns were triggered. Before dropping down make sure to get the 2x GRENADES in a pit against the rock wall, on the side opposite where Lara started.

Drop to the next-lowest deck with the pool (3F) and kill the flamethrower-er and pool barracuda if not done already. Jump in the pool and approach the shiny-tile corner to see a scubadiver emerge from the secret passage. Kill him and take the GOLD DRAGON [2/3] inside! There's 2x M16 CLIPS in a dryer corner by a movable block, too. This block will be the go-between if Lara needs to get back to the top deck quicker -- the easiest way is to move it two spaces 'south' so it's being pulled under the 4F eaves, and she'll be able to jump up and grab the gap in the railing. But anyway...

The 2F deck is split in two, on either side of the 3F deck. A shotgunner is on one side, nothing on the other. If Lara goes down there, she can push a crate around and use it as a go-between to get back onto 3F (for reference). Do not slide down to the lowest (1F) deck! Instead, from the 2F deck -- the side that didn't have the shotgunner on it -- locate the weird stack of rock and wood and jump to its flat top, then do the same to the metal building en route to the stern building. The camera angle should change here, and the JADE DRAGON [3/3] should be visible in a rockwall alcove. Through the glass, there's also 4x GRENADES if that completes the secret set.

|
| NOTE: If you get the Jade Dragon now, you'll have to go all the way back |
| around through the inflatable raft cavern and do the jumps again! Beware! |
|

From the metal structure on the end of the 1F deck, jump to the roof of the stern-key building. This jump has to be done from as close to the secret alcove as possible, mind you; Lara can't catch the edge! Once across, move to the side with the propeller, and jump backwards, doing a grab-n'-catch. Below is a crack Lara can catch, shimmying to a pull-up point. There's not much leeway here, but a running jump from there can reach a blueish opening in the rockwall.

4F DECK, PT. II

Follow this to the blue cave's slope ("I"), which is incredibly steep but has flat ledges that can be used as stepping stones. Two wrenchthugs will be up there so try not to kill any on the slope, or the LARGE MEDIPACK it drops may be lost. At the tunnel's end, Lara's back with 4F deck access. This time, though, jump onto the building's awning. The other building nearby has a roof trapdoor -- fall through.

Kill the wrenchthug and take 2x AUTO PISTOL AMMO, then pull out the crate near the exit to find a switch...this opens another 4F building's door. En route, a shotgunner drops 2x AUTO PISTOL AMMO, too. Inside this 2nd building, take 2x M16 CLIPS and use the Cabin Key to unlock the door. There's a button that opens the 3rd building's door, but it's route has fall-away tiles with glassy spikes below. Keep to one side of the room when going to the button, then take the remaining to get out scot-free. A wrenchthug intrudes on the way out, though.

In the third building ("L"), follow the stairs and cavern to the dead end. From the slightly raised stone, jump to a higher (and slightly lit-up) block, then even higher. This overhang has a hole that leads to the STORAGE KEY on the 3rd building's roof. The storage shed is on the ground floor near the

entrance to the stern-key building, just farther along. To get down there, descend the decks like before. You can either take the water way (where the Stern Key was before) or do the "jump to Stern Key building roof and slide off" strategy...either way, get to the ground floor.

| NOTE: Get the Jade Dragon secret now if you didn't already! |

There will be two flamethrower-ers down there. Locate the only door locked in that vicinity and find the THE SERAPH inside. Taking it ends the level... the water levels have finally ended! Yeehaw!

11) TIBETAN FOOTHILLS

[WK11]

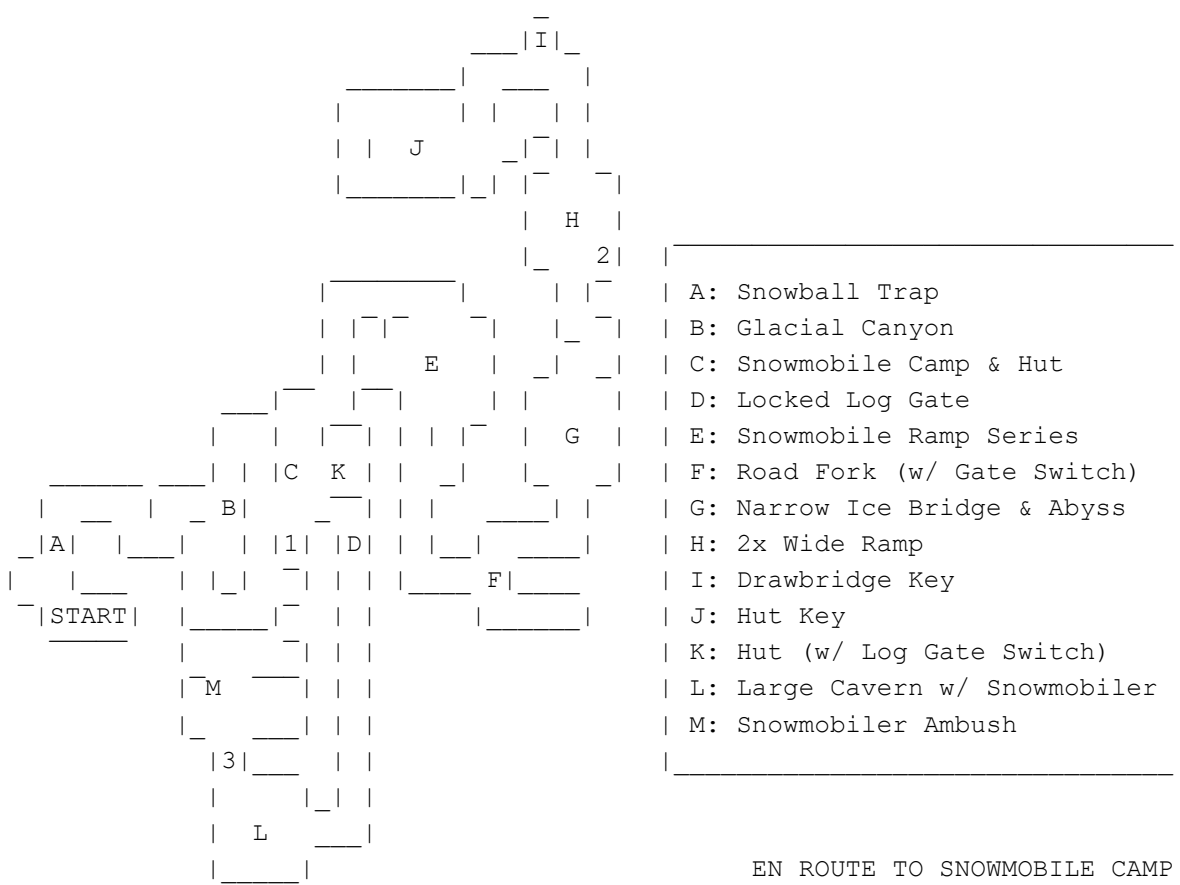

Right at the start, kill the condor and follow the path until Lara's at the foot of a slope. There are visible snowballs at the top, and they work like a boulder trap -- these have to be jumped over, generally. Just watch out for a second pair that follows the first. If Lara looks near where the snowballs landed, there's a see-through cavern mouth that can be shot open. A leopard's inside guarding 2x AUTO PISTOL AMMO.

The cavern the snowy boulders rolled out of has a 2nd icy see-through window that is immune to guns but can be jumped through. Just be sure to save first, because if Lara doesn't do it correctly, she slides into a gigantic pit!! Through the tunnel past the pit are two condors flying over a huge glacial canyon, with water at the bottom and a snowmobile camp on the other cliff. Do a softdrop down from there to a lower ledge, then catch the edge; below is a doorway that leads to the "long way". We're going to take the shorter way. Shimmy to the snowy ledge to the "right" (which is actually a ladder if Lara falls into the water), and locate the LARGE MEDIPACK across the way, at

the bottom of a slope. Do a running jump to it (slope) and be placed near the item with little to no damage. The fun part is climbing up the snowy chunks to the snowmobile camp instead of going all the way 'round.

At the camp are two uzimen who can be taken care of in Lara's preferred fashion, robbing 'em for a LARGE MEDIPACK and 2x AUTO PISTOL AMMO. The SILVER DRAGON [1/3] is in a corner near some light-colored rocks and a gate, which one may have spotted on the long way 'round. There are two tunnels here but one has a log gate, so take the other. [NOTE: The snowmobile isn't required to complete this level but it helps since it instantly kills baddies if they are run over.] Speaking of which, there's a guy to run over a little ways in the tunnel, dropping SHOTGUN SHELLS.

Along the way to "E", an expansive area with a meandering snowmobile ramp, there aren't any enemies in sight. Locate a small alcove next to a larger roadway and climb up to it (former), which triggers two snow leopards a sec later. The two movable blocks there can be pushed into the passage, clearing the road for snowmobile jump. When everything is in place, use the default ramp near the middle of the expanse to jump the longest series of ramps; follow alongside them until locating the next in the ramp chain that leads back around to the series. The controls are the same as the motorboat so use Forward + Action to use turbo boost. Save after each segment if needed, until Lara's vehicle skyrockets into the opening where the movable blocks once were. There's another huge gap requiring turbo-boosting beyond.

THROUGH THE CAVES

Further through the vacant caves, come to a larger cavern that has a fork with an abyss in the middle. The right way has 2x GRENADES and the switch up the ladder opens the gate on the left path. One can be shot across the abyss and the other can be ran over -- M16 CLIPS and a SMALL MEDIPACK overall. Ride the left, lower path here through the previously gated door. There'll be a narrow ice bridge across a giant pit, and two guys to run over as well. They don't drop anything, and neither does the guy inside the rocky cave at the other end.

Approach the outdoor ramp and look for the JADE DRAGON [2/3] on a ledge off to one side. This an easy jump, but triggers two snow leopards on the main road -- dangerous indeed! Turbo-boost over the snowy ramp, and once across, look for a glacial ladder on the left side. This lets Lara get down to the vacant bottom of the ravine, and once she picks up 2x GRENADES in a pit, this unleashes more 3x snow leopards.

Back up the ladder, go on foot into the next cave. Four snowballs are placed precipitously on the icy slope. Trigger the first avalanche by inching in a bit, then trigger any remaining ones by sliding backwards to the glacial ladder and climbing up for a moment before sliding down. Toward the bottom of the ladder is an opening with the DRAWBRIDGE KEY! The pit beyond contains a gunman behind bars, and a boobytrapped switch (icicles above) that leads Lara back to the outdoor ramp area. Climb back up and take the snowmobile past the snowball-less slope.

On the other side, ignore the switch in a corner (leads to a dead-end area overlooking snowball slope) and continue to the chamber where the Drawbridge Key can be used -- it lets Lara get to another ledge. There's an avalanche waiting to happen on the other side, but the snowmobile's turbo bypasses it easy 'nough. In the snow-filled cave beyond, an abyss lurks around halfway through, so use turbo again to clear it. Return once again to the avalanche room and find the HUT KEY at the base of the destruction. An enemy snowmobiler attacks at this time -- stay clear of his vehicle and kill 'im quick. Take

the default snowmobile (enemy's has machine guns instead of turbo -- lame).

The Hut Key is used at the snowmobiler's camp way towards the start of this level. Y'know, where the snowmobile was first obtained. The way back should be rather uneventful, although there will be a point toward the end -- a cave that now has a few leopards -- where the vehicle has to be abandoned.

HUT & BEYOND

Inside the locked hut: 2x UZI CLIPS, 2x SMALL MEDIPACK, 2x M16 CLIPS. There is also a switch that opens the locked gate nearby, unleashing three armed thugs into the area. They leave UZI CLIPS, AUTO PISTOL AMMO, and a LARGE MEDIPACK. Through the ungated passage, drop down into a huge cavern and find some high ground to knock the snowmobiler into the next life. Take the dude's ride and ride to the next abyss, using a side-ledge to bypass it (no turbo boost remember). That abyss has the GOLD DRAGON in a lower alcove, guarded by two waves of snowballs. An inner rim of the pit has a ladder that leads down, and if it completes the last in the trifecta, 4x UZI CLIPS are obtained too.

Back on the road, continue to the great outdoors. Tracks in the snow should indicate more enemy snowmobilers, and sure enough, two of them appear here when explored a bit. One slope they appear on has a walkable rim and provides high ground in case Lara wants to distance herself from the fray. When the duo's six feet under, go down to the slope's bottom and find the pushable block.

Through the hole, two gunmen will open fire on a ledge, and a third will too when Lara stands near the lip of the pit with a watery bottom. The object is to get down to that pool, and the easiest way by far is driving a snowmobile off the edge -- it barely gives enough clearance to land safely in the H2O. Look for a pull-up point on one side and the tunnel beyond ends the level.

The next one is probably my fave in the entire game. ^____^

12) BARKHANG MONASTERY

[WK12]

| NOTE: Do not harm any of the monks! They will act peacefully around Lara |
| but every monk in the level will turn on her if she attacks them! This |
| is a needless waste of ammo and/or health so watch who you're shooting!!! |
|

A: Monastery Entrance	J: Strongroom / Rooftops Key	
B: Upper Window (2F)	K: Rooftops	
C: Connected Passage (Ladder)	L: 2x Gemstones	
D: Main Hall Key	M: Boobytrapped Hallway	
E: Main Hall / Buddha Statue	N: Trapdoor Key	
F: Connected Passage (Ladder)	O: Pool Room	
G: 1st Prayer Wheel (Subsequent = *'d)	P: Outdoor Road	
H: Connected Passage (Ladder)	Q: Pool Drain Block	
I: Strongroom Key	R: Prayer Wheel Slots / Exit	

```
|_ |_____|  
|   *   |  
| |_____|  
| |_____|  
| |_____|  
| |_____|
```

2F MAP

____ N |

```
|_____|  
|_ |_____|_____|_____|  
| POOL | G
```

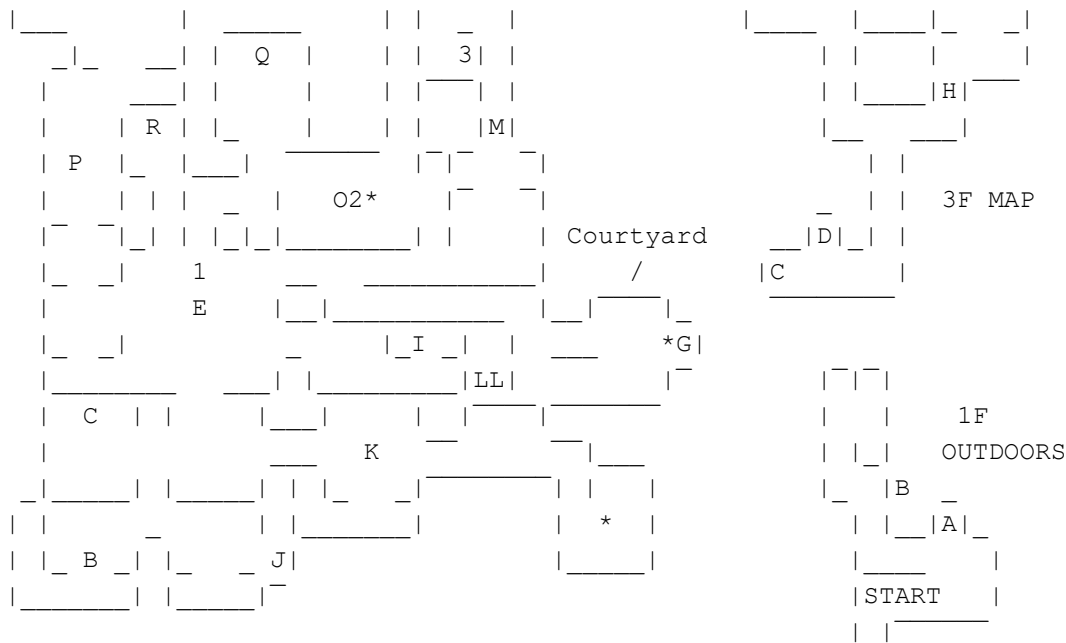

MONASTERY GROUNDS

A few steps into the level is the monastery's entrance, where the monks are having a scrap with some of Bartoli's thugs. If Lara watches from a distance, she can see the monks take care of themselves while she reaps the corpses' benefits: a 2x UZI CLIPS, AUTO PISTOL AMMO, and a SMALL MEDIPACK. It's much better this way...don't want any crossfire mishaps... There's a ladder near the stairbottom that leads to a crow's nest (literally!), and also a window sill near the top of the ladder -- the next destination.

From up here, Lara can drop down onto the silvery ledge and proceed through the rocky crag that covers the lower footpath. Face the building here and do a flatfoot jump, landing on a slanted portion. Drop-n'-catch it, then the natural groove below; shimmy to the window balcony.

MONASTERY INTERIOR (1st Prayer Wheel)

Break open a window and enter the 2F library. Walk a little ways in until a ruckus draws the monks away -- a Bartoli thug has infiltrated the building. They'll kill him if Lara keeps her distance, leaving UZI CLIPS and a SMALL MEDIPACK on one guy's person, and AUTO PISTOL AMMO on a second intruder's. The balcony they came out of has GRENADES, too. This 2F area has 3 locked doors in 3 different rooms, a chamber leading to a ladder and a room with rolling blades (as previously seen in "The Great Wall" level). Up the ladder on 3F is the MAIN HALL KEY, and there's an entrance at the other end of this catwalk.

Spring the boulder trap at the start, then do the same for the T-intersection immediately after. Take the FLARES from the bifurcation and take the incline up to a pool. There's a suction effect in the middle and the lip of the pool is too high -- save first, then swim around the parameter to the underwater opening. The surfacing point beyond leads to a watery shaft. Jump down, get past the lame metal clamp trap (x3) and climb the ladder to a one-monk room that soon has an intruder. Kill him and get the SMALL MEDIPACK, then kill his cohort in the darker room. This area also contains the 1st PRAYER WHEELS (yes, a singular is plural, etc.). Taking it activates a burner trap but it is a cinch to jump over 'em by using the space in-between. Back in the ladder room, pull out the two redwood blocks and reveal a passage beyond, a ladder that connects back up to the boulder-trap hallway on 3F.

MONASTERY MAIN HALL

Return to 2F and unlock the main double doors in the hallway to find the monastery's main hall, with its gigantic Buddha statue. This also triggers a couple henchmen at the entrance, but the monks should fend for themselves rather easily -- take the AUTO PISTOL AMMO, SMALL MEDIPACK, and LARGE MEDIPACK after the chaos. Surveying the room (facing the statue): one left room, a trapdoor in the hall, three right entrances, and a passage alongside the statue we'll avoid (leads to the exit...). If Lara chooses to climb behind the Buddha statue, there's an alcove with the GOLD DRAGON [1/3] inside.

We need a key at the moment, so take the first right entrance to find a li'l library. There's an adjoining passage boobytrapped with lateral blades; save before approaching and jump over 'em when spotted. The small antechamber with a monk in it nearby has the STRONGROOM KEY to take. Ignore the rest of the passage and return to the main hall, and from there, the area Lara first entered the building. One of the locked doors is made of old boards and can be flung open with the new key, revealing the ROOFTOPS KEY inside storage.

ROOFTOPS (2nd Prayer Wheel)

This key can be put to use nearby, in the room with the circular blades that roll around (like in "The Great Wall" level). Up in the fresh air, there's a corridor full of burner traps. A switch nearby will deactivate them but like always, it's on a timer. Save beforehand and repeatedly flatfoot-jump over 'em. The room immediately after has two monks who will go to combat the thug duo who's trailed you; they drop a SMALL MEDIPACK and UZI CLIPS. A ladder by there has M16 CLIPS at its peak. Pull the lower switch to trigger trapdoors nearby, which leads to 2x GEMSTONES behind breakable glass. A 3rd switch'll open a ladder back above.

In the hallway nearby, use one of the Gemstones on the weird asterisk-shaped door, pull back the movable block inside, and get another PRAYER WHEELS. Now return back to the main hall.

MAIN HALL (3rd & 4th Prayer Wheels)

Take the other right-hand passage and find the huge stack of movable boxes in one of the side rooms, arranged in a 2x3 formation of variable height. Two boxes on the nearest row can be moved back to find AUTO PISTOL AMMO, and if configured correctly, there's 2x HARPOONS under the only movable block on the top stack (although this is useless so feel free to ignore).

Follow the adjacent passage, keeping your eyes peeled for a trapdoor on the floor. Stepping on it drops Lara into a long shaft with a ladder, so step over it safely! Locate the stairway past there that leads to a long window. Four (!) armed thugs will attack Lara from behind here, so softdrop through the broken window to a courtyard filled with monks. The gate switch will let them fight the brutes in her place. The spoils of war: SHOTGUN SHELLS, LARGE MEDIPACK, SMALL MEDIPACK.

Return to the courtyard and find the series of ladders on one end, eventually leading to another PRAYER WHEELS. The way down is easier via softdrops! Now, return to hallway near the boxes and continue to the end. Another gunfight that breaks out when Lara nears a trap-filled corridor (burners, spikeball, etc.) is also wholly avoidable: UZI CLIPS, GRENADES. The adjacent hallway offshoot leads to a large pool. Jump in and look for a small submerged tunnel in one corner that leads to a SILVER DRAGON [2/3]. Now, back to the trapped corridor.

To get through, fall through the hole the two halves of a spikeball are swinging over, then pull up on the _inside_ lip at the end to avoid being

sliced by a rolling circular blade. Observe the next part: there's an active burner and two more halves of a spikeball immediately past here. The only way to proceed is to time a jump to the middle when the circular blade is on one end, then do a specific leap over the burner and into the hole beneath the spikeball. It's hard, so save first. The long hallway the 2nd rolling blade takes actually leads to the JADE DRAGON [3/3], behind some clamper traps. The bonus for collecting all secrets is 4x M16 CLIPS. The TRAPDOOR KEY at the hallway's end is for use in the main chamber, which is easily accessed as the passage ends with a slide into the large pool area.

At the trapdoor in the Buddha room, this leads as a workaround to the locked door from the main hall. Open it now for easier access, watching the monks killing the gunthugs launching another guerilla attack. They drop nothing, so continue along the new passage to an outdoor road, then to the end where a huge stone pillar holds up higher canyon ledges. Near a wooden bridge, a thug (M16 CLIPS) tries a pincer attack...with a crow. Yeah. Now's a good time to save, because across the bridge are two crows near a monk. Aim well, or better yet, lead the crows away to avoid hitting the good guy in crossfire. The building's locked so jump to the higher ledge on one side of the rockwall and then to the structure from there. Drop inside for the 4th PRAYER WHEELS, then leave again to help the monk fend off a baddie (SHOTGUN SHELLS).

MAIN HALL (5th Prayer Wheel)

For the final act, return to the Buddha statue's base and find an alcove at the bottom. The middle door on the right side of the room leads to a ladder, from which Lara can get jumping position to one of the statue's arms. Climb onto the next nearest arm, then do a running jump-n'-grab to the head. Spot the alcove on the opposite wall and do a flatfoot jump to it after descending. There's a final spot for a Gemstone, which lowers the trapdoors at the statue base. The passage leads to a door switch; move the block over the fountainhead to drain the pool nearby. Slide into the room (softdrop) and make a beeline for the movable block, which reveals the final PRAYER WHEELS behind it.

Return to the main room now and find the passage alongside the Buddha statue, leading to the sockets the five Prayer Wheels can be put in. Doing so opens a room where The Seraph can be placed, which actually opens the level exit...

13) CATACOMBS OF THE TALION

[WK13]

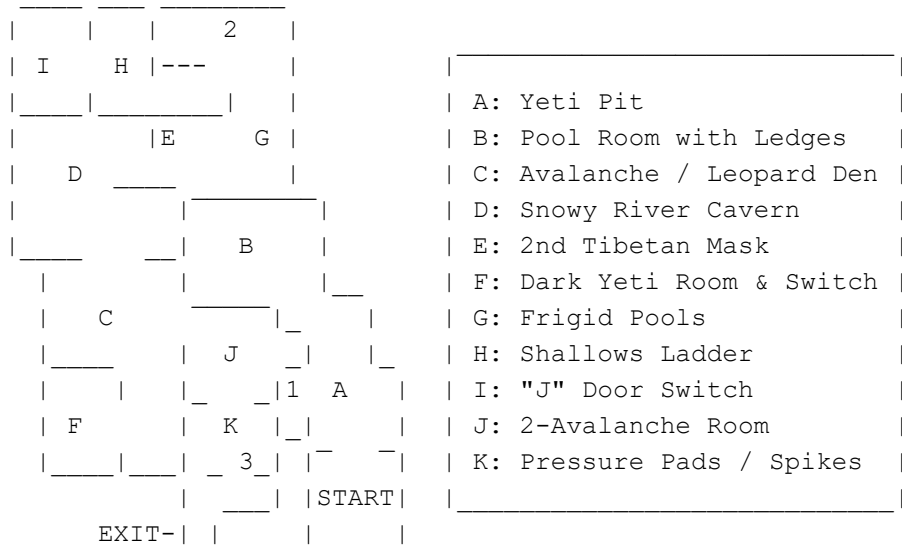

From the starting chamber, avoid the icicletraps above the stairs and find the huge pit adjoining. Look for a crack on one side, and shimmy to the pull-up point to find the SILVER DRAGON [1/3] and FLARES. On the way back to the ledge, a 'dangerous' SFX should play and a yeti will appear at the bottom of the pit. Going close-quarters on its annoying face is really the only option. When it's dead, flip the switch there that opens a door across the pit, and releases a snow leopard in the meantime. Back above, ride the slope and grab the opposite ledge. A leopard attacks there, but also watch for icicles above the steps -- this will be a common trend.

Enter the long room with a pool, and continue down the stairs. Near the end is a darker, sunken tile that triggers two gunmen's appearance from where Lara just was (2x UZI CLIPS, LARGE MEDIPACK, AUTO PISTOL AMMO). Before we do the climbing part, approach the door near the pool to spawn two leopards; through there's a SMALL MEDIPACK near a barred outlook point. More on that to come!

Alright, back in the pool room. We need to trigger the snowball trap first, which can be done by a bit of climbing near the entrance stairway: jump to the balls' slalom and trigger it before sideflipping into the pool. With that out of the way, locate the corner ladder with spikes. There's a half-slanted rock formation near a snowy overhang -- it's flat enough Lara can jump onto it! From there, save, run across the cracked tiles, and ascend the ladder. At the top is...nothing, so Lara has to do a blind backflip to the ledge by where the snowballs were poised; give clearance so she doesn't hit ceiling! [If the snowballs are still there, then Lara can't do anything but climb back down and backflip over the spikes.] The switch at the peak raises the cage Lara can slide to, obtaining a TIBETAN MASK. The pool trapdoor is now open! Get down there and softdrop to minimize damage, and avoid the spike pit to find a door whose key is the mask.

TWO-BUILDING ROOM & SNOWY RIVER

An avalanche starts as Lara goes up the slope, but they come at different times, so safe ground can be claimed rather easily. Four leopards then come to complicate matters. When the fuss has died down, search one area of the room for a ladder that leads to a ledge's 2x GRENADES. Both buildings are inaccessible for now, so return to the steps the avalanche was perched on and locate the huge oval-shaped hole in the wall. Jump to here to find the snowy river cavern next-door.

Slide down to the bottom and investigate the pool, disturbing a leopard den with four family members. A huge fiery cauldron is suspended above the frozen pond, so it's not hard to guess coming events. Kill two more leopards in a room with a glacial wall, then climb around a bit to find a non-frozen pool. Inside is a 2nd TIBETAN MASK, which we'll put to work right away -- return to the room with dual buildings after killing two wandering henchmen (2x AUTO PISTOL AMMO, SMALL MEDIPACK, UZI CLIPS).

One of the buildings has an socket for that mask, leading a pitch-black room with screaming yetis. Luckily, they're locked away. Pop a flare and find your way along one side of the room, where standing jumps can lead across mini platforms to a switch. This unleashes the yetis and connects the platforms, leaving Lara a sitting duck! Since yetis can climb, I suggest leaving back outside to pick 'em off. Search around the cells afterward to find a treasure trove: 3x GRENADES, 2x LARGE MEDIPACK, 2x UZI CLIPS. See the movable block at the top of the stairs? Move it into the nearest doorway so it rests on the floor grate under a raised gate. When Lara pushes the switch behind there -- which opens the eye-insignia door near the snowy river portion -- all gates close again, but the movable block keeps them open! Three henchmen will be in the buildings' vicinity now (2x SHOTGUN SHELLS, SMALL MEDIPACK, UZI CLIPS,

2x AUTO PISTOL AMMO). Climb into the oval-shaped alcove that leads to the snowy river portion to find the opened door.

Anyone can spot the obvious avalanche trap therein, so when it triggers, move to the "left" ledge right inside the glacial wall room (where Lara got the 2nd Tibetan Mask below). Jump to the hanging ladder, then find a drop-down spot into a frigid pool with some barracuda (!?) inside. Along the 2nd pool's dryer ledge (tinged with icicle traps) is a ladder into the ceiling. Save and climb, backflipping over a slanted ledge and to the JADE DRAGON [2/3]. Back in the wet stuff, swim to a locked double door in the shallows. There's a small climbing course on half-submerged pillars leading to another ladder. Backflip to the door's switch and hurry inside to a switch that opens the remaining doors in the 2-building area...kill the leopard first, though. The easiest way to get down quickly is take a running jump off the brazier's handle, onto some slanted rocks below.

The doors that were opened lead to...another avalanche trap! Actually, two of 'em; below are some aggravated leopards. The first trap to set off is the one aligned with the weird funny-lookin' ice block, which breaks on impact. The other trap leads into the leopard pit and has a hair trigger, meaning as soon as it goes, backflip, then sideflip to avoid making a red snowball... The 1st trap can be jumped over or sideflipped away from, doesn't matter. With that out of the way, kill the leopards below and steal their stash of GRENADES, LARGE MEDIPACK, and M16 CLIPS. The door switch unleashes another so beware! Return to the avalanche slopes and enter the way one broke open, which is "K" on the map.

2-DOOR SPIKEPIT (LEVEL EXIT)

The two weird wooden tiles open doors here, although only one works now (and is timed). Take it to an L-shaped series of spikes, and look for part of the wall that's bolder; it's actually a ladder up to the GOLD DRAGON [3/3] and its tag-along prizes of 2x GRENADES & 2x M16 CLIPS if that's the entire set. Descend in your preferred way.

Now, an overview. We already know one wooden pad controls the left door, but the right pad actually controls the exit door! The right door opens only when approached from behind (spike room) and closes only when stood in front of from the snowball room. So, with this info, the way to proceed is...

- 1) Enter the spiked room and approach the right door from behind, opening it
- 2) Jump over the lower pressure pad, then the snowball, to the level exit pad
- 3) Run right through the right door, making sure to jump over the low door pad
- 4) Enter the exit before its timer ends.

Voila! If you find it hard, you can always save before stepping on the level exit pad and keep trying from there. Anyway, do a running jump to the ladder within, then follow the path to put this one in the books.

14) ICE PALACE

[WK14]

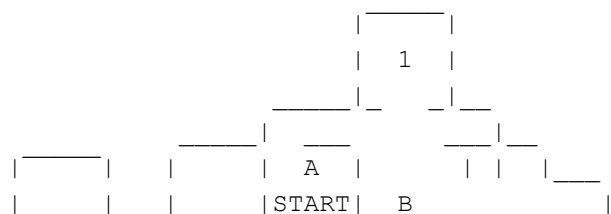

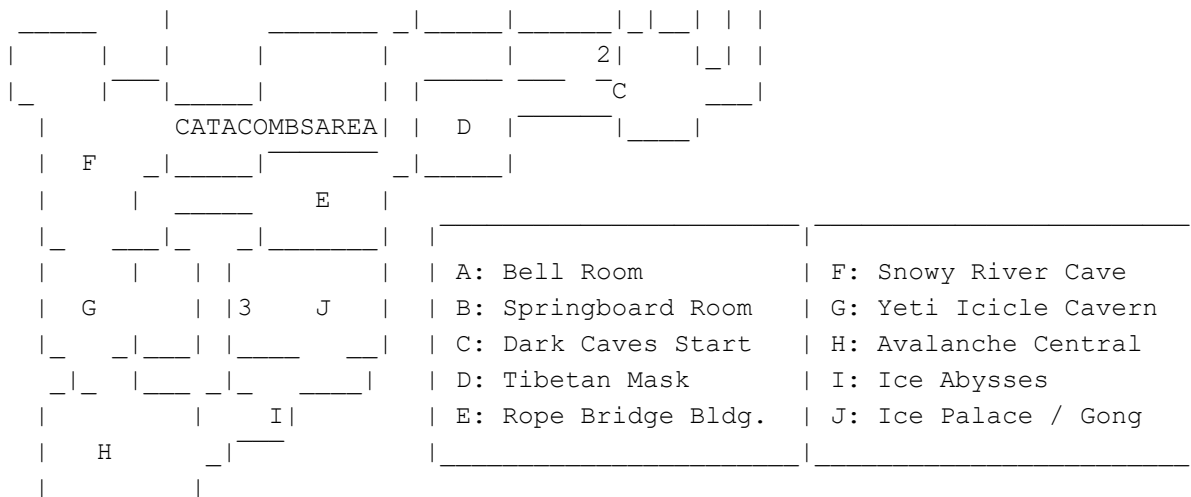

THE BELL ROOM

In the starting room, shoot the bell to open the door that leads to the larger room with yetis. Luckily, they're all caged! Haha, suckers... Anyway, notice the weird trampoline tiles on the ground? These springboards will skyrocket Lara upward in the direction she's moving when she touches them. They're great for getting higher but if you hit one accidentally, it can be a long plummet to the floor, if y'get my drift... For now, climb up to the 2F platforms via some pillars near a cage, getting the LARGE MEDIPACK in a lonesome corner.

Back on the ground floor, find a single springboard near a 2F bell perched above a slope. Spring up and shoot it in midair, raising one of the room's exit gates nearby. For the next part, stand by the two boards side-by-side and run in the direction of the exit gate, which springs Lara upward to a 3F ledge she can catch. Pull up, get 2x UZI CLIPS, and flip the switch -- it lowers the yetis cage but gives access to the small connected tunnel adjacent. The player should already be able to see the LARGE MEDIPACK inside, but there is also a switch guarded by a 4th yeti; this raises the window shutters on the exterior. Before leaving, look near the tunnel's opening for a wall block that can be pulled out to reveal a large room with the GOLD DRAGON [1/3] on a pedestal far across. In actuality, there's an invisible bridge to the relic, which is why there's only a ladder out of the pit. Locating the bridge is as simple as aligning with the artifact and doing a jump out -- it extends all the way to and back.

Return to the exit gate area, save, and run diagonally to fly up to the shutters' new platform -- this gives access to the 2nd bell that will finally open the room's gate. Beyond said gate is a final springboard. Take it up to a dual slope, then shimmy to the far wall near where the 3rd bell is. Shoot it while jumping/backflipping on the slopes to raise the gate opposite there. To get there, return to the springboard below and jump in that direction. Climb the ladder to reach the 4F of this vicinity. Jump down to the snowy pillar where FLARES are and a yeti intrudes from one of the alcoves, the start of a dark cavern.

DARK CAVERN COMPLEX

Kill the Bengal tiger lurking the lower depths and find a SMALL MEDIPACK in one of the footpath ledges. The ledge opposite there has a SILVER DRAGON [2/3] through the dark passage, and a locked door near there, too. Return to the footpath and kill three more tigers in the ensuing room. Our old friend the TIBETAN MASK is sitting on a pedestal here! Return back to the footpath ledge with the locked door from before...and it'll be unlocked. Follow the path to a barred outlook over a large chamber. There'll be yeti to dispose of a li'l ways down the drop-down points, and a 2nd one walking the ground below the

dark recesses of the unlit braziers. Drop a flare down there to see plenty of spikes! Lara can snipe him from there, or should be able to, at least. Take the LARGE MEDIPACK at the end. Once he's dead drop down near the end and take 2x AUTO PISTOL AMMO from a corner, then a SMALL MEDIPACK from the red balcony overlooking the snowy cave below.

Said red balcony has a slot for the Tibetan Mask, which opens the wooden door back in the spike room. This leads to...

CATACOMBS OF THE TALION REVISITED

Yup, the bridge accessible now outstretches across the 2-building courtyard where so many fun things happened previously. Some doors and whatnot are closed, so don't get any ideas about doing any retreads. There are FLARES off to the left, however. Follow the bridge to the snowy river cave and jump to the switch nearby to dump lava (!?) into the pond, melting its surface. Slide down (softdrop from same ledge to angled rocks below) and approach the glacial wall room where a few tigers have set up shop, getting the 2x SHOTGUN SHELLS when they're dead. Check the small pool where the 2nd Tibetan Mask was last level and get 2x UZI CLIPS while yer at it.

Now, jump through the melted pond to find a GONG HAMMER. Past two soon-to-be dead flesh-eating fish, surfacing in the cavern with some yetis and ceiling icicles. When they're rotting, get a SMALL MEDIPACK that triggers a 4th yeti invader. There's another door in this area besides the one atop the iceblock pillars, guarded by a single icicle. Bypass it and kill the yeti inside for 4x GRENADES -- yummy! Now, return to the iceblock pillars near where the Small Medipack was and climb up.

This next slope is avalanche central -- there's about 10-11 of the boobytraps to trigger! A few will put Lara on edge near the start, and as she tries to run down the slope, all the rest follow. Keep running and find high ground to escape the frigid wrath of the snowballs. The path beyond leads to icy abysses with dual slopes. Like before, either repeatedly jump/backflip to the flat part (use camera POV) or softdrop-n'-catch the nearest ledge and shimmy to a backflip. There's a huge glacial wall of ladder-like proportions now. Climb all the way to the alcove, do a softdrop-n'-catch down the slope and hang above the gong. Drop down to safety...although the fall takes half of her life away.

Before striking the gong, locate a ladder near the corner, stretching down into the abyss that surrounds the Ice Palace's. Use Flares to see where Lara is going, and drop down the right side to find a switch that opens the small shed near the palace (if you find spikes, you went the wrong way). Inside the building is the JADE DRAGON [3/3] and it hopefully brought pals: 4x GRENADES. Now, climb back up to the gong by going around the left side of the palace (in the corner) where some ledges make it possible. Bang a gong, get it on~~! Doing so will blow open the suspicious-lookin' ice wall near where Lara just climbed up, letting her claim the TALION within!

Slide back down to the palace base and...a boss appears!!! His punch can take off about one-third of Lara's health, but it only takes about 300-400 uzi ammo to take him out. If you want, get the 2x UZI CLIPS and LARGE MEDIPACK in his little cave, 'cause once he dies, the level ends automatically. Yay!

A: Dagger Chamber	N: Spiked Ceiling Room
B: Waterfall (Above)	O: Changeable Water Level Room
C: Waterfall (Below)	P: Connected Passage (1-way Tunnel)
D: Ornate Building	Q: Connected Passage (Tunnel)
E: Lava Shaft	R: Spider Cave
F: Spike Pit	S: Silver Key
G: Terracotta Army	T: Silver Key Door
H: Slanted Slope Series + Lava	U: Rope Bridge (Connected Passage)
I: Spikewall Room	V: "X" Room Switch
J: Metal Boulder Traps	W: Springboard Slope
K: Dark Room	X: Main Chamber
L: Spikebarrel Room	Y: Main Chamber Key
M: Narrow Bridge/Dragon Statue	*: Connected Passage (Stairway)

This is the longest level in the game...have fun. >_____>

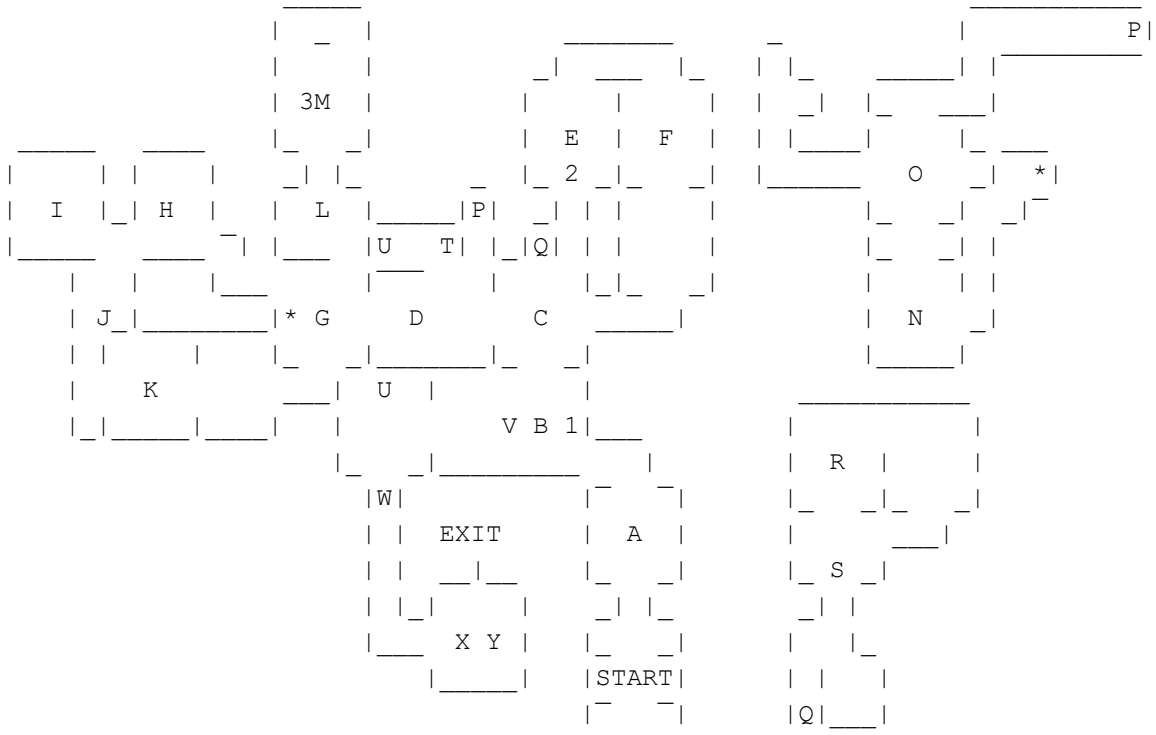

WATERFALL, ORNATE BUILDING, LAVA SHAFT & SPIKE PIT

...and it all comes back 'round to The Great Wall again! Continue to the room with a suspended pedestal and a long fall below. The blacker tiles that surround the pedestal drop down, preventing her from getting the dagger seen in the main menu FMV. Fall through the nearest tile and catch the slope to softdrop down to a long course. Jump over the blade trap and ignore the boulder trap, as it bypasses Lara. When coming to the wet slope leading to a waterfall, make sure to jumproll so Lara faces up the slope, letting her catch the edge before the fall. Shimmy to the GOLD DRAGON [1/3] alcove from there, then let the current below throw Lara over the falls. Surface by the ladder and kill the jaundice-colored fish who are hungry for braiiiiiiins. Ignore the keyhole/ladder/gate and find the underwater opening that leads to a new cavern.

On the right side, before surfacing, is a long tunnel where a SMALL MEDIPACK rests near a red gate; a key is beyond. Hmm... Kill the tigers that emerge from around the ornate building and find SHOTGUN SHELLS on a pool ledge. Use the springboard alongside the double-door gate to reach the roof, whose switch opens the trapdoor above the ladder near the waterfall's base. Kill a condor, softdrop down, and head there. A spider in the alcove above heralds the shaft with a lava bottom.

The ledge Lara drops down onto has a ladder portion, so she can drop-n'-catch to the ledge that has a crack running to another ladder. Do the same to reach the ladder near lava-level, then shimmy to the SILVER DRAGON [2/3] and back. There's a 3rd ladder that goes up the opposite side of the room, leading to a room with spikes.

Safely drop in there and climb the ladder-wall, and shimmy to the wall (so Lara's above lower pit). Backflip to the slope, then immediately jump forward to reach the upper spike pit's safe tile. There are some breakable tiles over lava now, and Lara can see a SHOTGUN SHELLS underneath the farthest. Go there and fall to it, then jump to the slope across the lava. Before hitting the spikepit beyond, leap over to an slope, then immediately jump again to catch the ledge of a flatter ledge. Whew! From here, collect the GRENADES in the spikepit's safe zone and flip the switch above, opening the double doors in the ornate building cave. Jump into the waterfall pool and swim there now.

TERRACOTTA ARMY ROOM, PT. I

Inside is a host of terra cotta soldiers, and some mechanical sword-holders that are programmed to swing their sword vertically when Lara's near. Get the M16 CLIPS from the safe spot and enter the only door available, climbing up to another lava cavern a series of slanted rocks. Save first and jump to the nearest slope, then three others in succession, finally finding a ledge that can be caught. It can take a few tries, but make sure Lara is always facing forward! Climb up afterwards and jump to the exit, saving before entering the passage.

There's a false switch here, and the trapdoor will send Lara into a room below. Avoid damage falling to the slope by softdropping there, then roll at the bottom. A spikewall trap will try to smush Lara, but as long as she runs to the switch, rolls, and runs straight away from it, she should find the passage that gives safety. The adjacent passage has a slope where a metal boulder will be set off immediately; roll and run out of its path. At the top of the slope is another trap, only this boulder falls from the ceiling and gives little leeway to avoid. Climb up a little farther to find a 3rd trap of similar design, then a ladder upwards.

Below is a pitch-black room. Save and descend with a flare, finding a switch that opens a passage up the wall near there and sics a tiger on Lara from behind. Climb into the ladder shaft with a flare in hand. Blade traps will be guarding this passage but are already visible. To bypass, jump above the first and descend as far as possible without damage; time a fall past them, then re-catch when safe. At the bottom is a small room with rolling circular blades, both guarding the exit...but a timed jump will circumvent. This will lead back to the terracotta soldier room, with two condors to kill at once.

The button on one side of the 2F area opens the door opposite there. Lara has to cross the rafters to get in, but luckily a bunch of running jumps in succession will get across...in fact, that's really the only way to do it. Beyond are spikebarrels swinging across a path flanked by lava...yikes. Two buttons are on the other side, one controlling the exit and the other raising a temporary bridge across. There's little room for comfort here, so press the right button, sideflip to save time, press the left, and dash over breakable tiles to the next room...except a boulder is hot on Lara's tail. Due to the camera angles which zoom out ("cinematic"), the easiest way to get evade its clutches is to continue straight along the narrow bridge and jump at the end to grab the bridge. Pick up THE DRAGON SEAL after pulling up.

Pull up to the alcove behind the dragon statue to find spiders guarding a switch and 2x AUTO PISTOL AMMO; there's another single-serve of this same ammo nearby, too. The switch changes how some of the lava room is configured, destroying the bridge. Save and go down the dragon's left side (as if you were facing statue from front) and jump across the two flattest blocks. There are now two slanted ones and a flat that once formed basis for the now-broken bridge. The object is to jump to the first slanted, catch the second, then slide down the other side and reach the tall flat. Definitely save before doing this -- it's hard to get in position from the first jump -- then save afterwards, too! Jump along the right side of the room and the last tile, which has a decorative pattern, will be a springboard.

Save before jumping, and hold 'forward' during the jump, reaching the multi-ledge part of the room. Like its forebear, another boulder trap immediately springs. Hang off the ledge to avoid its fury. There's one more boulder trap on the next ledge, but jumping to the 3rd ledge will evade. From there, it's a simple task to jump along the flat spots. Climb up to the 3rd-from-highest ledge and save. The slope alongside leads to a springboard, which will vault Lara to the wooden walkways high above the lava. Do a running jump to a JADE DRAGON [3/3], getting 8x UZI CLIPS in the meantime (!!!). From there, leap back to the ledge series and climb all the way to the upper corner. The room at the top has a movable block with a hideous face, revealing a corridor behind. Pull the switch, drop through the hole to the top of the avalanche trap, then run down, sliding through to the terracotta army room. Snipe the tigers just for the hell of it.

TERRACOTTA ARMY ROOM, PT. II

Use 'The Dragon Seal' on the locked door in this room. Descend, getting past the passage with a rolling circular blade, then sliding into a room with a spiked ceiling. There are plenty of levers here, but the one nearest the waterfall is the correct one. Get the SMALL MEDIPACK before escaping! Climb the ledges near the mini-waterfall. Kill the fish inside and save.

Pulling the submerged switch will flood the entire room, giving access to two surfacing points (one with LARGE MEDIPACK & GRENADES, one with a locked gate) and the long channel whose current has been cut off. Get the items first and save, because this next part is annoying and requires a bunch of parts.

- 1) Swim down channel (ignore water-level switch), swimming to adjacent alcove
- 2) Flip switch to open new gate opposite [maybe get SMALL MEDIPACK later]
- 3) Flip lever inside there, opening the large red gate near waterfall's top.
- 4) Pull lever in the #1 long tunnel, returning water level to normal (whew!)
- 5) Inside #3's switch, a lever that opens red gate in a surfacing point
- 6) Raise water level again and go to surfacing point in ceiling

Kill the fish in the next room, pick up 2x SHOTGUN SHELLS on the pool bottom, then M16 CLIPS on the dry pillar. The hallway nearby has a spikewall trap in plain sight, so save? Run in and pull the switch, then fall down the far end to an underwater channel that brings Lara to the GOLD KEY near the surfacing point outside the ornate building. The Gold Key will unlock the gate at the waterfall's base.

In the underwater passage beyond, at the first bifurcation look for a small passage near a hideous face block. Once Lara enters, the gate shuts her in with a fish. Look behind the 1st pillar for the lever that opens a door back out. Surface and kill the fishie, then get the SMALL MEDIPACK within that room. The lever also opened a ceiling hole across from the hideous pillars,

so swim up and surface, killing another fish.

SPIDERLAND & 2ND BUILDING

No, not the seminal Slint album! The wooden walkway leads to a dark cave full of creepy-crawly spiders, some tiny and a few of them gigantic! There's UZI CLIPS and FLARES en route to the next cavern, which contains a disgusting sac attached to the ceiling. Kill any superspiders and locate the lowest block that can be climbed on; it has a reddish tinge. There's a small course to navigate through jumping from there on, all of similar color. Upon reaching the L-shaped ledge, be prepared to kill another large spider. Kill it and leap down to the center pillar -- from there it's a few hops to the exit on the other side of the room.

This upper ledge leads back to the nearest surfacing point. A running jump-n'-grab will reach the formation with a SILVER KEY at its peak. Return to the terracotta building's exterior and find the locked gate that can use this key. Inside is a slope with a few ledges. It's child's play, but a metal boulder will roll over when our gal climbs on the 2nd & 3rd blocks; hang off the edge to evade. Get the AUTO PISTOL AMMO and head onto the rope bridge, where a team of tiger & condor attack. A second tiger lies in wait across the bridge.

Backflip off the lowest pillar here to get access to two upper paths. The one with a rolling circular blade. Do a diagonal jump to its path, then jump out of its way to the next path. Slide backwards down the slope, catching the ledge a few times to UZI CLIPS. You'll have to backtrack all the way up here again if this is done, though. By the rolling blade is another hole with an inert circular blade. Get the LARGE MEDIPACK and 2x UZI CLIPS by the skeleton and progress over the bridge, which is at the top of the waterfall. The button there opens a door somewhere, and also sets the circular blade in motion. Oh, and it lets a bird in...meh. Follow the blade back across the bridge.

Now, the other passage we skipped before has a steep slopes with springboards up it. The best way I've found is to do a running jump to the 1st springboard and bound up the slope that way. This can be an annoying jump due to the ceiling above the 1st springboard, so save first in case Lara gets stuck. If you're still having troubles, don't hold action down at all until coming to the final springboard; Lara should catch the ledge instead of hitting it. Nix a bird who appears after, jumping to where it came from. The doors should be open thanks to the previous switch.

LAVA CHAMBER & EXIT

This room is a dead-end but it's got plenty to do. First, jump across the level platforms to the spikewall trap. Get to the ladder alongside and climb like the wind, up to a small passage with a 2nd spikewall trap. Jump to the ladder within, finding the switch within -- it opens a gate we just passed. A dragon statue is coiled around a pedestal. Jump-n'-catch a few brownish platforms around the pedestal before claiming the MAIN CHAMBER KEY. Save and slide down the statue's neck, jumping at the last second to a flatter block. From there, jump back to where Lara came in, between the statue and open door; it can be semi-hard.

Return to the lowest spikewall and use the key, making a small platform so Lara can use the ladder on the far side. Climb up, find the next ladder, and return to the hallway that gave access to the Main Chamber Key. The door to the final coiled dragon sculpture is available. Across the platforms, slide briefly and jump to the flat neck portion, giving access to the ceiling. Keep climbing until coming to a blade trap; backflip to the slide, then jump to a new ladder. There's a 2nd blade here. Position Lara a few runs below it,

then backflip-roll, catching the ladder behind her. It's hard but possible.

Climb to the top, dismount. Follow the passage to end the leve. Man, this sucker was l-o-n-g!

16) FLOATING ISLANDS

[WK16]

```
      |_____|_____|
      EXIT  N      M  |
      ____| ____|_  _|
      | ____|  |  |  |
      ____| |_____| L  |
[G] ____|3 | _ _ J| ____|
__| ____|_____|  |  | K  |
|_ F  EH2  G  I____|____|
|____|_  _|_____|
|_____|
|____|_  _|
|  _|  |  |
|  _||  | /  \
|_ |  _  ( D _| | |
| B|____  |  |
|_____|  |  |
|_ |_____|  |  |
|  _  _  _|  |
|  _| A|  _ C1 |
|  |_____|  ____|
|  _|_  |
|  |  |
|_____|
START
```

A: Mystic Plaque
B: Trellis Building
C: 3-Guard Building / Mystic Plaque
D: Small Jade Island
E: 2-Plaque Gate / Garden Entrance
F: Dual Boulder Traps
G: Zipline Island
H: Zipline Gate Switch (Below)
I: End of 1st Zipline (Post-"H")
J: Switch Below Lava Waterfall
K: Dark Spikepit
L: Cage Slide
M: Lava/Spikepit Trellis
N: 3rd Zipline

FLOATING ISLANDS

Many players hate this level for a reason, yo. Walk out onto the jade ledge and look at the temple below. There should be a floating statue approaching after a li'l while -- take him out from that elevated position, maybe with the M16. On one side of this area is a small bunch of ledges that'll allow Lara to descend near a kneeling statue -- this can be ignored for right now.

On the jade ledge, survey the area. There is a building with a trellis around its edges and two more jade formations, one of which is triangular and has two slanted sides. Save, jump to the triangular jade formation, then jump to the other mid-slide. From here, Lara can reach the trellis structure with one more jump. [If she falls, she slides down near the kneeling statue and it'll activate.]

Locate the switch that opens a ceiling trapdoor on the temple island nearby. However, before going across, let's get the MYSTIC PLAQUE at point "A", which is under the triangular jade block. Backtrack there by jumping down under the trellis entrance (the one we just came through) and climbing back up. Get the SMALL MEDIPACK on the ledge if not done previously, then get back to jumping position. When leaping to the triangular block, make sure to go down backwards and snag the ledge, softdropping to the platform below (damages). From here, it's an easy jump to said Mystic Plaque, then a running jump to the small island near the temple -- that's the destination.

Two of the statues here will come to life, although Lara can take them out one at a time. I recommend shooting 'em from that small jade island as they move a lot slower in the air. Climb into the ceiling trapdoor opened and find a 2nd MYSTIC PLAQUE, plus 2x UZI CLIPS, FLARES, and a LARGE MEDIPACK. The final statue below has awakened and can be destroyed in the same manner as before. [NOTE: Sometimes the statues don't awaken in the right order.] The player may have noticed the JADE DRAGON [1/3] on this island's roof at some point. To get it, look for a pull-up spot near a cherry blossom tree, then jump to the roof from there -- easy-peasy.

Now, on one side of the island, near the platform where the guards were, hang off the side and fall-n'-catch the ledge below. Look for a lever that raises the gate and gives access to a jade island previously unreachable. From here, do a running jump to the next island, then 'cut the corner' by jumping over the slanted portion. Lara can now start jumping to the small islands that're situated underneath the trellis building's back end. Eventually she should be able to get onto that jade formation's top.

NOTE: If the only Mystic Plaque you obtained was from the 3-guard island, Lara will have to run along the jade formation and return to the trellis building to get the missing piece, then backtrack. Tsk tsk...
--

From the trellis' building's jade formation, Lara can jump to the next large island. Before doing that, though, the two kneeling statues come to life and start encroaching. Take them out before leaping, then place both plaques to activate the door. Get the 2x UZI CLIPS and see what's inside...and it's a garden! Aww...

FLOATING GARDEN & ZIPLINES

From underneath the bridge is another reanimated statue. When it's dead, see that a zipline extends perpendicularly underneath...hmm. Face the bridge and look on the "right," for a small tunnel partially obscured by foliage and whatnot. This leads to the SILVER DRAGON [2/3]! Backtrack by doing a running jump over the slope and into the tunnel again. On the left side of the bridge is a jade boulder. Save, then backflip over it, sliding down a ways. Catch the edge to make the rock sail harmlessly into the bottomless abyss below. On this gray platform is a SMALL MEDIPACK, but take care of the levitating warrior who appears first.

Enter the square hole in the jade formation, then use the pillar to climb to the ceiling, emerging onto the roof that gives access back to the bridge area. Redo the boulder trap, this time without the boulder -- jump to the ledge that extends further and is level with a small island that contains the zipline. Ride it and jump of near the end to the bridge below.

Peek into the adjacent room to find three guards, one of whom reanimates at once to harass our gal. Pull the switch behind his place to open a gate at the end of a 1st zipline; also, the rest of the freaky statues awaken. I suggest using grenades in this close-quarters combat sitch-ee-ation. Take the zipline and hold X-button the entire way, grabbing the trellis on the other end (rather than swimming in hot lava). Climb near the top, get onto the ledge -- Lara will be near a roof on one side of the upper bridge vicinity, which should be familiar if Lara went to the bottom of the boulder trap. Hang down and shimmy to the gray platform below, which leads back around to the bridge area. Return to the 1st zipline now and ride it all the way.

LAVA ROOM & CAGE

Pull an about-face and do a running jump to the area just sailed through, which contains a wall of fire and automated traps that shoot little blades. Kill the floating guard that emerges from the fire wall and pull the movable block alongside the central pit, giving access to the platforms above. The switch on the column will create a block toward the bottom of the central pit. Get 2x M16 CLIPS up there, drop down, save, and go down the slope forwards, jumping near the end to reach that block. The switch opens a grate in the lava waterfall. Get out of the pit by climbing up near the blade trap.

Anyway, return to the previous switch platform which overlooks the lava door just opened. Do a running jump and hold X-button in the air, weakening the arc and falling into the water below the lavafall. SHOTGUN SHELLS are on the bottom -- yay! Pull the switch here to raise a 2F gate above where Lara came into the room via the zipline. Swim through a small passage in the deep end and surface in a flooded chamber with lateral bladetraps. Pull the switch to shut 'em off, then trudge to the exit at the other end of the room. This time, push the movable block closer to the zipline dropoff point so Lara can do a flatfoot jump into the entrance.

Now, alongside a shut gate is a room with spikes at the bottom. Do a running jump to the dark side, then shimmy to a pull-up point hiding the gate switch. I found it impossible to jump back near the gate, so face the lower passage and do a flatfoot jumping, using X-button to weaken the arc for a safe drop. Backtrack to the gate, which may or may not trigger a flying statue depending on how Lara moved around previously.

Behind the gate are two ornate gates (locked), two still-unactivated statues and a large trapdoor/slide combo in the room's center. Slide down into the pit to find...a cage! With cultists and stone statues on every which side! Pretty lame. Pull the switch to raise the cage, then scramble to the high ground near the drop-in point to take out the human scum (they throw knives). Use something fast like the uzis to take 'em out, then save before killing the statuesque statues. The reward for taking lives is taking commodities: 3x SHOTGUN SHELLS, SMALL MEDIPACK, LARGE MEDIPACK, 3x UZI CLIPS.

There are two levers here besides the one that raised the cage. One opens the level exit above, the other opens a stairwell with a cultist (LARGE MEDIPACK, AUTO PISTOL AMMO) that leads back to the upper walkway around the cage pit. The two statues from before will awaken but Lara can conserve ammo by running to the trellis inside the other door -- with lava and spikes -- and climb up before they can beat her with their spears. Climb up and position Lara about 5-6 rings below the top. Like in "Temple of Xian" last level, one must do a backflip-roll and grab the trellis aft. Again, this is done by backflipping and pressing O-button immediately, then holding X-button. If all goes well, she's free to keep climbing up again and...do another backflip-roll-n'-catch on the 3rd trellis. Make sure to position her about 6 rungs below top like before.

At the top are some slopes and a blade trap shooting the length of the place. Pull up onto the slope, backflip over the trellis' pit, then sideflip or jump forward to get onto solid ground. A cultist immediately attacks in the cramped conditions so level his face in your preferred style (try to get behind him or use grenades). He just leaves SHOTGUN SHELLS... There's a 3rd zipline overhead, but can't be used until the movable block is positioned underneath -- this stops the blade projectiles in their tracks.

Before exiting the level on the zipline, there's one final secret to claim. From the corner where the block was, jump diagonally near the firewall and go its length. Jump over the center firepit to a flat block, then look for

a secret tunnel underneath where Lara just jumped. This leads all the way back to the floating garden area, where the GOLD DRAGON [3/3] can be found on the walkway overlooking it. For finding all secrets? 8x GRENADES! Score!

To exit the level, return to the zipline room. Jump straight across the pit to catch the slanted rock, then backflip to the upper ledge. Just jump to the exit from there, or return to the zipline if you wanna be a showoff. :p

17) THE DRAGON'S LAIR

[WK17]

This level's short enough that it doesn't need a map. Note that this is the final 'real' level in the game, and as such, feel free to use as many good weapons -- grenades in particular -- and medipacks as needed. Just save some for the final boss!

To start, pick up all the items near the start: LARGE MEDIPACK, 2x UZI CLIPS. Brush past the stone warrior into the adjacent room which has three more stone warriors, one of whom reanimates right away. If you want a good tip for this part, know that the warriors can be damaged when they're in their initial state! Shoot 'em up with grenades [etc.] and they'll be a cinch when they wake up; heck, they may even die instantly. Either way, find the switch near the doorway and pull it to reactivate two warriors. There's a new entrance behind where one was located.

In the dark room with pillars, there are two cultists (2x UZI CLIPS and a LARGE MEDIPACK) that need to be put down. Heal up at this point because as Lara approaches the locked gate on one side, four more cultists appear en masse! They leave 4x UZI CLIPS, a MYSTIC PLAQUE and a SMALL MEDIPACK. That artifact will operate the gate there. Slide into the room beyond and approach Bartoli's body...

FINAL BOSS: Bartoli Dragon

The room's layout is as such: a vast chamber with a few pillars and holes that lead to a watery underside. Down there are various items Lara can use: 10x UZI CLIPS and 2x LARGE MEDIPACK. The dragon above won't be able to harm Lara when she's underwater, but it still (semi-)follows her position when she's around there. Why? The dragon's a mystical creature; it's like that.

As for the boss itself, it has two attacks. The first is its fire-spewing flamethrower attack which, naturally, can catch Lara aflame. It can be dodged by flipping out of its stream, or by staying in the water. Worst case, Lara has to take a swim to avoid being barbecued. Its second attack is a stomping that attacks Lara up-close. If she's not up-close, it won't be used much. Naturally the most opportune position is staying behind the dragon; it has a pretty poor turning radius.

Although there's plenty of Uzi ammo in the water, the best way to go about this battle is to chuck grenade after grenade at the beast. It takes 12+ to stun the beast, which gives off a flickering effect that's also visible in the water (in case Lara didn't see the hit connect). At this point, Lara must approach the dragon's stomach -- yes, just like in the opening video -- and remove the DAGGER OF XIAN, finishing the fight. It's not a bad idea to save when the dragon is stunned initially, because pulling the dagger out can be a bit trying.

Once the dagger is in the inventory, the place starts to collapse! A door by

the dais Bartoli was on has now opened. Run through to finish the level.

18) HOME SWEET HOME

[WK18]

This is a kind of epilogue level that takes place in Lara's mansion -- which should be a familiar layout since it's been available from the get-go -- that has Lara taking on the rest of the cultists. She starts with no weapons, just the GUN CUPBOARD KEY and DAGGER OF XIAN. The gun cupboard is right near her bed, and contains a SHOTGUN, 27x SHOTGUN SHELLS, a SMALL MEDIPACK, 2x LARGE MEDIPACKS, and 2x FLARES. Lara won't have enough time to collect them all before some a clubthug, a gunman, and their dog enter her room though. I suggest waiting in the gun closet and picking them off that way. Another guy will infiltrate through the bedroom window.

When they're all dead, collect the SHOTGUN SHELLS one leaves behind and go downstairs. A dog will be here if it wasn't killed already. There won't be any enemies outside when Lara inspects but by approaching the van, a bunch of cultists, most gunmen, come out of hiding: 3x dog, 2x clubthug, 5x gunner. One leaves a SMALL MEDIPACK. Visit the training course on the right side of the mansion, killing another gunman near the starting point. At this point, start returning to the front entrance, meeting a dual-pistol-wieldin' gunman (last seen in the Opera House level). He takes about 8 close-range shotgun blasts to kill but it shouldn't be too hard if medipacks were consered. Just remember to jump over him and roll to shoot his exposed back, etc.

```
\_ _ /|\   /|(  ___ \ (  ___ \ ( (  /|(  _ \ ( )
   ) ( | )  ( || (  \ / | (  \ / | \ ( || ( \ ) | |
   | | | ( ) || (  _ | (  _ | \ | | | ) | | |
   | | | ___ || _ )   | _ )   | (\ \) | | | | | | |
   | | | ( ) || (  _ | (  _ | | \ | | | ) | ( )
   | | | )  ( || (___/\ | (___/\ | ) \ | | (___/ ) _
   )_( | /   \|(_____/ (_____/ | /   )_(_____/ ( )
```

Feel like reminiscing with some previous levels? Lara will have all weapons and unlimited ammo & medipacks. Kill all creatures, great or small, with grenades! Haha...

SECRETS

[SCRT]

Unlike other Tomb Raider games, secrets in this game are always Dragon artifacts that come in three colors: Gold, Silver, Jade. Items are awarded only if Lara collects all three in a level, and every level (but the final two) has three! The dragons are listed in the order they're obtained for easier measure. [NOTE: There's no reward for finding all the game's secrets.]

01) THE GREAT WALL REWARD: Grenade Launcher (6 Rounds), Small Medipack

SILVER	Towards the start, when Lara is climbing out of the cave with	
	the first tiger, she'll have to do a jump to some path overhang	
	to get near the high-up entrance. At this point, there is more	
	overhang along the wall and directly above the ledges she used	

| on the ascent. The item is there.

| JADE | After evading the first spikewall trap under the guardhouse,
 | | climb into a corridor with more covered spikes and scythe traps.
 | | Exit these and immediately pick up the dragon artifact, since it
 | | is in-between another spikewall trap and gives little leeway!

| GOLD | Before taking the zipline, it's possible to explore the lower
 | | cavern it crosses. First, hang off the edge and find a mossy
 | | ledge beneath, then shimmy along the ancient crack to another
 | | pull-up spot (leads to Flares). From here, there's a ladder that
 | | goes all the way down to the bottom. Approach the skeleton, kill
 | | the t-rex from the safety of the ladder passage, and scurry to
 | | the dinosaur's cave for the final artifact. [NOTE: Another t-rex
 | | shows up after this so make sure to get out of there!]

VENICE REWARD: 4x Auto Pistol Ammo

| SILVER | After opening the canal gate and boathouse door, drive into the
 | | former and light a flare -- there will be a small alcove right
 | | inside that has the item and more FLARES.

| GOLD | While driving the boat in the underground canals, there will be
 | | a dropoff point upon which it can't get back to the starting
 | | canal area. Disembark and find the artifact underwater.

| JADE | Near a dock with a clubthug, two rats, and a gate switch, there
 | | will be a skybridge overhead. Climb its ledge, shoot the window,
 | | and take the prize. [This can be gotten from the ramp on the
 | | other side but is the long way 'round.]

BARTOLI'S HIDEOUT REWARD: 4x Shotgun Shells

| SILVER | After opening a wooden door (canalside) and jumping into it, nix
 | | all the dogs/henchmen inside and search the empty room with the
 | | chandelier for a switch. This opens a door in the previous hall
 | | that leads to a balcony with a sniper (although he may have been
 | | killed previously). The dragon's there, plus Shotgun Shells!

| GOLD | Once the Library Key is gotten and the library chimney used as a
 | | passage to the flooded ground floor, look for a lever in the
 | | water that opens an adjacent door. One corner of the room is a
 | | flooded basement stairway that leads to the artifact down there.
 | | Note that Lara will be needing air soon after, so use the lever
 | | right near it (see with flare) and surface near the ballroom's
 | | fireplace.

| JADE | Toward the end of the level, Lara will have to use a detonator &
 | | blow up a building. This can be done immediately upon finding
 | | the detonator, although if Lara takes the brick wall parallel w/
 | | the canal, she can pull up to the 3F window of a house and find
 | | the dragon inside. This can't be obtained after blowing it up!!

OPERA HOUSE REWARD: 4x Uzi Clips (plus Uzis if Lara has none)

JADE	In the ventilation ducts connected to the opera dressing room, Lara will have to jump over some fans in order to reach a higher crate covering a door button. If Lara turns around from the apex and faces the fan path, there will be an even higher dark alcove that has the item. Careful, 'cause there's a dark fan there...
SILVER	After dropping into the water underneath the stage, explore the passage "behind" the entry point to find a small duct that leads to the item. Use a flare to locate it faster!
GOLD	Once the Relay Box is obtained under the stage and the elevator repaired with it, the lift will descend and Lara can climb the ladder in its shaft. At the top is the artifact in glass spikes, so be careful!

OFFSHORE RIG REWARD: Uzis, 2x Uzi Clips

GOLD	In the flooded hangar is a huge fan/propeller with the secret behind it. Pull the lever on the fan's left side, go down the passage on it's right -- this leads to a surfacing point after a while. There's a 2nd lever in the pool there, triggering a trap-door in the previous underwater corridor. From there, it's not too hard to get the item.
SILVER	After obtaining the Red Pass Card from a clubthug, the ladder found immediately after leads to the secret on the top deck.
JADE	In a room near the two drainage pits is a room with a trapdoor, leading down to a belowdecks area with some scubadivers/gunmen. The secret is visible on one of a "plinth" of a support strut.

DIVING AREA REWARD: 4x Uzi Clips

SILVER	After crossing the room with moving hooks & platforms, there'll be a wide slope that can drop Lara into a vat of acid. Scour the face for a hole, then align and slide to the secret within
JADE	Once the first Machine Chip is placed, the door it opens leads to a pool room with a thug and flamethrower-er. Look for a white machine that's really a door, sliding back to reveal a button as Lara approaches. It opens the artifact grate at the pool bottom.
GOLD	Toward the end of the level, when Lara is in the submarine dock (dry walkway rimming the area), proceed down a decline and enter a passage with waist-deep water. This leads to a room with two

guards and a beaten-up monk. Kill the guards but don't approach the monk -- that ends the level. The antechamber down there has the artifact.

40 FATHOMS REWARD: 4x Harpoons

SILVER | After draining the room full of crates and climbing up, the item will be visible in the cargo room below. Just watch out for the hidden trapdoor in the center.

JADE | In the room with flickering lights and pipes stretched across the floor, there's a switch right on the wall by the starting point. This opens a timed door straight down the hall and to the "left," which leads out into the seabed alongside the ship. The green artifact's in plain sight but is guarded by barracudas and a shark.

GOLD | After clearing the burner/corridor/switch puzzle, there'll be a swimming portion that'll test Lara's oxygen. She must swim to the top of a shaft, flip a switch, swim down to the bottom door she opened, flip that switch, and then swim all the way back up to a surfacing point. The gold dragon is in the lower switch's alcove.

WRECK OF THE MARIA DORIA REWARD: Grenade Launcher, 2x Grenades

SILVER | Toward the start of the level, Lara falls through feeble tiles and lands in an upside-down swimming pool area. The item's seen in a locked changing room stall. To obtain it, search the room adjacent for a ceiling hole -- it's behind overturned furniture. The passage there leads right to it.

JADE | Once the Rusty Key is collected and used in the compartments past the ballroom, there'll be a passage with breakable tiles over a burner with a barrel-rolling boobytrap immediately after. The ceiling passage the barrels came from is also boobytrapped with that same trap (evade by climbing up, jumping back down, & sideflipping) but contains the artifact.

GOLD | After triggering the bridge's trapdoor that lets Lara explore on the ship's underside (between seafloor and Maria Doria), swim straight across from the trapdoor to a rocky half-cave, keeping an eye out for a surfacing point high above. There's the item!

LIVING QUARTERS

SILVER | In the piston room, after lowering them from their initial state so Lara can climb on them, the silver dragon is in a wall alcove

| near the upper corridor platform. It's in plain sight if those
| directions sound confusing.

| GOLD | Once Lara floods the burner room and triggers the trapdoor in a
| pool beyond (with scubadiver and black lamprey eel), she will
| surface in a room with exposed ventilation ducts. These can be
| climbed on and give access to an upper corner corridor entrance.
| Beyond is a wrenchthug who comes from a dead-end passage where
| the gold dragon is visible; the problem is a glassy shard pit's
| underneath the drop-down point. So, from above, face the dragon
| pit, put Lara's back to the wall, and do a flatfoot jump toward
| it, holding Action button in midair to reduce the jump's arc and
| land just past the glassy spikes.

| JADE | A little past the gold dragon's location is a small pool with a
| barracuda. A breakable tile within this pool unleashes another
| barracuda, and the empty seabed grotto beyond contains the item.

THE DECK REWARD: 4x Grenades

| SILVER | In the cavern with the inflatable raft, look on the pool bottom
| for the artifact amongst seaweed.

| GOLD | On the Maria Doria's 3F deck, there will be a pool. Kill the
| barracuda and approach the false wall, which slides back to show
| a scubadiver inside. When he's dead, collect the artifact.

| JADE | The Maria Doria 2F deck is split in two and separated by the 3F
| deck; go to the side that did not have a shotgunner on it. Do
| a running jump to the weird rock/wood structure on 1F, then do a
| 2nd to the metal object en route to the stern-key building. The
| camera POV will change and the player can probably spot the item
| in a rockwall alcove. Do a running jump to the crack, shimmy a
| bit, and walk through the glassy spikes to find the item.

TIBETAN FOOTHILLS REWARD: 4x Uzi Clips

| SILVER | After reaching the hut with a snowmobile in front of it, look by
| the upper of the two locked gates -- it's right on its doorstep.

| JADE | Continue along past the narrow ice bridge cavern to the next, an
| outdoor area with two wide ramps. Get off the snowmobile and spy
| the artifact on a ledge to one side. This triggers 2x leopards!

| GOLD | In the cavern with the 2nd enemy snowmobiler, which is just past
| the hut area that had the Silver Dragon, continue to the next
| abyss. The artifact is at the very bottom and accessible via the
| ladder-like inner rim, but it's guarded by two waves of snowball
| traps, so beware!

BARKHANG MONASTERY REWARD: 4x M16 Clips

GOLD	In an upper niche behind the main hall's large Buddha statue
SILVER	2F: in the large pool room (near & connected to end of boobytrap hallway), swim to one of the corners and find it in an alcove. This can't be obtained if the pool was drained to get one of the Prayer Wheels.
JADE	In the boobytrapped hallway -- the one with burners, swinging halves of spikeballs, etc. -- it's at the end of a passage the 2nd rolling circular blade is in, past some clamper traps.

CATACOMBS OF THE TALION REWARD: 2x M16 Clips, 2x Grenades

SILVER	Right near the start of the level is a pit with slanted sides & a ladder coming out. On one side is a lateral crack; shimmy to a pull-up point and find the artifact by some Flares.
JADE	There's a bunch of pools Lara has access to after flipping the switch in the pitch-black room with incarcerated yetis. Near the 2nd pool's dry ledge is a ladder leading upwards. Lara has to backflip off, over a slanted portion, to the artifact. If she's short, she slides back to the ladder and can catch it.
GOLD	After encountering the room with two wooden pressure pads that lead to an L-shaped series of spikes, look in the corner for the wall portion that's bolder than the rest -- it's a ladder up to the artifact.

ICE PALACE

GOLD	In the first room with springboards, after Lara lowers the yeti cave, this gives access to the barred corridor alongside it. One of the wall blocks can be pulled out to reveal a room with the item inside. To obtain, align with the artifact pedestal and do a 'leap of faith' from the top of the pit, finding an invisible walkway that leads to and from.
SILVER	Once all the springboard room antics are done, and Lara finds a dark cave entrance with Bengal tigers, there are two ledges by the footpath. One ledge has a medipack, the other a door and the entrance to the relic.
JADE	After reaching the Ice Palace but before taking the Talion, look for a ladder at the room's base that stretches into the abyss on 3 sides. Jump to it, climb down, and use a flare to find a lever that opens the small building near the palace exterior. Inside's the item!

TEMPLE OF XIAN REWARD: 8x Uzi Clips (!!!)

GOLD	Toward the start of the level, there's a sliding portion where Lara is dumped into a waterfall and carried over. During said sliding portion, when dumped onto the watery slope, jump n' roll to make Lara descend backwards. Catch the edge when she drops, then shimmy to the item.
SILVER	The roof of the ornate building has a switch that opens a ladder grate near the waterfall's base -- it leads to a shaft with some ledges and a lava bottom. Descend using the ladders & shimmying. At the crack near the bottom of the room, shimmy to the item!
JADE	In the room with the first dragon statue encountered, a switch behind the statue will destroy the bridge. Jump along the pieces and the last one will be a springboard, vaulting Lara onto the boobytrapped, slanted end of the room. Avoid the boulder traps and look for a 2nd springboard at the bottom of a slope nearby. Ascend the ledges to the 3rd-from-highest, then slide down. The springboard launches Lara to a higher wooden walkway, and from there, the artifact's in plain view.

FLOATING ISLANDS REWARD: 8x Grenades

JADE	One of the Mystic Plaques is in a building's loft. In the lower vicinity around it is a climbable ledge with a cherry blossom tree which can be used to get onto the roof. The item's there!
SILVER	The gate that needs two Mystic Plaques opens into a garden. On the right side is a small, partially obscured tunnel that leads to the item.
GOLD	Toward the end of the level is a 3rd zipline that goes over a lava pit. Push the movable block under the zipline, then leap diagonally from where it [block] was to the rocky ledges near a wall of fire. At its farthest end, jump across the fiery pit and turn around, viewing a secret passage underneath where Lara just jumped from. This leads to the item on the building walkway near the floating garden/zipline area.

ENEMIES

[ENMS]

BENGAL TIGER

First Found: The Great Wall [#01]

These ferocious felines possess a lot of strength, although it's remarkably

silly how many pistol shots it takes to down one. Often times Lara will have a chance to snipe these instead of having to suffer their scratches & bites (although if she does, keep active with flips and such).

VULTURE

First Found: The Great Wall [#01]

Mostly appearing in outdoor areas (whereas bats appear inside primarily), the scavenger birds look for would-be carrion, such as Lara! They don't have any remarkable fortitude to speak of, but still take a few pistol shots to down just the same.

TARANTULA

First Found: The Great Wall [#01]

There's nothing remarkable about these low-health pests except they explode when defeated. They often appear in groups, though.

T-REX

First Found: The Great Wall [#01]

This behemoth from the Jurassic era possesses formidable might and takes a lot of hits to go down. Due to its huge size and small arms, it can only go in huge areas -- small passages and high ground give opportunities to kill without repercussion!

DOBERMAN PINSCHERS

First Found: Venice [#02]

These attack dogs have a strong bloodlust for Lara, but unfortunately, they have little health and even the pistols can take 'em down easily with a constant bead. If they appear in packs, though, things can get a bit hairy!

HENCHMAN

First Found: Venice [#02]

Any man who works for Bartoli is a henchman, generally -- these are normal grunts of little to no spectacular quality. Some use uzis, some swing clubs (what the heck?), some have double pistols and lots of life.

RATS

First Found: Venice [#02]

Wharf rats are small and basically the same as tarantulas, just without the cool explosions (those are traded for incessant squeaks). They take little effort to destroy.

SCUBADIVERS

First Found: Offshore Rig [#05]

These aquatic swimmers stay in the water and will attack defenseless Lara with their harpoon-guns. Lara can get one in the fifth level and fight back, but the best course of action is sniping them from a higher walkway, turning

the tables and capitalizing on their weakness (out-of-water fighting).

SHARKS / BARRACUDAS

First Found: 40 Fathoms [#07]

These fiesty fishies appear exclusively in the water (duh?). Great white sharks can make short work of Lara if they catch her off-guard, but move a bit slower than her; barracudas, on the other hand, are faster but do less damage (although they often appear with friends). Harpooning them is one way to retaliate, but finding a surfacing point and taking potshots gives its own type of enjoyment.

LAMPREY EELS

First Found: Wreck of the Maria Doria [#08]

These mustard-yellow eels appear toward the end, and are attached to nooks and crannies, lunging forward and baring their fangs when Lara swims by.

CONDORS / SNOW LEOPARDS

First Found: Tibetan Foothills [#11]

Condors, these magnificent birds of prey, act on "Bat AI" and often make noises to signal Lara of where they are, and don't take too many pistol shots to be downed. Find 'em in the open-air outdoors. Snow leopards are quick kitties and can attack Lara before she's even drawn her guns, but don't have much in the way of constitution -- keep a bead and backflip out of reach!

SNOWMOBILER

First Found: Tibetan Foothills [#11]

These vehicular vermin drive snowmobiles just like Lara, but instead of a turbo boost function, they have dual machine-guns! Unfortunately, that's a drawback -- they can only shoot from one direction and have little adjustment for height. Basically, find high ground and take potshots at their moronic invention!

BARKHANG MONKS

First Found: Barkhang Monastery [#12]

These docile monks will not harm Lara as long as she doesn't harm any of their brotherhood; however, if she lays a scratch on any monk, every other monk in the level will go aggressive on her behind. They use spears, so of course they're better at close-range fighting. A cool thing is that, if left to their own devices, they can often kill Bartoli henchmen and let Lara have the dropped items -- sweet! Definitely don't get on their bad side...

CROWS

First Found: Barkhang Monastery [#12]

They're like bats and condors, except they suck more. Yawn!

YETI

First Found: Catacombs of the Talion [#13]

These skulking, white ape-men hybrids are quite a nuisance, not so much due to their strength (of which they have plenty) but their annoying scream SFX.

REANIMATED STATUES

First Found: Floating Islands [#16]

These jade-colored warriors come in two types: inert statues that come to life by doing something (event, walking by, etc.) and those that are already 'alive' and can float in the air. They can inflict a lot of damage but will move very slowly, making them M16 or Uzi fodder.

CULTISTS

First Found: Floating Islands [#17]

Cultists appear only towards the end, and are like souped-up henchmen with hearts of stone. They don't use guns, rather dual throwing knives that they toss with enough speed that they can usually hit Lara at mid-range even if she's trying evasive maneuvers. They're hard enough that it takes 2 grenades to kill! Luckily, they usually leave great item pairs behind...

CHEATS

[CHTS]

There are only a few codes for this game and follow a pattern: sidestepping followed by counterclockwise spins (relative to whatever way Lara faces), and a backflip to confirm. Apparently there are no repercussions for doing these cheats, unlike, say, Tomb Raider: The Last Revelation. Have fun, cheaters!

R, L, R, L, B, F, Release R2, Spin x3, Backflip	All weapons obtained
L, R, L, U, D, Release R2, Spin x5, Backflip	Lara explodes!!!!!!!
L, R, L, U, D, Release R2, Spin x3, Backflip	Skip current level

V. FREQUENTLY ASKED QUESTIONS

[FAQZ]

[Q] - Why are your directions relative!?

[A] - Unlike some other TR games, this one has no compass. I've included some maps to make up for it, but it would've been nice to have a compass...

[Q] - In the Opera House, I placed the circuit board but the lever won't work!

[A] - If you tried the switch before inserting the item, it will be in the on position already. Try it twice and it should work.

[Q] - In the waterfall area of Temple of Xian, how do I get that medipack?

[A] - You can't. Apparently this is some kind of in-joke by the developers who did an 'unreachable' in the first game and others since. At least that's what I've heard...

10-25-08 -----+ Started walkthrough
 11-10-08 -----+ Finished walkthrough

For error corrections or chitchat, drop me a line -- I always have time for stuff like that.

THANKS TO...

- Sailor/Ceej, for putting up my junk
- Nic Holte, for always playin' TR games with me way back when
- The TR2 messageboard, for being good sports and chatting with me
- The readers, 'cause I wuv you
- Thin Lizzy's "Live and Dangerous" LP, the soundtrack to this guide

VII. LEGALITY

This document is intended for private home use ONLY, and may not be reproduced through electronic or commercial means without the expressed consent of the author (Patrick Summers). It cannot be hosted, edited, or distributed for profit, and may not be given away as an add-in/gift to bought items. All rights are reserved to respective parties, even those not explicitly stated herein. Those who find thos document on sites not listed below should e-mail the author (Shotgunnova). Thanks for reading, and thanks for respectin' FAQers.

ALLOWED SITES

DISALLOWED SITES

- Gametalk.com
- GameFAQs.com
- MyCheats.com
- Neoseeker.com
- GamesRadar.com
- Supercheats.com
- Honestgamers.com
- Chaptercheats.com
- Cavesofnarshe.com

- CheatCC.com

E-mail for permissions at:
 shotgunnova[.]gmail.c0m

DID YOU NEVER CALL? THESE
 RIVERS OF SUGGESTION ARE
 DRIVING ME AWAY

Document © Shotgunnova 1997-2008 (and countin'!!)
 Tomb Raider namesake © respective owners

E N D O F D O C U M E N T