



36) Inside Menkaure's Pyramid .....	WK36
37) The Mastabas .....	WK37
38) The Great Pyramid .....	WK38
39) Khufu's Queens Pyramids .....	WK39
40) Inside the Great Pyramid .....	WK40
41) Temple of Horus .....	WK41

IV. APPENDICES . . . . . APPN

Secrets .....	SCRT
Enemies .....	ENMS
Cheats .....	CHTS

V. FREQUENTLY ASKED QUESTIONS . . . . . FAQZ

VI. UPDATES & CONTRIBUTIONS . . . . . UPDT

VII. LEGALITY . . . . . LGLT

I. CONTROLS

[CNTR]

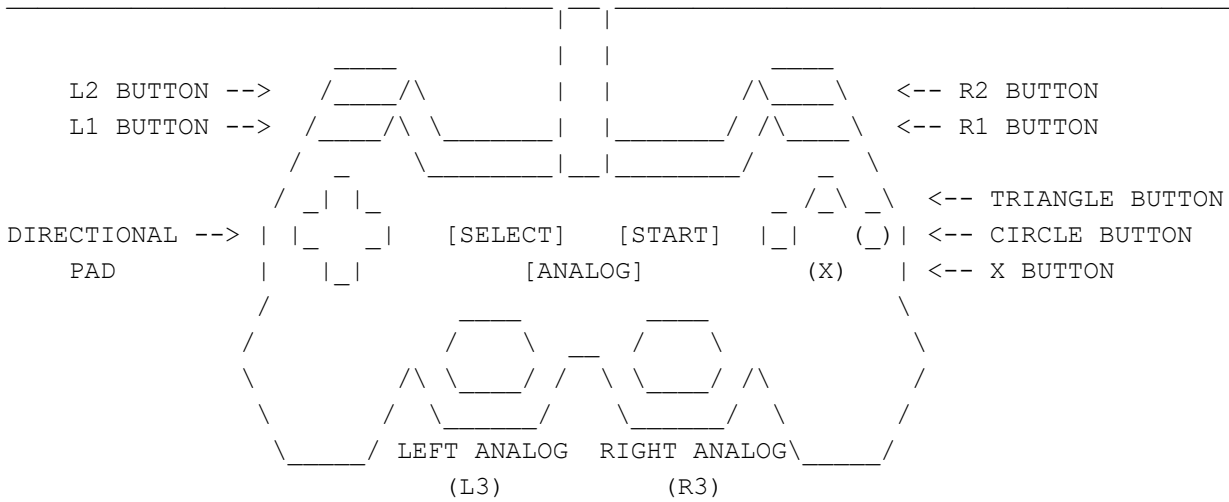

Analog function does work for this game, but since this is an "old-school" Tomb Raider game, it's full of precise movements and jumps which may really annoy someone used to analog sticks. Sorry, but if you play that way, things will be rather annoying.

NORMAL LARA CROFT CONTROLS

This section displays the game's controls. Only the functional buttons will be listed here.

L1 BUTTON

- Hold down (w/ D-pad) to swivel camera.

L2 BUTTON

- Crouch
- (w/ D-Pad) Crawl
- (w/ R2) Zoom in with binoculars or laser sight

L3 BUTTON

- Jump (Analog Mode Only)

#### R1 BUTTON

- Hold down (w/ L/R on D-Pad) to sidestep
- Hold down (w/ L/R on D-Pad) to take single step forward/back

#### R2 BUTTON

- Hold down and move with movement buttons (left analog/D-Pad) to move Lara while standing in place.
- (w/ L2) Zoom in with binoculars or laser sight

#### O BUTTON

- Roll and look opposite direction (can be used

#### SQUARE BUTTON

- Jump straight up
- (w/ L3 or D-Pad) Jump in a direction
- (w/ D-Pad Down) Backflip
- (w/ O button) Roll upon completing jump

#### X BUTTON

- Grab ledge (when applicable)
- Pick up object (when applicable)

#### START BUTTON

- Un/pause game
- Un/show Resume, Quit, Game Settings, Statistics Menu

#### SELECT BUTTON

- Bring up item menu / Save game / Load game
- (w/ R1) Throw flare

#### ANALOG BUTTON

- Toggle analog mode on/off (Dualshock Controller Only)

#### TRIANGLE BUTTON

- Take out currently-equipped gun / holster currently-equipped gun

#### LEFT ANALOG STICK

- Run / Walk / Take single step forward or back / sidestep

#### RIGHT ANALOG STICK

- Move camera to look around (ANALOG mode only)

---

---

#### VEHICLE CONTROLS

---

---

NOTE: Analog sticks can only be used if the mode is turned on. Digital controls (D-Pad) can only be used if the Analog mode is turned off.

#### LEFT ANALOG

- Turn left or right
- Pull back

#### D-PAD

- Turn left or right
- Pull Back

#### R2 BUTTON

- Nitro speed boost

#### X BUTTON

- Accelerate

#### SQUARE BUTTON

- Decelerate

#### O BUTTON

- Exit vehicle (when inert)

#### R1 BUTTON

---

---

## II. TACTICS

[TCTC]

---

---

### RUNNING AROUND

Use the Directional Pad or the left analog stick (if in Analog Mode) to direct Lara around the ruins. If you're using the D-Pad, simply press up to have her start sprinting; if in Analog mode, move the stick at a hard angle to make her run. Move the stick at a acute angle to have her walk. Press R2 while running to make a stamina bar appear -- Lara will run doubletime until it depletes. To do running dives, sprint and press Square.

### SIDESTEPPING

Sidestepping has many uses as you spelunk around the game. Use the D-Pad's L and R buttons in conjunction with R1 to take a step forward or backward. Use the Up and Down buttons in conjunction with R1 to take a single step forward or backward. When walking this slowly, Lara cannot fall of ledges like she could if she were running, so remember: safety first!

### ROLLING

Rolling is essential for when you're fleeing and need to get some shots off at attackers chasing you. By pressing the O button, you can roll in place and face the direction behind you; or, you can press O as a jump finishes to roll. Both will be immensely useful.

### JUMPING

What's a tomb raider without some ups? Jumping will be, no contest, the most important feat to get down. Use the Square button (or L3) to jump straight up. Use the D-Pad in conjunction with the Square button to jump in certain directions, and use the X button to grab ledges when jumping (if applicable). If you grab a ledge, you can press the L and R buttons on the D-pad to scoot one way or another.

Learning how to do running jumps will also help you, and in fact, you cannot complete the game without learning how to vault long distances. Lara will take about one-and-a-half steps from the time you press the jump button (while you are sprinting), so try to get as close to the ledge as possible when you jump off it.

### SWIMMING

Lara will encounter deep and shallow water in her adventures. In shallow water you can do all the normal functions as you can on land, but with slowed steps; when you're in deep water, press the L and R buttons (D-pad) to swim in those directions. Sidestep functions also work in the water, to a degree. Press Square to jump out of the water, and press X while doing so to grab any ledges that can be caught.

### LOCKING-ON

There are two functions in this field: manual and automatic. Manual lock-on means tap the L1 when an enemy's close to Lara to get it in her gun-sights. Tap L1 repeatedly to cycle through other enemies, if they're near. Automatic

lock-on, of course, requires no L1-tapping to make Lara recognize the enemy. You can still tap L1 to change targets, though.

## SHOOTING

Press Triangle to draw your weapon (or holster it, if it's already out). In automatic mode, Lara will shoot at the nearest enemy; in manual, you will have to tap L1 to make her recognize the enemy.

## CLIMBING THINGS

To climb walls, you can press Up + X to make her jump up and catch the ledge just out of reach. Hold down X to make her hold on; release to make her fall. You can sidle left and right with the D-pad while holding X down -- this is a key strategy to learn when the path is out of reach.

Eventually, you will come across poles that can be climbed. You can hold X by a pole to climb it, or run/jump onto one (hold X then, too). Hold down X to keep her clinging to the pole, and use the D-pad to make her shift left or right, or climb up or down. Lara will backflip off when you push the jump button, so make sure her back is to where you want to jump.

Ropes will come into play, too, and function the same way as poles do. R2 will make her rock back and forth on the rope, but unlike the pole, she will jump off towards her front, so make sure she's positioned right. Since building momentum on ropes is key most of the time, know that the lower she's sitting, the more she'll obtain.

Lara can encounter monkey bars (raised ladder put horizontally...remember from the playground...?) as well. Jump and press X to grab on, and press Up on the D-pad to advance across them. You can use the L/R buttons to spin around in this state. Release X to make Lara fall. [In the walkthrough, this is referred to as a notched ceiling, just so we're clear.]

## PUZZLE-SOLVING

- \*Press switch . . . . Use X button in front of switch
- \*Push/pull object . . Press X button in front of object, use U/D on D-pad to push or pull, respectively.

---

---

### 01) ANGKOR WAT

[WK01]

---

---

```

      |_____ | |
      |I|      8|_| | EXIT|      |_____ |
S     |_____ | | | |
      |H|_____ | | | | |v|_____ |
E----W | |      G | | EXIT|| | |_____ |
      | F ||>| |_____ | | 4D | | 3C | |B|
N     | | | |_____ | | 5| | | | | |
      | | | |_____ | | 6 | | | | | | |
      | 7|_| | | | | | | | E | | |
      |_____ | | | | | | | 2 |
      |_____ | | | |
| A: Floor Spike Trap      B: Wild Boar      | |A|_____

```

C: Manmade Waterfalls	D: Pool Room		____
E: Two Boars	F: Backpack		_  _
G: Wall Arrow Trap	H: Path of the Heretical		1
I: Route of the Virtuous			____

Unlike previous TR games, the 'beginner' levels are now mandatory and used to get newcomers their bearings. Young Lara will be accompanied by Werner von Croy, renowned archaeologist and self-important guru, for the next couple of levels, mind you.

After breaking into the priceless tomb, locate the first secret [1/70] in the form of a gold skull. There will be seven others to find also, and should you wonder the current tally, check the 'Statistics' tab on the in-game menu. Let Werner lead Lara along until he activates a spike trap, entering the second room. The tutorial deals with jumping the small gap, and another gold skull [2/70] is in the waist-high water.

Ahead, let Werner kill the small boar and enter the outdoor area with small waterfalls and pools. Get another gold skull [3/70] in the low area, under the eaves of a 'fall, before continuing with Werner's lecture on running jump n' grabs. Two longjumps later, mimic Werner as he finds a parallel ledge out of normal sight and shimmies to the higher entrance.

Beyond, the "soft fall" is learned: do a small jump backwards off the ledge, then catch the ledge, releasing it to reach the ground safely. Werner says it but doesn't demonstrate this time. Another skull is in the main pool [4/70] and also a watery tunnel that leads to a large medipack. Comply with the tour guide's demands and surface near the raised bridge, activating the lever so he can get across. On the pool room's other side, climb the ladder to another ladder, then descend in normal or drop-n'-catch fashion.

The next lesson is in clinging to the ceiling and crossing vines and meshed metal -- jump upward, hold X-button, and continue across, releasing when it's safe to drop. Back outside, let Werner eviscerate some boars and look for a fifth golden skull [5/70] in a SW corner. Werner leads the way through to a room with more suspicious spike holes -- avoid them and get the skull laying in part of the safe floor [6/70].

At a large circular door blocking the way, von Croy invites Lara to spelunk in one of the tiny floor 'vents'. The seventh [7/70] gold skull is found in a dead-end passage there, and in the larger room, a backpack next to the door lever. Back at Werner's location, he'll demonstrate how to sprint, which is then put to good use (in conjunction with rolling) in the area where wall holes shoot damaging darts.

Finally, this leads to a room where the path splits. Pick up the final skull [8/70] if you want to try the Path of the Heretical, which requires having found all of the level's skulls; the Route of the Virtuous is chosen if eight haven't been collected so far. The path chosen will be reflected in the next level as well, with the Virtuous path again being easier.

Upon reaching the passage's end, there will be a pool with a rope hanging over it, accessible by a hole hanging above normal height. Align Lara with the rope, and hold action in midair to grab; she'll have to catch it, gain momentum, and jump off to reach the lever's alcove. Note the only difference between the two paths in this level is that the Path of the Heretical's pool is bone-dry, and Lara is damaged if she falls -- save before attempting.

When all's said and done, drop down to Werner and put this level in the books!

SECRETS: 0 [8/70]

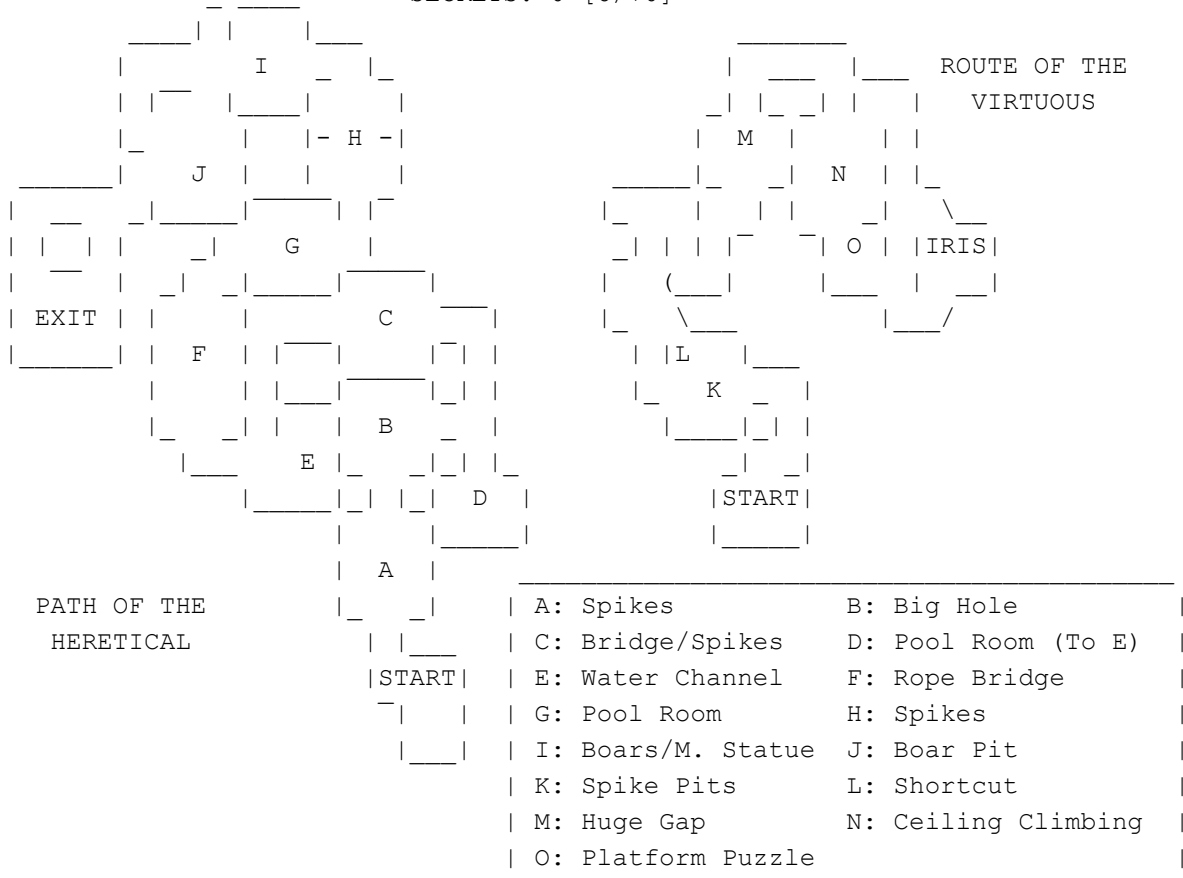

Depending on the route you took in the previous section of Angkor Wat, you will now face the ending run. If you found all the secrets, the race will be much harder and difficult -- Werner will be a speed demon and you will really have to work to win. If you found little to no secrets, the map is much less complex and contains less rooms for Lara to hang around in.

Now that you're so close to the prize, Werner will seem to be overcome by the grip of greed and "throw down the gauntlet" to you -- whoever's first to the Iris claims it as his or her own. On the count of three, the race between the educated professor and the exemplary student begins! Make sure to make use of the sprint button if you want to win, but either outcome makes no difference in outcome.

And because there is no incentive to win (besides personal reasons), I'll just do an overview of each path.

---



---

#### PATH OF THE HERETICAL

---



---

The harder of the two, this route is also the more dangerous. The perils are often spiketrap traps positioned off-camera or underneath sharp inclines, such as part "C" of the map where Lara may end up jumping over a slanted ledge and right into the pit. It's this instance where Lara must wait to slide, then jump to the next slide, then jump again! Very precipitous and scary!

In addition, Werner will close off parts of the path so that Lara, assuming





## THE EYE OF HORUS

---

---

Now in present-day Egypt, Lara has grown up and now carries guns -- obviously the dangers will have adjusted as well. The area where she starts has two packs of FLARES around, and near the first lit torch, a SHOTGUN. Follow with the torch-bearer until a LARGE MEDIPACK comes in sight...by a scorpion. From now on, always take a peek in those tiny pits since there may be more of 'em to neutralize. Further down the path, a mangy dog will attack the party -- also easy pickins.

Down near the crossroads, another LARGE MEDIPACK is on a mound. To get the area's first secret [9/70], move to the eastern part of the cavern walkway (the one not taken by the guide) and look for a block that can be climbed on. From there, angle the camera to find a niche with a SMALL MEDIPACK! This one is missable, mind you, so get it now; then, trail the guide.

Following small incline, the guide waits in a room with a locked gate. Enter the side passage and drop into the sandy room at the bottom -- an alcove reveals the level's 2nd [10/70] treasure, some SHOTGUN SHELLS. Watch out for scorpions that appear and grab the SMALL MEDIPACK on the way back up to the guide. Reach into the hole left of the locked door to fill up the lower secret room, then get the SMALL MEDIPACK and EYE PIECE before running back to the torch-carrier.

The next cavern has a rope suspended from a ceiling, which is used to get to the next secret, which is finding the alcove there [11/70]. However, there's a huge spiked roller that goes through the passage at regular intervals and it's instant game over if it eviscerates Lara! When it's clear, trek north a bit to where a SMALL MEDIPACK is by some climbable pillars. When it passes again, jump east off the highest pillar's point to grab the ledge in the (roughly) center of the room. The top of this area is safe, so get the FLARE sitting above. The east side is symmetrical to the first, so use it to jump to the red doorway. Three mangy dogs will be within, and beyond, a slide that deposits Lara near an UZI! Get it to return to the passage near the first secret room and backtrack, this time taking the west way at the rope area.

This leads to a sword trap (guide deactivates it if he reaches area first) and the second EYE PIECE. This is the first chance Lara has to combine items to make new ones, with the two pieces creating the EYE OF HORUS -- this goes in the northern slot in the rope room. Kill the mangy dogs that emerge and take a walk to...

---

---

## THE TIMELESS SANDS

---

---

...the Sphinx Room! Ignore your desire to explore it right now and follow the guide into a room full of unlit oil. Beyond, at the passage fork, enter the darker one with a SMALL MEDIPACK in a hole and come to another unlit oil room. Follow the only other passage upwards until Lara encounters a rope pulley above the ceiling tiles. Once admitted, the guard will light the oil and force Lara to do a puzzle! It makes sense to get a SHOTGUN in the passage before this room, which is near the reset mechanism -- get it later and the puzzle will have to be recompleted!

[ ][ ][ ][ ][ ][ ][ ][ ]      [X] = Pull cord for guard's gate  
[ ][ ][ ][ ][ ][ ][ ][ ]      [2] = Nearest brightened tile



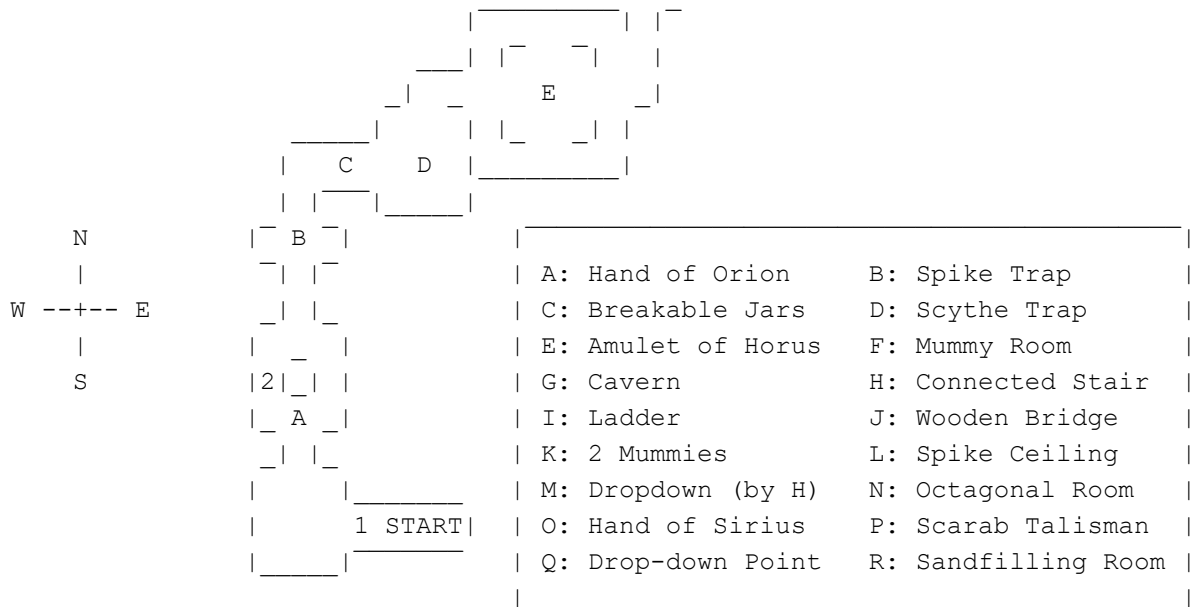

---



---

### THE AMULET OF HORUS

---



---

As soon as the level begins, SAVE! This is because there is a secret within the sliding portion: when the slope lights up a bit reddish, the ceiling'll expand and Lara can jump to a ledge with the level's first secret [14/70], a LARGE MEDIPACK. Back on the slippery slope, land near a door lever that will give access to another slope nearby. Slide down, obtain the HAND OF ORION in the middle and jump through the left passage that falls away, which will lead to the 2nd secret [15/70], SHOTGUN SHELLS. Down the passage, another spike trap will activate -- always keep an eye out for those star-shaped clusters that have spikes inside. I'll coin the phrase 'asterism spike trap' right now!

'Round the bend, some vases will be in the wall recesses -- these can be broken and should be, since one has a SMALL MEDIPACK within. Evade the next spike trap and jump into the hole beyond, which drops Lara in an alcove where the Hand of Orion can be stuck in the wall depression. Before doing so, drop down to the floor level and find a SMALL MEDIPACK in a corner.

With the Hand in the slot, this lowers all spikes on the walkways but starts the scythe trap. To reach the exit, I recommend jumping straight, sidejumping left, then repeating this once more to reach the safety of the passage. One can go the L-shaped path but it's longer; also, if you want the SHOTGUN SHELLS there, it's actually easier to get coming from the exit alcove! But, whatever.

Up the next area, a burial chamber is located. The SE corner has SHOTGUN SHELLS and the NW has a SMALL MEDIPACK. Ignore the center sarcophagus for the time being and enter the other passage, which is the "Mummy Room" on the map. Get the SMALL MEDIPACK and then drop down the NW corner, which has a passage that leads under the room to a secret [16/70], SHOTGUN SHELLS and a SMALL MEDIPACK. Return to the Seth's sarcophagus from before and move to its foot, where Lara will automatically steal the AMULET OF HORUS. Some...blood seems to spill out of the coffin, too -- spooky!

Actually, the blood has another effect: reviving the mummies in the room we just got the secret in. The corners are now flooded with red liquid, but it is safe to go in (but the previous secret is locked now). Push the center statue west off its base and onto the floor button of similar shape -- this opens a door behind the east mummy's sarcophagus. Get there by luring it out with the pistols -- don't waste any other ammo -- and entering when it's not looking. This corridor leads to a large cave.

---

---

## THE GOLDEN SERPENT

---

---

Enter the cavern proper to see some fancy dogs emerge from two sides -- they can be laid to rest with pistols rather easily. Pop a flare and locate the natural stairway on one side, which leads up to a wooden bridge and a ladder in a well-lit dead end. Before this though, there is a secret [17/70] to get! Once up the stairway, hug the southern wall and eventually there will be a tiny pit that opens up, leading to a LARGE MEDIPACK. It's easier to see by torchlight, naturally.

After, take the route that leads up the ladder, dropping Lara off by two breakable jars with SHOTGUN SHELLS and a SMALL MEDIPACK inside. Two mummies are nearby but won't activate until the GOLDEN SERPENT is stolen from its shiny pedestal. At this point, a higher northern alcove opens so get inside 'fore the mummies make friends. Slide down the slope and \_\_SPRINT\_\_ to the opposite corner, before the sand fills up and Lara becomes one with the spiked ceiling! Said corner has a climb-out point. Follow the path to a LARGE MEDIPACK perched near a floor hole, which will drop Lara down near Point 'H' on the map. Just make sure to land on the pedestal halfway down to avoid any unnecessary mishaps!

With the ladder part complete, now it's time to tackle the bridge (yes, you can avoid the lowest cavern path in the west for now). This leads to a couple fancy dogs sitting on the stairs, and beyond...

---

---

## THE OCTAGONAL ROOM

---

---

The room here is shaped like an octagon, and already we can see there's lots of spikes fully exposed here. An alcove within view has a LARGE MEDIPACK in it, and can be obtained with a bit of trickery: jump from the starting niche to the platform nearest it, despite how bad the camera is, and then a running jump up to it. By the way, this is a secret [18/70] and the last of the level so don't skip it!

As for the rest of the room, do a bit of platforming and get to the block with a wall receptacle -- it can't be used yet, but the ladder there leads up to a lever that will lower a ground-level gate on the northern side, whose ladder leads to a lever that rotates the entire flippin' room! The exit for the room closes here, so take an alcove back into the main octagonal room.

With most of the room out of reach now, drop through the floor opening to obtain the HAND OF SIRIUS. The passage leads back into the octagonal room, whose path leads up and under some spikes (crawl) before a flat-footed jump can land in another alcove. Save before jumping 'cause if Lara misses, she slides right into a razor-sharp spikebed! The passage's long ladder leads to a pull chain which switches the room's angle again, also awakening the mummy duo in the room.

The octagonal room's been though a lot but now it's back to its original shape. Use the Hand of Sirius on the wall indentation, which drops a rope from the ceiling. Save and swing to the alcove with the SCARAB TALISMAN which has no spike trap guarding like before. Move behind the pedestal and 86 the doggy duo who scamper along, then one more at the end of the next room.

---

---

## FINISHING THE CAVE

---

---

The passage leads back to the natural cavern in a one-way drop-down point. This time, take the ground-level western passage ("R" on map) until a sand-floored room leads to a dead end. Put the Golden Serpent and Scarab Talisman artifacts in the wall depressions to make the place fill with sand. The mummy comes to life, so lead it around in circles until the NW corner is accessible to jump out. This leads outside where some scenes end the level.

---

---

## 05) VALLEY OF THE KINGS

[WK05]

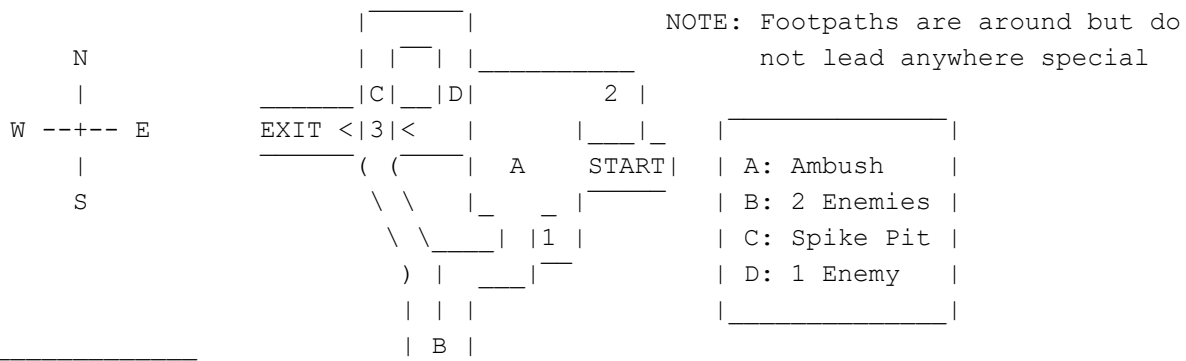

---

---

## OUTDOORS AMBUSH

---

---

For the first time, there are a bunch of human enemies to defeat. Save at the start and you'll find that most are hiding behind broken columns and other desert detritus -- pick them off one by one, using the shotgun if you are low on health. They're not that tough, and there are seven (7) in all to defeat. The 'trusty companion' will hide in one of the jeeps afterward.

The slain enemies drop a bunch of things -- SMALL MEDIPACK [2], UZI AMMO [3], LARGE MEDIPACK and IGNITION KEY -- so collect it all. The first secret on this level [19/70] is in the SE corner of the ambush site, in a dark alcove: it's two packs of SHOTGUN SHELLS and a SHOTGUN. The second secret [20/70] is less obvious to obtain. In the NW corner is a dark alcove. Climb onto the ledge that leads there and face east. Do a flat-footed jump to the semi-slanted red-colored ledge, which then leads onto the roof of the level's starting point. The bounty is two packs of SHOTGUN SHELLS, a SMALL MEDIPACK, and UZI AMMO. Get down by sliding on one of the olive-colored slopes.

---

---

## THE CAR CHASE

---

---

After collecting the Ignition Key from a corpse, it can be used on the jeep to initiate a car chase. Past the steep hill at the start, Lara can explore on foot (the enemy car waits around, oddly 'nough) but the jeep is necessary to end the level, so don't leave it too far behind. The enemy car will drop grenades directly behind its path of movement, so stay left/right of them to avoid any contact.

A little ways down the path, at a hill's crest, two enemies will fire their uzis upon the vehicle -- run them over! Through the cavernous tunnel, there will be a natural bridge overarching a spike pit, although the latter is hidden and Lara may drive into it. Kill the uziman on the bridge first and delay the pursuit enough to get the last secret [21/70] here. At the spike pit, do a backwards catch-n'-grab near the dirt ramp to see the inside wall is notched and climbable. Using this, descend and sidle to the thin opening under the ramp, which contains a SMALL MEDIPACK and GRENADE GUN SUPER AMMO. [NOTE: If you can't climb in through the opening to get the secret, this is a common problem. Let go of the ledge and quickly regrab it, then try: Lara should get a better foothold...or something. Either way, it definitely works!]

Climb back on the road and pursue the van again. There'll be more one more enemy before the van zig-zags over a higher-up canyon road, but past there, it's just a li'l ways to the level's finish. See, that wasn't so hard!

06) KV5

[WK06]

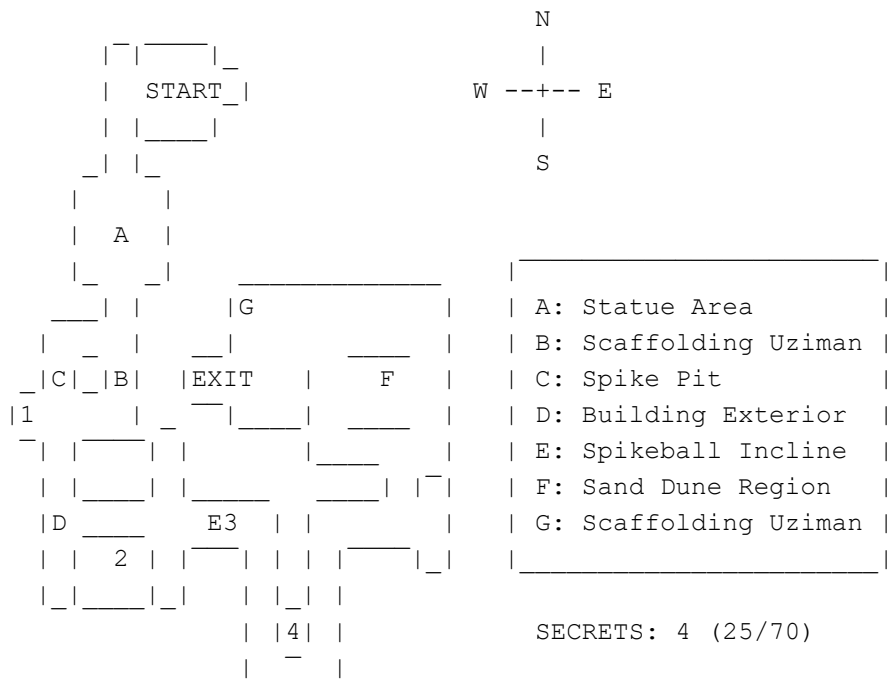

At the start, disembark and collect the two packs of WIDESHOT AMMO and a LARGE MEDIPACK sitting on the ground. Drive closer to the vehicle to see it's not really empty, and it starts back up, throwing a grenade for good measure. Let it progress through the first outdoor area -- full of statues but nothing else -- until the adjacent area has a uziman on scaffolding. Like all flimsy scaffolding, it can break if pushed -- crash through it! Lara can either go around or exit the vehicle to kill the goofball. The first secret [22/70] is in this area, near the south exit. Look for a small crawlspace in the rock with a LARGE MEDIPACK visible inside.

Nearby, there's a T-shaped intersection with a gate between buildings. One gunman is on scaffolding, so blaze through the foundation and knock him down to size. One of the fenced-in walkways contains SHOTGUN SHELLS, and down the other end, a gunman shows up on a climbing block. Kill him and drop down to ground level again for a secret [23/70] hiding in plain sight: SMALL MEDIPACK and a LARGE MEDIPACK.

Get back up on the walkway's middle section and stand on the climbing block the gunman was on. From there, it's barely enough clearance to jump "around"

the corner onto the highest part of the walkway roof. A LARGE MEDIPACK is in an alcove there, and after swinging across the road via the rope, locate the gate switch high up on the wall: jump-n'-grab it to deactivate.

Past the gate, on either side, are statues with tiny alcoves in between. Lara can get UZI CLIPS and a LARGE MEDIPACK inside (one on each side of road). The road itself leads up an incline where spikeballs roll downward, alternating sides -- just go around to avoid lame damage. A secret [24/70] is actually hidden in this ramp's ceiling. Make it through to the top and disembark, and look at the ceiling near the top. Face east and jump upwards, pulling into an alcove with GRENADE GUN NORMAL AMMO.

Further on, avoid the small spike pits and come to an L-shaped hole with a notched (black line) inner wall on one side. Climb down it and near the bottom, a small aperture that can be climbed into shows its WIDESHOT AMMO and CROSSBOW NORMAL AMMO. That's the level's last secret [25/70]! And, like the similar one in the previous level, to get inside, grab the rim, let go, and quickly re-grab -- otherwise, Lara can't pull herself up into the niche!

Back in the vehicle, follow the road down the slope and reunite with the van who's probably stopped to wait for the player. He'll enter an expansive area with sand dunes. Be careful of sand pits over the crests, and there'll be one scaffolding uziman that can be avoided for the most part. The van leads to a tunnel which marks the level's exit.

07) TEMPLE OF KARNAK

[WK07]

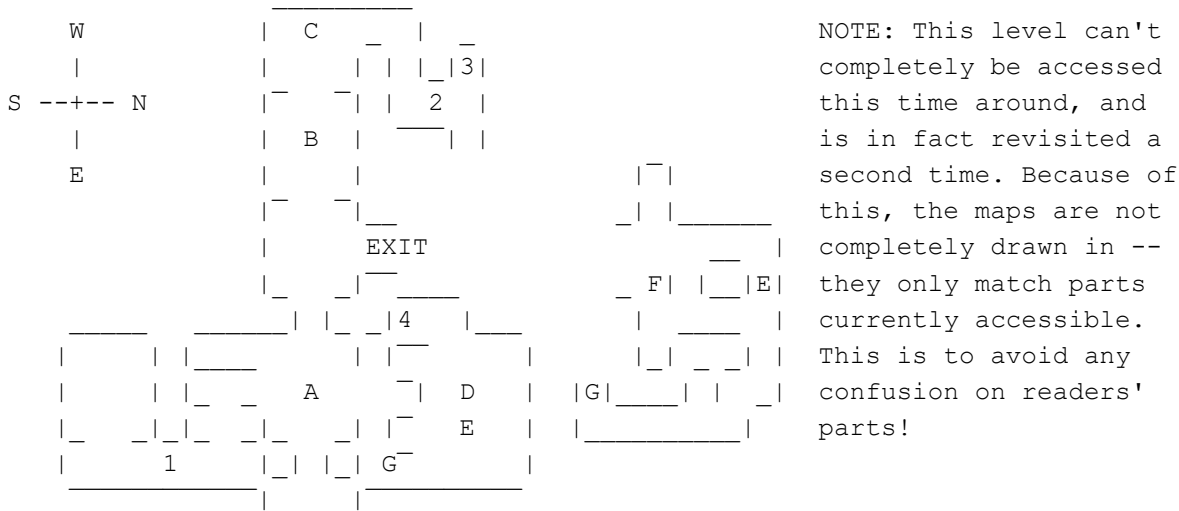

NOTE: This level can't completely be accessed this time around, and is in fact revisited a second time. Because of this, the maps are not completely drawn in -- they only match parts currently accessible. This is to avoid any confusion on readers' parts!

START	
A: Obelisk Plaza	B: Canopic Jar 1 Area
C: Underwater Tunnels	D: Dry Pool Room
E: To Lower Canals	F: Canals Proper
G: Connected Tunnel	

CANOPIC JAR 1

Once the vehicle is trashed, get out and travel west, using the chunky debris to vault over the wall. Down below, near the obelisk, kill some scorpions (these ones can poison Lara!) and take the SMALL MEDIPACK at the monument's plinth. To the south are some broken archways and such, now defunct and in a ruined state. Use debris to climb up a ways and see items scattered across their peaks: SMALL MEDIPAK, UZI AMMO, and WIDESHOT AMMO in an alcove. In the SE corner of this area is a small pit with a crawlspace, leading to the first

secret of the area [26/70]! Most of the items are within breakables, which ends up being SHOTGUN SHELLS, LARGE MEDIPACK, UZI AMMO, WIDESHOT AMMO, and FLARES. Return to the obelisk plaza again.

Before continuing, there is some WIDESHOT AMMO above the doorway to the west. There is a tiny pillar base and a sloped pillar near there, with the latter actually able to support Lara (while part makes her slide). Use the smaller portion to land far up the pillar to avoid sliding, then slowly step back and flatfoot jump to the shells. Sounds hard but it's easy since you can get a visual on the prize from higher points in the plaza.

Continue east through the first room and enter the hallway beyond -- Lara's attention automatically turns towards the ceiling. One of the blocks nearby can give access up to the ceiling walkways, so scurry up and claim SHOTGUN SHELLS and UZI AMMO on the far side. The two reddish 'doors' actually house niche mechanisms to unlock the gates up there. Trigger both and claim the SMALL MEDIPACK, SHOTGUN, and CANOPIC JAR 1. A scene shows a room yet unseen, so let's go check it out!

Before doing that, however, take a dive in the pool west of this area. Some FLARES are at the bottom of the first shaft, then locate the adjacent tunnel that leads to a greyish-blue door. Press action button when near enough and Lara opens it (requires no key, etc.). Swim the channel beyond until a small surface point is found -- this is a secret [27/70] of UZI AMMO and CROSSBOW NORMAL AMMO. Continue swimming north and at the bend, look west for a triangular crack in the wall. This is ANOTHER secret in very close proximity [28/70], WIDESHOT AMMO, CROSSBOW POISON AMMO, LARGE MEDIPACK, and UZI AMMO. The rest of the way is locked, so backtrack out of the pool entirely.

---

---

#### TO THE CANALS

---

---

Return to the obelisk plaza and go north this time, bounding over the rubble to the other side of the wall. Explore under the eaves of the building to find FLARES near a black scorpion, then jump over part of a sand dune outside to reach the rest of the building's interior, which is basically waterless pools with a SMALL MEDIPACK inside one. On the east side of the room, look for a high-up crawlspace that leads to the 4th secret [29/70], this time two packs of UZI AMMO and FLARES.

Back in the main room, notice that both pools have ringed ceilings that let Lara grab hold and monkey climb to the other end. Once on the other side, find the gray wall button in the middle -- this unlocks the door opposite the place. Trigger the niche mechanism that the door kept hidden, which'll drop an ornate bowl in the center of the room, leaving a hole that lets Lara get down to the underground canals area.

---

Soft-drop into the lower room, get the LARGE MEDIPACK and take either exit to the canalside walkways. There is a current going down the middle, but if Lara swims on either far side of the nearest canal, she won't be swept back to start. Use this tactic to get the two packs of SHOTGUN SHELLS hidden under the western walkway. That's all that can be done here for now.

Back at the ceremonial horn/bowl sculpture, look behind one of the throned statues to find an indentation for 'Canopic Jar 1'. This unlocks the gray door in the room sandwiched between "B" and "A" on the map. To get back up





side of the moat.

This room has a few holes, and one easier drop-down point to some water with a pole sticking out. Slide-and-jump to the first pole and get level with the second, on a small platform higher up. Position Lara's BACK to the pole as she will backflip to it, not some other acrobatic stunt. Once again backflip to a wall outcrop, which gives access to a crawlspace. This leads into the building surrounded by a moat! Pull the chain there to raise the gate on the west (outer) side of the building.

Backtrack to the pole room and get to a lower position where Lara can slide into the water. There's a SMALL MEDIPACK and FLARES in the pool there, which now connects to the moat's flooring. Get back on land, kill the crocs and bats who've come out to play, and swim to the building's interior again. A SMALL MEDIPACK and SHOTGUN SHELLS are on some of the alcove; after, take a plunge and look to the east for a lever hidden under a ledge, which removes a trapdoor nearby. Swim down into one of the holes and find a grayish door which can be opened by pressing Action in front, just like in the Temple of Karnak.

Save before attempting this next part, 'cause it's difficult due to camera angles and thin openings. Proceed along until a fork is encountered: pick the lower, thinner opening to find a surfacing pool by a LARGE MEDIPACK. Get some air and swim back to the fork, going the higher road now: it leads to a mirror room. The reflection hints that there's a hidden surfacing point but the pixelation in the ceiling is a telltale sign, too. The scummy surface does a good job of hiding it but it shouldn't be too hard to stumble into.

Alright, surface in the ceiling and obtain CANOPIC JAR 2 from the dead end, then the two packs of UZI AMMO there also. Stealing it opens a gate in the moat building's floor, so it's time to retrace our steps again (swimming back is easier on the out!).

---

```
| NOTE:
|
| We skipped the crawlspace back near the level's entrance since there's
| little reason to go there, although if you want, there are a few items to
| get at the obelisk and in the tunnel: FLARES, SHOTGUN SHELLS, SMALL
| MEDIPACK. Some are underwater, and watch out for black scorpions!
|
```

---

Once in said building, take the hole nearest the northern wall to be swept back to...

SECRETS: 4 but no new ones (29/70)

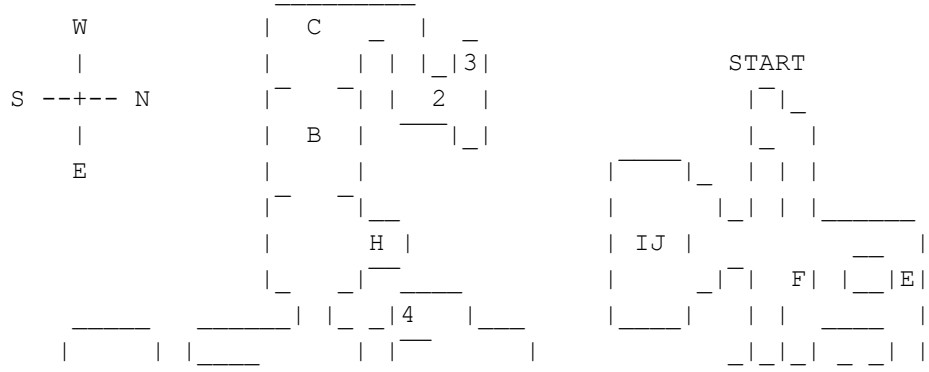



Locate the crawlspace from before and at the end, use the Hypostyle Key from the previous level to unlock. Two more ninja henchmen are inside, one of whom drops his UZI, and in the adjacent colorful room, another one. Get the SHOTGUN SHELLS sitting on a block. In the third large adjacent room, a final assassin is near some FLARES.

In the southernmost large room (the one with flares), a lit-up block gives enough height so Lara can jump-and-grab a ledge in the center, right under a notched ceiling. Use this to traverse to the west side of the third room, to a black switch affixed to the wall. This raises a black ceiling tile that is connected to the notched ceiling in the middle (colorful) room. Once Lara makes it across there, the music tone changes to hectic -- turn around and kill the ninja henchman swinging across the ceiling after her. Get UZI AMMO on the ledge there, and do a bit of climbing to get to the level's 3F, which is walking on TOP of the notched ceiling.

E. Waldron writes: "I found a large med pack that was not mentioned in your 'Last Revelation' guide. Looking at the map it would be off of 'F'. Moving from the crawlspace, head south through 1st big room, enter the second big room 'F' straight across, go along the wall until you get to a pile of rocks. Climb over the rocks to get in to a small room with a pillar in the middle. It's in back of the pillar. I hope that helps. Don't Jump up to the passageway above which leads to the third large room 'G'. The room is underneath the west passage from 'F' to 'G'."

Towards the center, look for a boulder perched on top of a column. This can be shot off, which will break a hole in the floor below. Drop down and get the would-be killer's WIDESHOT AMMO before lowering Lara into the boulder-made hole.

---

---

#### THE BOULDERHOLE

---

---

The pit made by the falling rock has one proper entrance and a small crawl-space with UZI AMMO inside. Take the former and the first passage to the west will have a giant crystal flanked by weird contraptions on three sides. Ignore this for now and locate the dead-end part of the corridor nearby...but is it really a dead-end? Inspect the ceiling to see part of a ladder is within jumping reach.

Upstairs is three spinnable cranks which will rotate the weird contraptions hanging from them below. Assuming North is "12:00", do the following:

NORTHERN CRANK: One spin clockwise  
WESTERN CRANK : Two spins clockwise  
SOUTHERN CRANK: One spin counterclockwise

With this done, return downstairs to the crystal/prism room and look for a chain to pull. If all contraptions are in order, electricity will destroy the prism and leave a SUN DISK behind. Stealing this priceless antique will trigger a trapdoor in the west floor, which leads to...



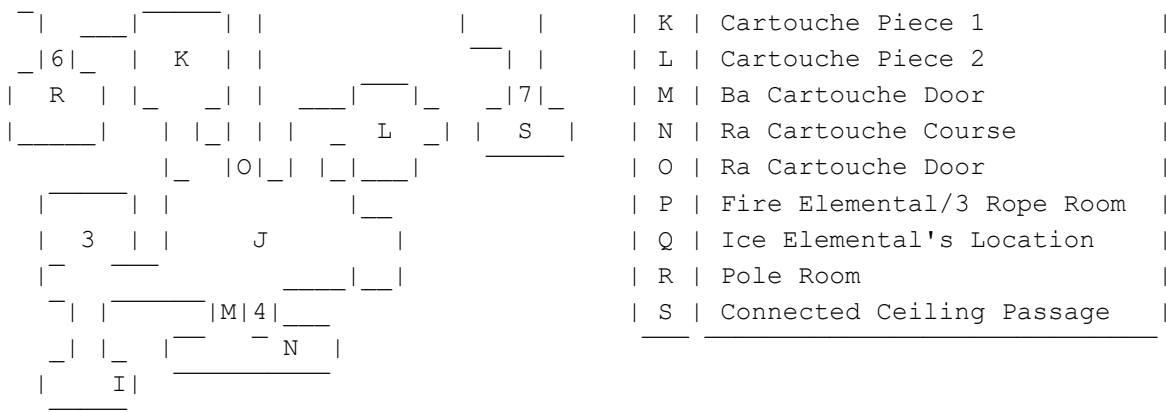

In the initial room, break the vases to obtain UZI AMMO and a LARGE MEDIPACK. Down the nearby slide, a scarab swarm will fill the floor and can damage Lara without any fear of repercussion -- grab onto the notched ceiling to avoid any mishaps, which leads to a slope near a pole. There are two floors below (B1, B2) accessible via this pole.

B1 has some breakable jars containing a SMALL MEDIPACK and a torch (not in inventory, just held) that can be lit by pressing Action near a torch. This can scare scarab off a bit. Jump down to B2 and press all mechanisms, one of which contains a SMALL MEDIKIT; the others make a door on B1 open. Lara can't activate switches with the torch, so drop it first and scramble back up and exit to the west.

There are three red doors here, but the southern one is the only that can be opened normally. Soft-drop down the hole to end up in the 'Senet Room', which was an ancient board game the Egyptians played. Lara will have to her hand at it, with the outcome depending on which way she goes.

Before that though, jump NW along the ledges (from the drop-in area) to see a black ladder carved on one side of the 2F. This leads to the level's first secret [31/70], WIDESHOT AMMO and a SMALL MEDIPACK. Drop back down to floor level and mosey east, using the wide ladder/corridor to find a room with lots of fire.

Drop down and kill the two fancy dogs and look for three blocks with firejets streaming out: the middle one never stops but the others alternate. Wait for the easternmost to stop blowing and trigger its mechanism, which shuts off the middle block's jet. Trigger the middle block's mechanism to make an odd block to the east lower. The remaining fire jet's niche contains a SMALL MEDIPACK, if y'want it.

Behind the block that was dropped is a pool and a six-flame mechanism thing, which is like this diagram below. There's a specific order to do it in, so save first 'case Lara lights up like a firework.

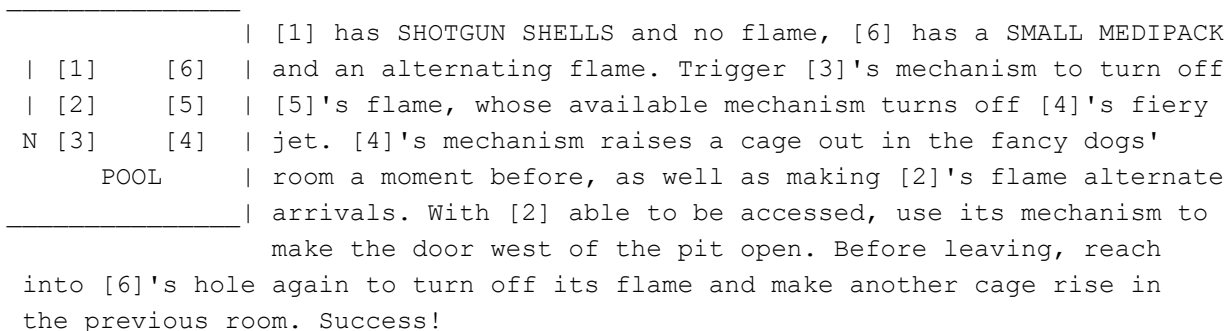

Use the ceiling's monkey bars to climb over the deep shaft (or backtracking by the pool), come into the area where two cages now let Lara have access to the upper parts. Climb onto a cage and jump to the ledge in the middle -- it

too has a flaming niche which snuffs out flames in a B1 room.

Before jumping down, there's a S-E-C-R-E-T [32/70] to get! The east side of that platform has a ladder etched in it. To get there, sideflip onto the slanted portion and grab the ladder, then shimmy around the corner until an alcove with WIDESHOT AMMO and a LARGE MEDIPACK comes into sight.

On the ground floor, use the lower ramp to obtain the now-fireless THE RULES OF SENET tablet, as well as opening a trapdoor above a ladder in the Senet room. Return to said room's west side, climb up the ladder, and backflip to the ledge where Senet can be played.

NOTE: If you win Senet, you miss out on five (5) secrets! That's incentive enough to try to lose, so save beforehand!

---

---

SENET OVERVIEW

---

---

The player can examine the rules by looking at...err, 'THE RULES OF SENET' plaque obtained a short while ago. The tenets are simple: the first person to move all of his/her pieces to the goal space wins.

GOAL Lara uses colored pieces, Semerkhet's spectre uses the golden pawns. When each player spins and gets a number

A-|\_| |\_| (all black = 6), a pawn is chosen and moved that much

|\_| |\_| in the direction. A free turn is obtained for landing

|\_| |\_| on an ankh tile or rolling a 6. The cool thing is that

A-|\_| |\_| landing on an opponent's tile sends their piece back to

|\_| |\_| its starting position, although this is true vice versa

|\_| |\_| as well. Also, if a piece makes it to the final ankh

|\_| |\_| and disappears, a free turn is also awarded! Oh, and

|\_| |\_| an exact roll is needed to get on the

..-- | | | | | | | | --. 'goal' ankh!

Lara's-|-- | | | | | | | | --|-Semerkhet's  
3 Pawns '-- | | | | | | | | --' Three Pawns  
\_ \_ \_ \_ \_

---

---

PATH: SENET WON

---

---

Defeating Semerkhet makes scaffolding rise on the senet board, which Lara can do running jumps across from the balcony where she initially fell in. That opposite balcony has two stairways that lead downward. At the bottom, an ankh door opens and spits out two fancy dogs -- kill 'em! Downstairs are two more dogs, and keep an eye out for jars that house UZI AMMO AND SHOTGUN SHELLS.

This leads to a small corridor where scarabs pour in; however, this time our girl can simply run to the opposite pole and backflip off at the top. The vases there have a LARGE MEDIPACK adjacent to a room with reflecting mirrors. Ignore the dog 'statues' for now and head up the ramp at the opposite end, which leads to a pole. Let two bats flutter down before making the ascent.

Backflip into one of the alcoves and find the one with a gray door that lifts when Lara approaches. The beams of light need to be blocked by the movable senet pieces, which have matching tiles underneath. Do the red one first, then move the other pawns down the center to their spots. You'll know the two similar ones are in the right place because a small scene below shows a light beam missing. When all are perfectly positioned, the sarcophagus

downstairs slides back and the two dog statues 'awaken'.

Slide back down the pole, dispatch the dogs, and use the crawlspace under the burial mound to reach a drop-down point. The gray exit on the wall you see is the exit used if senet was lost; otherwise, just approach the casket to finish the level!

---

---

PATH: SENET LOST

---

---

If Semerkhet's ghost wins, certain sections of the floor cave in like li'l trapdoors. First things first: save. Second things second: make sure to jump down the NWmost trapdoor! This gets easier access to the next secret [33/70] which Lara can jump to off the third ramp to grab a ledge. Use the pole to get down to breakable vases: SMALL MEDIPACK and WIDESHOT AMMO! Now climb back up to the ledge next to the ramps and save. This is because if Lara doesn't catch the next pole (or goes down backwards somehow), she'll end up as a big stain at the bottom of the shaft. Once she grabs the pole, get the SMALL MEDIPACK and UZI AMMO before descending, then kill a bat, man. =)

The room here has Lara placed a high corner, with two ropes hanging down and a bunch of walkway clutter. Jump to the ledge west of the pole and follow the passage to the "K" room with two fancy dogs inside. In a dead-end passage, drag the golden pedestal east and flip the lever, which smashes it with the two hammers, leaving a CARTOUCHE PIECE 1. Pocket it and return downstairs to the main chamber.

The easiest way to cross the rope course is to jump to the first, then to the ledge near a closed red door. Following, jump to a slanted portion and catch the ledge at the drop, losing no (or minimal) damage in the process. But guess what -- that closed red door actually houses a secret [34/70], a SMALL MEDIPACK and CROSSBOW EXPLOSIVE AMMO.

It's a huge hassle swinging like Tarzan, yo. Either way, climb up the ladder to the other pole -- it contains SHOTGUN SHELLS and CROSSBOW POISON AMMO, which is the pole shaft used if the player jumps down a different trapdoor in the senet room -- but instead of taking it up right now, drop down the west side to the odd-shaped mid-level platform and look for a crawlspace. Kill the bat outside first, though. The crawlspace leads to a room with another senet piece -- y'know the drill: push it as far as it will go and let it get smashed by hammers. It drops CARTOUCHE PIECE 2, which can be combined with the first to make...the BA CARTOUCHE! A door opens below.

Drop down and kill the two fancy dogs, break some vases for SMALL MEDIPACK and SHOTGUN SHELLS, and backtrack to the room with two ropes. Get Secret #34 here if not already and get down to the ground floor. The Ba Cartouche can be set in one of the golden wall indentations, which also unleashes two fancy hounds to give funerals to.

PAST THE BA CARTOUCHE DOOR

Okay, so we're halfway done. The passage beyond has another pawn but the path it can take has flames in it -- a no-no for Lara! Locate the black wall switch on the southern wall, save, and get ready for a timed portion! Do a running jump, flip the switch, and deactivate the floor fires in the senet piece's path. On the ground floor, quickly sprint to the other side and take a pole up to the piece. From there pull (the entire way) the piece towards the hammers, the push it the rest of the way for the last tile. The



odd music that plays here will stop after awhile, signalling that there's about 20-25 seconds of time left. The hammers' might reveals a RA CARTOUCHE, in full, that can now be used. Put this in the other golden indentation in the 2-rope room's ground floor.

#### PAST THE RA CARTOUCHE DOOR

Up the stairsets, a fiery monster (fire elemental) will appear and fly around the room, throwing heat projectiles at Lara. These do normal damage for the most part but she may catch on fire. Unless you want to run to the nearest water pool (which is in the Ra Cartouche course), the quickest way to negate it is to find the ice elemental switch and have 'em cancel each other out. This creature is found in the west part of the first room, up a ramp and down another. It's inside a cage and pulling the lever sets it free; it'll then kill its foe, yadda yadda yadda, threat neutralized. Two SMALL MEDIPACKS can be found in the Ice Elemental room, also.

Now it's time to get another secret [35/70]! Climb back to the Fire Elemental Room's opening and do a running jump to the first rope. Continue to jump n' swing to the alcove opposite the starting point, for GRENADE GUN NORMAL AMMO, UZI AMMO, and REVOLVER AMMO, which is the first sighting of the latter, I believe! Don't drop down, though or the rope-ing has to be redone. Jump back to the third in the chain and start swinging east, jumping to the next set of platforms.

Kill any bats and jump to the pole high up on the weird mishmash totem pole. Climb a bit until the next level of platforms -- backflip east to the one near a hanging wall switch. Kill two more bats and grab the switch, which'll raise a new ledge at the same height as that floor, although Lara will have to climb back up and kill a few more vampbats. Jump to that square ledge and find a torch in the wall mechanism. Unlike before, this is a must-have.

Toss it down to ground level, 'cause that's where we're heading. Return to the ground floor of the 3-rope (fire elemental) room and light the torch on the flaming pedestal. Once done, there are two unlit torches on either side of the pole room's entrance -- light 'em to hear a click. This opens up a trapdoor in the middle of the walkway! It leads to a secret [36/70] down a bunch of corridors, past a circular scythe trap (save before attempting to bypass) and in a dead-end room. It's WIDESHOT AMMO, LARGE MEDIPACK, FLARES, and GRENADE GUN FLASH AMMO. The room quickly fills with scarabs though, so get what y'came for and get outta Dodge!

#### EXITING THE LEVEL

Back in the 3-rope room, it's time to return to the pole from before...yes, this means backtracking and doing the course again. Lame, I know! Like before Lara must backflip to the ledge (near the black wall switch) and leap to the platform by the torch's niche. This time, Jump to the rest of the walkways lining the west side of the room; beyond, Lara can climb into the passage's ceiling. Look for a black wall switch above the entrance hole, which raises scaffolding so Lara can get to the level's exit after a bit of tunnel-travellin'. However, the level's final secret [37/70] is hidden in the ceiling therein: it's an UZI, CROSSBOW EXPLOSIVE AMMO, and a LARGE MEDIPACK!

Now, finish this level in style!

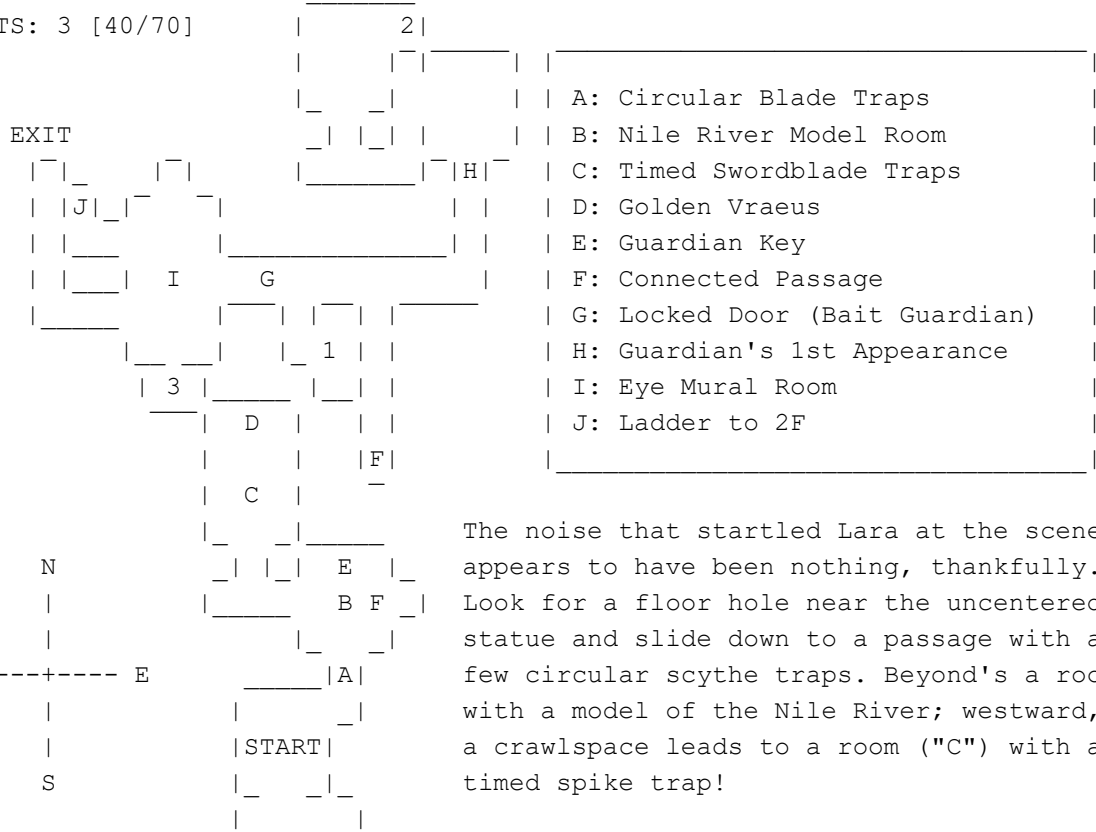

The noise that startled Lara at the scene appears to have been nothing, thankfully. Look for a floor hole near the uncentered statue and slide down to a passage with a few circular scythe traps. Beyond's a room with a model of the Nile River; westward, a crawlspace leads to a room ("C") with a timed spike trap!

...although you can't see the spikes, they're hidden under the walkway. If Lara isn't careful, they simply pull a one-eighty and chop her up with the cleaver-like blades. Keep pulling the wheel-like mechanism to temporarily open a door further down the path. Lara will have to make a break for it, and must keep moving to take advantage of the blades' delay times. There aren't any tips besides cut corners (when jumping) and DON'T SPRINT -- it's unneeded and will probably mess you up. The finish line prize is a GOLDEN VRAEUS idol from the pedestal. Just make sure to get in the habit of taking it from the back or at a diagonal angle, since this one's boobytrapped and some blades will emerge to attack the thief! Leave this room by sliding down to ground level and avoiding the dirt tiles, which are also boobytrapped with 4-blade slicers. The passage on the other side eventually leads back up to 2F, and from there, return to the model Nile room.

An indentation here is custom-fitted for the Golden Vraeus, so stick it in and watch the laser scene which opens up a model pyramid for a GUARDIAN KEY inside. It's used immediately on the east keyhole, which unlocks the trapdoor one foot away.

=====

THE GUARDIAN

=====

The trapdoor slides Laura into a lonely corridor far below. The ceiling here is notched, so Lara can grab hold in the eastern corner by a SMALL MEDIPACK. Ignore whatever's thumping behind the locked gates... (\*teeth chatter\*) Latch onto the ceiling and backtrack west, past the slide-in point to a crawlspace near a locked door. Let go and grab the ledge to find a room with fiery jets coming out of blocks...aww, not again! SHOTGUN SHELLS and CROSSBOW EXPLOSIVE AMMO are inside. That's a secret right there [38/70]!

As for the fiery mechanisms, the west one has WIDESHOT AMMO and a second try makes the east flame alternate blows. That one has UZI AMMO to reap, and a second try makes the last flame block alternate jets. There's a LARGE MEDIPACK

inside. The final niche flame extinguishes here but it'll just make scarabs pour in the room, so ignore it!

Back in the hallway, continue north until the source of what's rapping on the door appears: the Guardian of Semerkhet, a gigantic minotaur! It can't be killed by conventional weapons so don't waste ammo. It will charge at Lara and try to gore her with his horns; however, if she can dodge at the last second and make it hit a wall, it'll get stuck temporarily and she can go about her business, such as killing the bats that are flying around to annoy her.

To find a secret [39/70], enter the room the guardian came out of and follow its twisting passages to a dead-end room. There is a SMALL MEDIPACK and a torch in one of the wall holes -- keep it! The nearest lit torch is back by the minotaur's door lever, against the east wall. Light it and return to the dead end room the torch was found in, lighting the two torches on either side of the chamber. A secret wall opens and this is the aforementioned secret! The pedestals are boobytrapped, so take the SHOTGUN SHELLS, LARGE MEDIPACK, and CROSSBOW NORMAL AMMO carefully. Also, a spiked ball comes through the ceiling in the middle, so don't stray into it!

Return back to the guardian's hallway and make it chase Lara to the western reaches, which is sorta near where she slid into this area. There is a door here unlockable by any means, but by baiting the guardian into charging, it will bumrush the door and knock it down. It might be a good idea to save beforehand, so Lara can time her jump over the beastie. When it's clear of the door, sprint through.

#### BEATING THE GUARDIAN

This leads to the "Eye Symbol Room." As expected, start baiting the bull into goring the eye murals. Only two are necessary to begin, but do all three for good measure (keep in mind the camera angles here are bad!). Of the two doors that open, enter the one 'right' of the single eye symbol, which leads to a tiny area with a ladder. Climb up and go to the 2F's south side, where there is a open ceiling above the curved walkway. Climb up to the level's final secret [40/70]: SHOTGUN SHELLS, SMALL MEDIPACK, LARGE MEDIPACK. The pedestals aren't boobytrapped but the ceiling is, so watch it. Also, only one item can be taken; the others catch on fire!

Finally, look on the north side of the 2F walkway, which leads to items: SHOTGUN SHELLS, UZI CLIPS, and a SMALL MEDIPACK. Avoid the part of the ceiling that obviously holds a spikeball trap and maybe it won't appear at all!

Now, to end this 'boss battle', all three eye symbols have to be broken. If this was done previously on the ground floor, good; if not, do it from there or bait into attacking Lara while she stands/hangs on one of the pillars. Either way, when all three (3) are punctured, this opens a door in the west, parallel to the one that leads to the ladder. In fact, this one leads to a ladder, too...which ends the level. I guess we didn't beat the guardian after all...maybe there'll be a Round 2 later? HMMMMM?????

---

---

END			
_     _		A: Cargo Car	B: Tied-down Cargo 1 (Flat)
3		C: Boxcar 1	D: Boxcar 2

	START	E: Tied-down Cargo 2 (Tall)	F: Caboose
E	_ _	_____	_____
	A	SECRETS: 3 [43/70]	
	_ _		
		The level starts with Lara in a car with two levers: one opens a	
		door nearby and the other is broken. Do a diagonal jump to the	
		next car which happens to have its compartments full of cargo...	
	B	breakable cargo. A SMALL MEDIPACK and SHOTGUN SHELLS occupy the	
		first two, but the final crate's a waste of a bullet. However, an	
	_____	assassin appears so that bullet doesn't go to waste. Outside, the	
		exit leads to a tied-down cargo car with a green tarp. Two more	
	C	assassins on horseb-...err, jeepback appear to meddle in Lara's	
	_ _	affairs, too.	
	D 2	When they're disposed, continue working east and climb onto the	
	_____	adjacent car's roof. Two assassins appear, so quickly murder 'em	
		before they jump back inside and foul up the easy pickins. The	
	E	first boxcar has two packs of SHOTGUN SHELLS and a SMALL MEDIPACK,	
	_ _	plus an assassin hiding around the corner in a blindspot. The next	
		eastern car ("D") hasn't anything of worth right now, so skip it.	
	F	The next car is a tall bunch of cargo tied down with a green tarp.	
		To bypass this nuisance, hang over either edge of the car; shimmy	
	1	to the other side until Lara can pull up. The adjacent car, which	
	_____	happens to be the last one, has an assassin on the roof. After he	
		gets blown off the train, hang on the back edge and a door opens; catch the	
		lower crate lip and pull into the caboose's interior. Secret #1 [41/70] ends	
		up being REVOLVER AMMO, CROSSBOW NORMAL AMMO, and a LARGE MEDIPACK.	

Back on the caboose's roof, hang off the north side of the car until Lara can find another crate to grab, pulling into the other part of the boxcar. There is a bunch of crap here: 2x SHOTGUN SHELLS, a CROWBAR, and a SHOTGUN. A lever long since broken here can be activated with the crowbar! Doing this makes an assassin appear out of nowhere from a blindspot, though.

---



---

#### BACKTRACKING

---



---

Past the tall tarp ("E") car, another assassin is patrolling a boxcar's roof, and another shows his ugly face in the "D" car's eastern exit. When both are toast (plus the 1-2 that also assist), the "D" car can be robbed of its secret [42/70] treasure! Inside, there's a small dead-end with a funny-looking crate face. The crowbar pops it back to reveal a door, with GRENADE GUN SUPER AMMO, GRENADE GUN FLASH AMMO, and...a GRENADE GUN itself! Finally, a new weapon!

Continue the backtracking session, to the B/C cars, a.k.a. flatbed trailers. A jeep deposits two more assassins here, plus another in the "A" car. Finally reach the initial car with the broken lever. Use the crowbar on one of the crate sides to uncover the last secret [43/70], a SMALL MEDIPACK. Whee? Use the crowbar's lever to uncouple the rest of the train cars, then make it to the engineer's car and finish the level.



	E: Shooting Gallery / Token	F: Snakecharmer	
S	G: Coastal Ruins Proper	H: Get-to-Hill Pt.	
	I: Hilltop Building	J: To Catacombs	
	K: To Catacombs (Lower Entr.)	_____	
	_____		

Like Temple of Karnak/Hypostyle Hall/Sacred Lake before it, these next few levels are connected and can be revisited at leisure (usually). This can also be a confusing thing, so don't stray back unless you've forgotten something crucial to completion!

---



---

#### EGYPTIAN ADVENTURE

---



---

In the dark part of the entrance stairway, look for a SMALL MEDIPACK below. Enter the main street of town and notice to the south, a small passage that leads to a dead end. This is where the Egyptian Adventure exhibit Jean-Yves may have told Lara about (if she revisited him)...but it's closed for now. However, Lara can shoot the boards away if she so desires.

Let's get a new weapon first, shall we? SE of the starting point, after a bit of hallway-surfing, is another "locked" boarded-up door which leads to "D" on the map. There is another mirror here that catches Lara's attention -- it's booby-trapped with spikes and they only show up in the mirror. With that info on-hand, avoid the traps and claim the CROSSBOW, which also only appears in the mirror.

Once the item is safely in your hands, move toward the "E" room in the west. Save, combine the LaserSight from the Alexandria level with the Crossbow now obtained (first-person sniping with L1) and slide down. A ledge will raise and prevent Lara from plummeting into the spikes, and she'll have to complete a shooting gallery course to avoid that fate. There is a "bug" on this level where if Lara snipes the top-middle target with an explosive arrow (or grenade round I suppose), it blows all the targets up for an easy finish. Drop down below and collect the TOKEN for the trouble, then use the crawlspace to exit out.

With the Token in Lara's pretty pocket, it's time to do some more trickery to get that key in the cage before. The room right next to the Crossbow/Mirror puzzle contains a mechanized snakecharmer. Save, give it the token, and a big rope will stretch to the ceiling. Climb up and backflip off, then use the crowbar on a hook to obtain...the WALL HOOK, which can be combined with a BROKEN HANDLE sitting nearby to form a HOOK AND POLE device. Finally, use the Hook and Pole at point "C" on the map to obtain the GATE KEY. Well, Lara will still have to pick it up but y'get the idea.

That ends the exhibit portion; return to the street.

---



---

#### THE COASTAL RUINS

---



---

East of there are two arched doorways with one leading downstairs to a water pool. Get to the crawlspace therein which leads to a tall ladder, which leads outside of town: the coastal ruins area. This place will be revisited often as all the next levels of the Alexandria area connect to here in some way.

There are a few items to obtain before we do anything else:

- In the north part of this hilly region (without going back into town) is a current that extends east from the town walls. If Lara is there, she'll see some blue seaweed there, as well as having a tough time to get through due to the crappy angles. Either way, some GRENADE GUN NORMAL ROUNDS are to a bit lower & south of there, in an underwater alcove.
- Also near that area, except west more and on dry land (the white pillars), there is a high-up alcove that Lara can do a running jump to. If she falls it's basically right in front of the jetstream below, which is a nuisance, so save before attempting. The items are CROSSBOW EXPLOSIVE AMMO!

If you don't know how to get back on the hill after falling in the water, I have marked it on the map ("H") -- it's simply pulling up on a flat surface. Anyway, the small building farther up the hill is the main target to go to, now. There will be a skeleton walking the area (triggered from obtaining one of the ammo drops) that needs to be reburied before this, though. Normal weapons only knock them down; to destroy them, they need to be exploded or have their heads shot off with the lasersight (they won't attack after that).

Jump to the ledge with a pulley/boulder underneath it, and look for a higher ledge on the east side with WIDESHOT AMMO and a SMALL MEDIPACK. A door up on that same level is locked, but the Gate Key from the Egyptian Adventure area will unlock it.

18) CATACOMBS

[WK18]

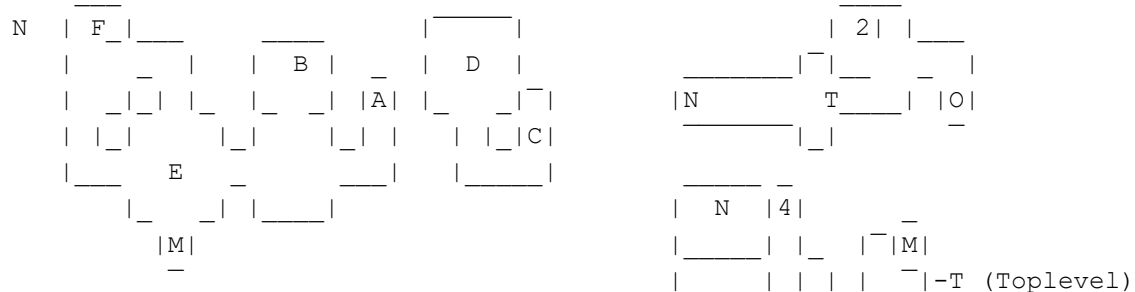

A: Connects to 'J' on Coastal Ruins Map	3
B: Movable Pillar	
C: Connects to 'K' on Coastal Ruins Map	
D: Pillar Support Room	
E: Pole Shaft (Connected Passage)	
F: Cross Statue	
G: "Elevator"	
H: 2-Rope Room	
I: Pool Room / 2 Levers / Ice Elemental	
J: Cross Statue	
K: 1-Rope Room	
L: Ladder to Midlevel	
M: Ladder to Toplevel	
N: Alcove with a Pole	W ----- E
O: To Coastal Ruins (Northern Building)	
T: Trident Location (x4)	SECRETS: 4 [48/70]
	S

NOTE: This level will requires minor backtracking, so this is a forewarning!

The first room inside has nothing, and the second has a brown movable pillar with a floor that depresses when Lara steps on it, i.e. the pillar can't be moved in full. This will need to be rectified! First press the 'face' button on the wall -- it raises a block in the room below -- and backtrack to...

---

---

#### THE COASTAL RUINS

---

---

In that small hilltop building, remember the pulley that holds a boulder over a pit? Jump down to the pit, trigger the boulder trap (jump under and flip out of the way) and use the crawlspace to find a crowbar-able door beyond. This actually leads back to the Catacombs, just in a lower manner.

---

---

#### THE CATACOMBS (LOWER)

---

---

Alright, so Lara is now in the lower Catacombs entrance. This leads to a single room with a movable pillar, and the brown block that was raised into the floor before. Move the pillar onto it, which steadies the unstable room above -- that's all. Backtrack to the upper portion of this dungeon again.

---

---

#### THE CATACOMBS (ABOVE)

---

---

With the brown pillar able to be moved, push it into the room right before, onto the tile with a face marking. Doing so unleashes an ice elemental that will go aggro on Lara (although it can't catch her on fire like the other pesky type!) so lead it through the west door that just opened. Ignore the pole shaft in the middle and take the north passage to where a weird cross-shaped statue is sitting by some pots. The ice elemental will disappear into this if Lara waits around a bit.

When the pest is gone, return to the pole shaft and slide down. At the end of the passage is a lever that works an false elevator -- the walls themselves actually slide up! This reveals two ropes hanging from the ceiling. Swing to the second rope and jump to the crawlspace to the west, which contains the first secret [45/70], a SHOTGUN, FLARES, and LARGE MEDIPACK. [NOTE: If you swung to the west alcove instead of the south, you'll find it just drops down to the passage below -- restart and do the secret!]

---

#### TRIDENTS 1 & 2

---

Anyway, the soft-drop from the secret alcove to the passage below, which runs parallel east-west. Up the stairs is a drop-down point to a ramp, although a jump-and-grab to the breakable vases results in WIDESHOT AMMO. Slide down to a pool with high walkways interspersed around. A skeleton jumps around, but a fun way to kill it is to use a shotgun blast and knock it into the water. When the pests are zapped, jump the higher ledges to get to the SW lever -- it makes some blocks extend so Lara can leapfrog across the southern wall to a vase hiding WIDESHOT AMMO. From that vase's platform, use the mesh ceiling to approach the 2nd lever. An ice elemental appears, so once the lever is pressed -- this makes other blocks extend on the east wall -- locate the cross statue in the SW underwater alcove. Finally, the middle raised platform duo can be used to reach the newly extended platforms, which let Lara exit



the room along the south wall. Clutch the ledge over the small canal and shimmy around to safety. Whew!

The path leads to a room with a single rope and a huge drop off, with pillars extending high upwards. Two skeletons will be around here, so it's in Lara's best interest to snipe/explode 'em. Get the WIDESHOT AMMO in the nearby vase and swing across to the ledge with an unactivated skeleton. A niche with more vases contains nothing, so ignore it. Instead, jump to the center pillar-top with a TRIDENT on a pedestal; stealing it activates the other skeleton. Save some explosive ammo and shotgun it off the ledge when it jumps over -- do this same tactic for the other skeleton, also. The NE corner of the room has a ladder on a pit's inner side, so climb down that way to WIDESHOT AMMO and CROSSBOW NORMAL AMMO. Ground-floor vases contain SHOTGUN SHELLS but nothing else. Climb back up the ladder, get the LARGE MEDIPACK on the western archway, and take the NW alcove ladder out of this gloomy chamber (2 skeletons chase!)

The next room has a skeleton guarding another TRIDENT piece. Climb the pole to the next-highest floor and get the CROSSBOW EXPLOSIVE AMMO. The next floor up has a passage ("M") that connects to the Catacombs' first pole shaft, now inhabited by a skeleton.

#### TRIDENT #3 & 4

Slide down the pole back to the room with two ropes ("H"), killing the creepy skeleton that rises from the earth. The northeast corner of the room has a ladder etched in, so a running jump-n'-catch will let Lara reach the bottom safely. Defeat the two skeletons and take the north ladder/passage out of this area.

In the next area, with huge ledges, Lara starts off on the ground floor. Ignore the west door (leads to skeleton) and take the east door, which has more dead ends & a skeleton, plus UZI AMMO. Return to the west door and one of the alleys leads to an alcove with vases, and a ladder hidden inside.

On the middle level, get the WIDESHOT AMMO. Along the south wall (middle) is a small alcove with a LARGE MEDIPACK, which sics a skeleton on Lara's tail. The SE alcove has more WIDESHOT AMMO and SHOTGUN SHELLS guarded by two skeletons on the path prior to this. Near that SE alcove, the NE alcove has a ladder that leads to the top level.

Nearby are some SHOTGUN SHELLS near a 3rd TRIDENT piece on a pedestal. As Lara nears the center long-shaped walkway and a skeleton rears its ugly mug. Catch the rope and cross straight, spawning a skeleton in the SE corner. Kill or ignore it, flatjumping to the structural pillar alcove with a pole visible inside. It leads up to a small ledge with an unactivated skeleton amidst some pots, plus a wide ladder. Since we'll have to come back down, destroy the skeleton right now and climb up. At the top, the passage leads to the final (4th) TRIDENT piece, which of course activates the skeletons here. What's the ladder behind the pedestal, you ask? It leads back to the Coastal Ruins area, at the north building (near the jetstream & seaweed). If Lara wants to climb up and crowbar the doors open, and kill skeletons, feel free, but there's no reason to leave completely just yet.

To get another secret [46/70], shoot all the small bone piles in the fourth Trident room (with crossbow) and a small trapdoor near the pedestal falls in, revealing CROSSBOW EXPLOSIVE AMMO. Doing this also opens a brown door in the SW corner of the previous large room's toplevel area, which is a 3rd secret [47/70]: CROSSBOW EXPLOSIVE AMMO, WIDESHOT AMMO, SHOTGUN SHELLS, and a LARGE MEDIPACK. Start softdropping down to the ground level passage where the room entrance/exit is, except this time go all the way north to the dead-end shaft.

The elevator will silently ascend at this time to the final secret [48/70] in the Catacombs, a LARGE MEDIPACK, WIDESHOT AMMO, and CROSSBOW EXPLOSIVE AMMO.

That's all for this level now, assuming you have all four (4) Tridents. Get back to the room with 2 ropes and exit to the west.

19) TEMPLE OF POSEIDON

[WK19]

```
|
| NOTE: This level requires all four Trident pieces from the previous level
| "Catacombs". Don't bother progressing until they're all obtained, 'kay?
|
```

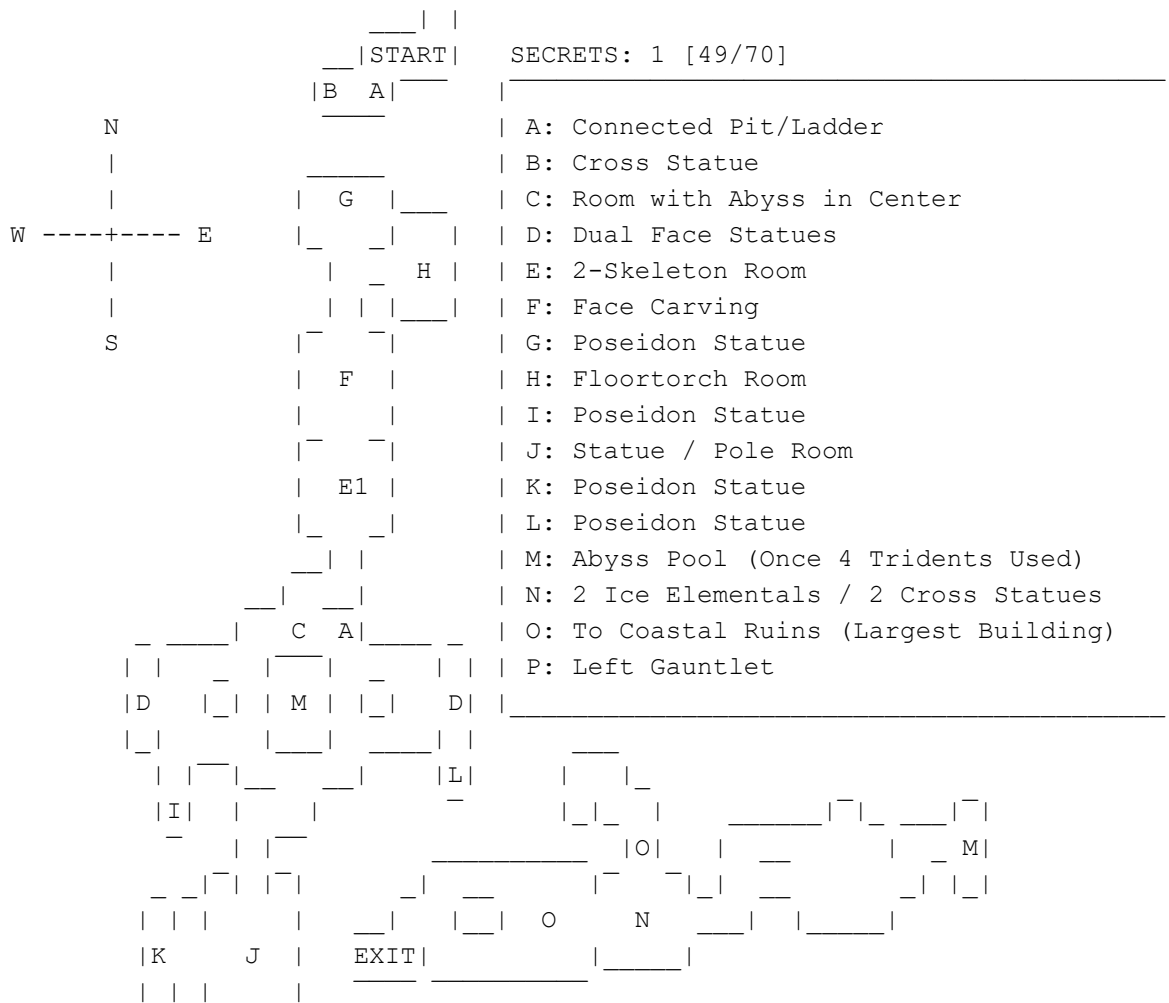

NOTE: The above map '-' may not fit with the compass directions but the largest portion does. They're schematically accurate, though. ^ \_\_\_\_\_ ^

FILLING THE ABYSS

Start the level and take note of the cross statue that can negate some ice elementals. The floor hole has a ladder one one side, leading into a chamber with a huge abyss (bottomless pit) in the middle and two face statues carved on either side of the area. Enter the northern passage and arrive at a room with 2 skeletons going for a pincer attack. Drop down to ground level and enter the SE crawlspace for secret [49/70], CROSSBOW NORMAL AMMO and a SMALL MEDIPACK. That's the only one in this level! Climb back up and trek north.

--- NOTE: The Tridents can be placed in any order ---

The next room with a gigantic face carving has a crawlspace 'neath it. The T-shaped junction beyond has UZI AMMO in a breakable jar, and the east room with floor torches has CROSSBOW NORMAL AMMO, SHOTGUN SHELLS, and WIDESHOT AMMO, plus two skeletons who want a fight. Carefully exit and enter the dead-end pool room nearby with a statue of Poseidon. Inspect its front and use one of the Tridents, which floods a portion of the area. Return to the room with a gigantic abyss.

This time, go east and find a crawlspace in a corner with a floortorch trap right below that needs to be circumvented (running jump-n'-grab works). The passage beyond leads to a SMALL MEDIPACK in a flimsy vase, a Posiedon statue that needs a Trident piece, and a few skeletons who want to ruin Lara's fun. If she catches on fire on the way back, there's always taking a dip in the statue's new stream!

Take the southern way now at the abyss' junction, leading to a face statue room with a pole leading upwards. On that higher floor, a vase leaves an offering of WIDESHOT AMMO and CROSSBOW NORMAL AMMO. Place another Trident in the Poseidon Statue to flood the portion in the pole room. Conserve ammo by ignoring the remaining skeleton and swim back to the abyss room.

For the final room, go to the east room. Around one of the corners near the dry fountain statue is a climbable part of the wall. At the very top, destroy the skeleton wannabe who surprises Lara from behind a wall and place the 4th Trident in its slot. Get the WIDESHOT AMMO in a corner and leave back down to the abyss.

---

---

#### LEAVING THE LEVEL

---

---

With all four Tridents used up, an ice elemental will now pester Lara. To get rid of it, use the cross statue that was near the level's start, up the very first ladder (which is camouflaged, or at least not as easy to find as a normal one). Alright, now the abyss is halfway filled with water, so Lara can jump in if she likes. Swim the small tunnel beyond to find a surfacing point with two exits, both west.

A skeleton appears when each stairway is topped for the first time, so blow up both and continue along. The next room with a floor fresco summons an ice elemental duo to annoy Lara; luckily both the breakable jars nearby contain cross statues that will un-summon 'em (although only one is needed). The face button nearby will trigger a trapdoor in the opposite alcove, which leads back to the Coastal Ruins level. I suggest taking that way just to crowbar the door open, then returning back to the ice elemental room.

The well-lit room right near there has a stone coffin with a LEFT GAUNTLET inside. Stealing this national treasure opens two side doors which connect to each other. The tunnel beyond has a crawlspace where the two paths meet, which leads to the level's exit.

---

---

#### 20) THE LOST LIBRARY

---

---

[WK20]

N			
		A: Main Hall (1F)	
		B: --.	

W -----+----- E	C:
	D:  -- These all mark doors on the first floor
	E:   (rather than items). This is for easier
S	F:   identification and direction.
	G: --'
	H: 2 Fire Elementals
	I: Pool Room (This place is revisited _a lot_)
	J: Planetarium
__ R __ S __ HARP __	K: 1st Appearance of Tinmen (Mechanical Men)
_____	L: Connected Passage (Pole)
_____ Z	M: Golden Star Location (x3)
_____	N: Swinging Chains
_____	O: Underwater Passage
_____	P: Horseman's Gem
T _ U   V	Q: 7-Serpent Fire Puzzle
_____	R: To Ceiling Library (AKA Long Way to 2F Rooms)
	S: --.
V  X	T:  - Also used for room identification
_____	U:
_____	V: --'
U  _____   T3 W	W: Lion Room
_____	X: Pharos Pillar Location
	Y: Music Scroll Location (Burn Planks @ 'U' Path)
	Z: Chain -- Opens Exit on 1F

SECRETS: 3 [52/70]

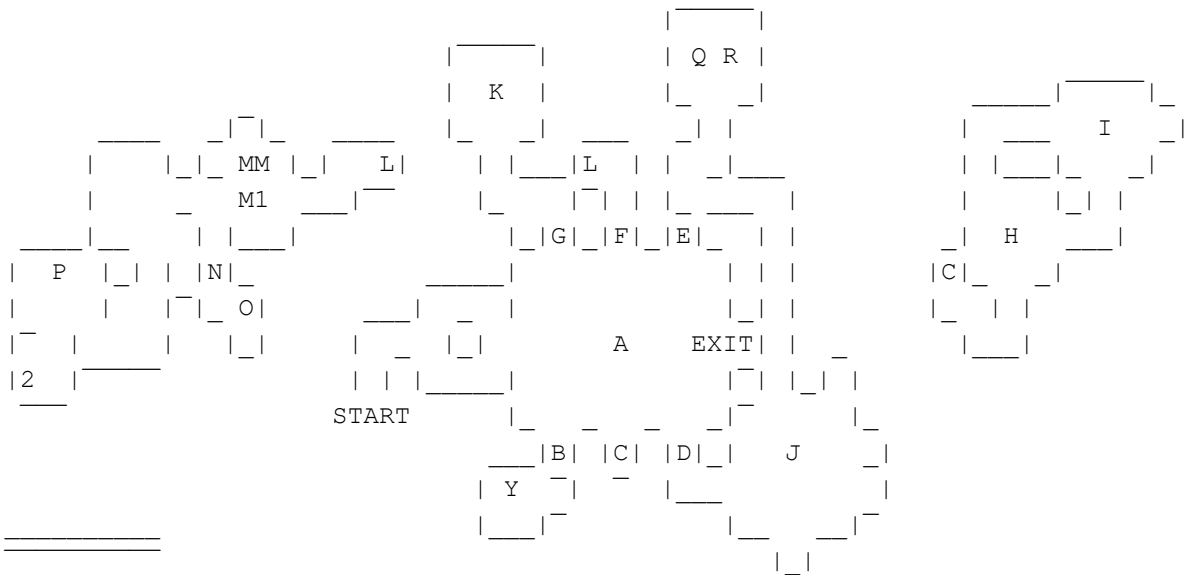

=====  
THE 1F SIX  
=====

The crawlspace leads to the level's main hall, which has six ground-floor (1F) doors and five balcony (2F) doors. The latter isn't accessible to begin with, so let's do the lower ones, all of which can open except the SW and NE spots. There's no particular order to do these in, either, mind you (although I've reorganized them in order of secrets obtained).

C DOOR

Save first. Downstairs, two fire elementals will rush at Lara so the player will have to do his/her best at evasive maneuvers. Take either side passage and make a dash for the pool; the pursuing ghoulies will be snuffed out when they touch the water. There's nothing else to do here now, but remember that the pools can be used for snuffing out future elementals. The scroll room's got a ladder leading to the balcony above, too.

## G DOOR

Inside, the first vase has a SMALL MEDIPACK inside. The room beyond has the first appearance of 'Tinmen,' mechanize menfolk with axes. They're impervious except when damaged from the front (blueish gem), and they'll grunt when they take damage. A shotgun gets the job done quicker. Anyway, the scroll here is a hologram and can't be picked up! Exit this antechamber.

## F DOOR

Take the pole down one floor and backflip to the SMALL MEDIPACK inside a vase. Watch out for the gears cogs rotating around the pole as they can quickly eat Lara's health! The next-lowest vases have SHOTGUN SHELLS and a LARGE MEDIPACK to reap. At the bottom, the path leads to another pole and then a chamber. Kill the tinman and pry the GOLDEN STAR out of its wall recepticle -- we'll need this for the 'D' Door. The gear in this room actually covers a pit that leads to a secret [50/70]: carefully back down the side with a ladder in it, and the pits keep getting lower and lower until the prize is found. FYI they are SMALL MEDIPACK, REVOLVER AMMO, UZI AMMO.

Back upstairs, look for a ladder on the south side of a pillar. This leads west to a pole; the room below has 2 mechanized tinmen to scrap. At the end is a long shaft that leads to a room where a tinman rides a horse. He can only be damaged when charging, and Lara doesn't take damage from the horse -- let her get pushed along by it and get some potshots from the safe axe distance! Eventually he'll be knocked off and fight Lara on foot, where she can finally get rid of him and claim the HORSEMAN'S GEM to herself. South of there is a secret [51/70] -- look for an odd gate up on the wall and use the LaserSight to snipe the pulley thing closest to the ceiling, opening the gate. The prize is a LARGE MEDIPACK, SHOTGUN SHELLS, and UZI AMMO. Return back upstairs, now.

The level right above (where the two tinmen were) has a gate that uses that Horseman's Gem to unlock. Pull the chain inside ONCE and it opens a gate underwater in the "M" room. Return there now, actually, taking the SW exit. To get past the swinging chains, simply wait for them to move away first. The room with a single large gear in it has a trapdoor covering an underwater passage. Continue until Lara is under the "M" room -- there's a surfacing point underneath a floor grid -- and look for a west-leading tunnel, through the gate opened by the Horseman's Gem. Pry open two more GOLDEN STARS here.

With all three obtained, Lara now has to exit back to the main hall of this dungeon. Yes, it's going to be a long trip, but it's not that hard (except for the pole gear part, which sucks no matter what).

## D DOOR

Just inside, look for a breakable jar that carries a SMALL MEDIPACK inside. This leads to a ground-floor planetarium with four other exits inside, plus a bunch of recepticles for the three Golden Stars obtained previously. These will open up four doors that contain globes. Lara must move these onto their circular spaces and match orbits of heavenly bodies...or something.

BLUE : Centermost Spot  
GRAY : Innermost orbit  
GREEN : 2nd-from-center  
PINK : 3rd-from-center  
YELLOW: Outermost orbit

You'll know they're done right because a ball of energy collects over the globes when in correctly placed (nothing happens if in wrong spot). After

all five are placed, electricity gathers and opens a northern door. Follow along, collecting the LARGE MEDIPACK from a vase, opening the "E" door from the inside.

#### E DOOR

This leads to Room "Q", a 7-point puzzle with a serpent statue/lever fixed at each one. To solve the puzzle, find the nearest statue upon entering and press it, then go counterclockwise to do all the rest. This makes blocks rise up and triggers a fire elemental -- to get rid of it, run back to the "C" Door passage and hide in the pool until it self-extinguishes! Return and climb up the block set, which leads to a library in the ceiling.

In the scroll antechamber, a SMALL MEDIPACK is in an upstairs vase, but the real reason for this area is that the library connects to the 2F of the main hallway!

---

---

#### THE 2F FIVE

---

---

So, after all that work, we're finally on the balcony again -- that makes 4 new doors left, all of which can be accessed now.

#### T DOOR

There is a slide here. Save first and go down normally, jumping to catch a ladder within the lion statue's mouth -- this leads to its top, which evades the boulder trap below as well. To complete the secret [52/70], do a running jump to the west wall's ledge, for CROSSBOW NORMAL AMMO and a LARGE MEDIPACK. Drop down and kill the tinman (although, after I missed the secret and killed him, then reloaded, he didn't show up again...). When he's dead, save and try to jump up the steep ramp -- this triggers a 2nd boulder, although it may actually bound over Lara's head. Jump to the wall switch alongside the ramp to raise a pillar upwards.

Once on top, forego jumping to the lion and instead aim for the south ledge. Pull up into the higher doorway and save when Lara's position is level with the statue's crest. Do a running jump and try to land on its flat mane rather than its facial features. Pull the chain at the top of its head to lower its jaw, then slide down its nose and catch-n'-grab it; from there, just drop and catch its jaw, crawling inside. Climb the pole in its, err, trachea. Save at the top.

Two gates raise here: one in a hallway, one in a room. Enter the room first and take the PHAROS PILLAR from the pedestal. If you do it out of order, the gate closes and Lara would have to go all the way through the T Door events again (or reload, ha). Open the trapdoor near the pillar to find it connects to the ground-floor "C" Room passage, the one with a big pool. This helps as a fire elemental appears in the hallway from the artifact room, not to mention it's helpful to have a quick go-between ladder to switch floors.

Either way, return to the Pharos Pillar room and enter the hallway that connects to the lion room's pole -- use the hallway gate this time. The only chamber to the side has a red torch on the ground and two burns Lara can work by stepping on the grate near 'em. Light the torch and continue to the floor that's made of wooden planks. Drop the torch there, setting fire to the wood and eventually caving it in.

| GLITCH ALERT: I've heard that people cannot get through the burned floor |  
| if they save the game after having left the area WITHOUT dropping down. |  
| This may not plague most people but the easiest remedy is to descend at |  
| first chance. |

In the room below, Lara looks at something on the ground -- a MUSIC SCROLL she can steal. Pick up the SHOTGUN SHELLS in the vase and exit, which leaves Lara on the ground floor "B Door" path on the map. However, we'll have to go back upstairs to use the scroll, so either:

- Enter the "C Door" path on the map and use the trapdoor ladder that leads to the Pharos Pillar room
- Enter the "E Door" path via the shortcut or planetarium and climb into the ceiling, doing this the hard way.

Either way, get onto that thurrrrr balcony, folks!

#### S DOOR

UZI CLIPS are hidden in the first vase, and the only room is a dead end with a harp there. Use the Music Scroll on the PEDESTAL to reveal a secret passage behind a bookshelf. This leads to a chain in the main room which opens the large double doors on the ground floor. Get down there in your preferred way and exit the level!

---

---

#### 21) HALL OF DEMETRIUS

[WK21]

---

---

SECRETS: 0 [52/70]

This is a small level, so I won't make a map.

Enter the main hall (1F) and traverse the south passage, which leads to a pedestal with a PHAROS KNOT inside. This is necessary to proceed later (this assumes you got the Pharos Pillar in The Lost Library, which is also needed). Return to the ground floor, take the opposite ramp to the balcony for a scene with Lara's nemesis.

When the scene's over, kill ninja assassins/henchmen/whatever and return to the balcony the cutscene took place on. Move the floor lantern there down the scrape marks (but not next to bookshelf) to reveal the secret bookcase path, which has a ramp leading back to...

---

---

#### THE COASTAL RUINS

---

---

SECRETS: 1 [53/70]

Surface after being dumped in the sink, which is somehow a secret [53/70], and pick up the BROKEN GLASSES from between the four pillars. A LARGE MEDIPACK and CROSSBOW POISON AMMO also sit silently nearby. Near the glasses' position is a hole in the ceiling, one side of which is notched like a ladder. This leads outside, where Lara's in the far west portion of the Coastal Ruins, in a part that wasn't even accessible before due to the crazy currents (these

have since become calm).

#####  
Boat writes: "Unlimited Secret in Coastal Ruins: I have found this glitch accidentally when I tried to find the way to open the another door in Hall of Demetrius. After searching every spot in this room and found nothing, I decided to get out of this room using the secret passage behind the bookshelf. After I exit this level and enter Coastal Ruins, I gained another secret that I had gotten it once (Note that I had entered Hall of Demetrius and exited the level with this secret passage once before I revisited this level to find the way to open that door). After that, I went through all the way to get back to Hall of Demetrius and exit with secret passage again. After entered Coastal Ruins, I gained the same secret again. I also checked the number of secrets I gained and found that the number also increased. I had tried this 3 times and get one secret for each time (result in 3 secrets at the same place). I didn't try it again but I think I will get more secrets if I try." [NOTE: This was done using the PC version]  
#####

To find the next level, swim out a bit and look for a long underwater tunnel in the south rockwall, before approaching the seaside ruins. This leads to a bunch of broken manmade debris in a cave, which one one side leads to a thin gap that ends the level.

---

---

22) PHAROS, TEMPLE OF ISIS

[WK22]

---

---

| NOTE: The Pharos Pillar and Pharos Knot, obtained from The Lost Library |  
| and Hall of Demitrius respectively, are needed for this level. If one's |  
| missed them, the surfacing point in the sunken temple has a crawlspace |  
| that leads back to the Coastal Ruins outdoor area, and backtracking can |  
| be done from there. |

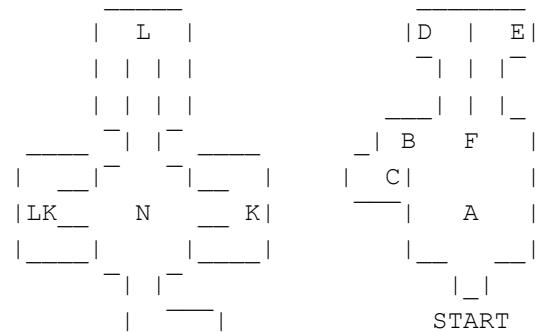

- 
- | A: Sunken Temple |
  - | B: Surface Point / Crawlspace Entrance |
  - | C: Exit to Coastal Ruins |
  - | D: Pharos Knot Recepticle |
  - | E: Pharos Pillar Recepticle |
  - | F: Door Opened by D & E |
  - | G: Lion Room |
  - | H: Crossroads #1 |
  - | I: Crossroads #2 |
  - | J: Cleopatra Statue Room |
  - | K: Broken Beetle |
  - | L: Black Beetle |

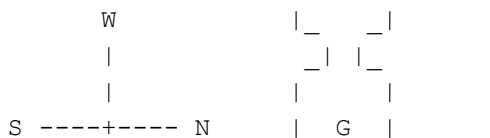



	_ _	M: Winding Key	
	_ _	N: Pyramid (Black Beetles go here)	
E	_ _	O: Exit to Cleopatra's Palaces level	
	F		
	-		

Currents blow Lara into the sunken temple and prevent her from exiting now, so might as well proceed. Spy a surfacing point high above and flock there for some oxygen refills, then climb onto dry land before the hammerhead tries to maul our girl. Kill the creature by luring it near the hole and it'll be time to swim around (rather than going in the crawlspace, which leads to a dark exit back to Coastal Ruins).

The sunken temple has two passages leading west, both leading to surfacing points where Lara can insert the Pharos Knot and Pharos Pillar. Placing both correctly opens doors ("F") at the bottom of the temple. Inside, Lara's lead to a well-lit room with a skeleton and a watery pit near two lion sculptures. This path leads to a three-door crossroads, although the south & west doors are dummies, leading to dead ends; go north instead.

This leads to another crossroads with a harpy, who can be taken down without too much effort (its wings shine when it's about to fire projectiles). Break the ornamental objects here for 3x SHOTGUN SHELLS, 3x WIDESHOT SHELLS, LARGE MEDIPACK, and a SMALL MEDIPACK.

The next part can be done in any order, although the north way should be left for last.

---



---

#### ROOM I - SOUTH STAIR

---



---

This leads to a room with a Cleopatra statue, and Lara gets locked in after a few feet. In the far corners of the room are two artifacts: the SE has a BLACK BEETLE and the SW has a useless BROKEN BEETLE. Taking either makes a scarab swarm flee the socket as well as raising a block giving access to the north or south alcoves in the room's middle (these are scarab-free at the highest point). Each alcove has a button to press; pressing both triggers a trapdoor in the room's center -- one side has a ladder on it.

In the room below, climb onto the nearest flat block. The object is to jump to the nearest slanted block, then to the next-nearest, then jump to safety. It can be a bit annoying to do so save beforehand, preferably before going down the trapdoor (hanging down the lip makes the scarabs fall below!). The prize for doing the jumping course -- which is similar to the one in St. Francis' Folly in the first Tomb Raider -- gives a WINDING KEY as a prize. Press the button there to release the door in the beetle room, letting Lara return to the stairway crossroads. Kill the skeleton there and hang a left to the west corridor.

---



---

#### ROOM I - WEST STAIR

---



---

The first room contains more breakable furniture, giving a bounty of a LARGE MEDIPACK, UZI AMMO, WIDESHOT AMMO, and SHOTGUN SHELLS. The adjacent room has a large pyramid (with receptacles for Black Beetles) and three slopes in all cardinal directions but east. They can be done in any order, and saving first is highly recommended.



---

---

## PHAROS, TEMPLE OF ISIS

---

---

With the final Black Beetle obtained, return to the previous level (check the map in section WK22 if needed) and locate the western room with the pyramid. This has four slots for said artifacts, and when all are placed correctly, it reveals a MECHANICAL SCARAB, which can be combined with the Winding Key to create the beautifully-named MECHANICAL SCARAB WITH KEY.

<p>  NOTE: The Mechanical Scarab with Key breaks after three uses, so be sure   you only use it as directed in the walkthrough! It IS possible to screw   oneself out of the level's only secret if used willy-nilly!</p>
---

Return to the palace area now.

---

---

## CLEOPATRA'S PALACES II

---

---

The fountain has an underwater passage that goes east to a wall mechanism -- this lowers part of the floor past the spike-trap passage. Stand on the tile with the scarab and pick the MECHANICAL SCARAB WITH KEY (manually from the menu), using it as a lab rat to trigger the spikes. Just make sure to pick it up again before going down the new path, which has two new ways to go. Go north first to a small room with a blade trap and a sarcophagus with a RIGHT GAUNTLET inside. Whew!

Stroll down the east corridor, kill the skeleton, trigger the spikes with the mechanical scarab. The antechamber here has WIDESHOT AMMO within a sarcophagus for some reason; just make sure to dodge the blade trap perched inside the doorway (and a skeleton) before leaving east.

This leads to a large chamber with many exits, but first a harpy must be put down. A coffin has a SMALL MEDIPACK inside; continue NE, ignoring the spot to the west (Point "H" on map). This leads to two passages and a artifact socket with SHOTGUN SHELLS near it.

NOTE: The Mechanical Scarab with Key breaks after three uses, so the player will have to make a choice on which way to go: north or west. The former'll lead to the level's only secret [54/70], 4x SHOTGUN SHELLS, WIDESHOT AMMO, SMALL MEDIPACK, and EXPLOSIVE CROSSBOW AMMO. The latter way lets Lara pull up into a northern alcove afterwards, although this way can be entered from another side so there is no reason to choose it! In fact, I'll cover that in the next paragraph.

Return to the room with the latest harpy and go to the west area. Look for a black wall switch that will trigger the double doors nearby, as well as make a block raise from the ground. Jump and catch the west wall, then shimmy to the alcove down the line -- this leads to CROSSBOW NORMAL AMMO in a breakable chest and a RIGHT GREAVE in the coffin past a blade trap. Return to the wall switch room and enter the L-shaped hole in the ground the fountain mechanism made before. Get the CROSSBOW EXPLOSIVE AMMO from the pit and see that Lara can now access the room with barred windows ("K"). A LARGE MEDIPACK and CROSSBOW EXPLOSIVE AMMO is inside, and the single sarcophagus contains the PHAROS KNOT we need...although it looks like a Pharos Pillar...

Either way, return to the room that leads to the secret and put the new item in the depression, leading to room "L". Take the SMALL MEDIPACK on the small ground-floor block and a wizard will make a golden replica of Lara on the other block. Okay, a wizard didn't do it this time, but it's still magical! Hop on the small block in the north, swing across to the next block. There's an alcove here from which Lara can grab the top lip of the notched ceiling and pull up, despite the camera POV's attempts to thwart that. Kill a harpy before the damage dealt to the statue is incurred by the real lass. Jump the gap, climb higher in a wall alcove, kill another harpy, then a skeleton when Lara reaches the tip top platform.

A breakable on the west side has a LARGE MEDIPACK, so get that first and save after. Notice there are two black switches attached to the pillars hanging from the ceiling in the west/east? Jump-n'-catch one, then fall a ways (lose health, sadly) near a released harpy; pulling a lever also opens one of the doors above. Secure the harpy nonsense and collect the ORNATE HANDLE and HATHOR EFFIGY items from the top-floor wall mechanisms, which then combine into the PORTAL GUARDIAN, which opens the remaining door up there.

This leads to the "O" Room, where Cleopatra's throne is. Get the UZI AMMO out of the breakable crate and approach the room. Lara can't resist sitting in the queen's chair and doing so triggers a trap with two Cleopatra Guardians. Although they both appear at the same time, they only attack one at a time -- kill the one that shoots projectiles (it took about 300 Uzi rounds for me) by staying out of its range or staying at mid-range and letting its projectiles miss completely. Repeat for the other, then take the BREAST PLATE and LEFT GREAVE from the containers nearby, opening trapdoors near the throne. That's how you exit the level! Enjoy the cutscenes.

NOTE: It's possible to take the items and run without killing the guardians but this isn't necessarily recommended except on self-imposed challenges.

---

---

24) CITY OF THE DEAD

[WK24]

A: Revolver (Dropped by Soldier)	I: Lever / Water Room	
B: 1st Automated Machinegun	J: Connected Path (Crawlspc)	
C: Garage / Motorcycle Ramp	K: Gate Switch	
D: East-alley Crawlspc	L: Grenade Gun	
E: Large Locked Gate	M: Gigantic Pit	
F: Rooftop Machineguns / Helipad	N: Draggable Soldier Corpse	
G: Bat-filled Portico	O: Building Husk	
H: Soldier's Corpse / LaserSight	P: Rooftop Access	

```

          |   |   |   |
          |   I   _ |   |   SECRETS: 1 [55/70]
          | _ _ | _ |
          | _ _ | _ | | Later on, another secret can be gained
W          |   _ _ H| by jumping over the pit at Point M,
|          _ _ | | | but the nitrous oxide/valve piece is
|          _ | | | | needed first!
|          | J - | | | | M
S -----+----- N  _ _ | _ _ | _ _ | _ _
|          | B | G | | _ | | _
|          | | | _ _ | _ | | | |
|          _ _ | | | _ _ C _ | | L|
E          | A  J| _ _ | _ _ | | _
```

```

|__K |^| O P| _____ | |
/ | ^|_ _ |^| _____ | | F |
Start ^| _____ | _____ D| N | _____ |
| _____ | E |
_____ | | - Exit

```

(To Chambers of Talun)

---



---

STREET LEVEL

---



---

This first level of the Cairo 'block' has a bunch of interconnected areas as those preceding it, and I've tried to take the most efficient route through. There might be some slipups here or there, but there shouldn't be too much (useless) backtracking. The motorcycle is also drivable right now, but Lara should clear the way first before bringing it up to speed (in my opinion...)

Lara starts the level on the street near the city gate, and two soldiers to south will fire on her. These guys are tougher than normal grunts, but can't stop bullets like previous assassins. The one nearest the street drops a REVOLVER! Like the crossbow, this can be paired with the LaserSight for more high-accuracy killing...although it has such little ammo (I got as many drops as I could the entire game and still only had 30 rounds!) that it should be saved for when it's required. Surprisingly, that's in about two seconds: up the street is an automated machine gun that can only be destroyed by shooting its weird canister at the back with the scoped revolver. A soldier is around here too, and he uses grenade rounds -- watch out!

Around the corner, kill the next soldier hiding behind a slanted ledge's cover then two more up the street near the garage area -- one leaves SHOTGUN SHELLS behind. Ignore the east alley and north street for a moment and jump the motorcycle NW off the sandhill to land by the fenced-off portion of the garage ledge, which makes it fall through. A SMALL MEDIPACK is inside, and leaving is possible by jumping through the garage door. But, for now, disembark to the red-glowing passage and fall down into the water, surfacing near a bat-filled portico. Get the FLARES and WIDESHOT AMMO here, and slide west (one-way) into the alley.

There, by a soldier's corpse is a LASERSIGHT in case it was missed way back in Alexandria. Upstairs, there will be an uncrossable watery pit with a lever on the other side. Nothing can be done here, although if Lara falls in, she can take an underwater channel and be dropped back in the soldier's corpse area. Speaking of which, in that very location, the NW corner has an upper ledge -- shimmy to a pull-up point, face the south alcove, and snipe the rotating blue ball (not the jar which releases locusts, although if you tried to blow up the corpse below like me, this also releases them). Ice elementals come out of the blue orb and these can be ditched by jumping in the water room up the stairs. Return back to that upstairs room and the water will have been frozen -- eureka! The lever opens the south door in the corpse room.

Therein, one of the doors can be crowbarred open to reveal the level's only obtainable secret (until later) [55/70], a LARGE MEDIPACK. A SMALL MEDIPACK is in one of the well-lit room's dead ends, too. To exit, climb the blue-glow path near the secret's door which leads back to the level's very beginning. But don't just jump out -- hang on the ledge, shimmy to a pull-up space, and do a running jump-n'-grab south to a black wall switch. This opens the nearby iron gate which gives us better motorcycle access. Kill the grenade-gunner soldier nearby at this point (who drops a SMALL MEDIPACK) also.

Backtrack to the motorcycle, jump out of the garage door, and proceed north to the building where two rooftop machineguns are. Get out of their line of fire, go west, and find the building doorstep with a GRENADE GUN and SMALL

MEDIPACK inside. Further west are two more soldiers and a gigantic pit that even the bike can't hop yet (we need nitro first); ignore this for now.

The building opposite the rooftop machinegun nest has an enterable door; a soldier corpse is sitting on a grate from below, which is why I had you ignore the east-alley crawlspace. Drag him off the hatch, then leave this building and circle around to said east-alley crawlspace, which we'll now be able to use in full. Pull the lever down there to flip the grate up, then climb up and enter the crawlspace near the corpse. The 2nd lever opens a roof trapdoor, but not in this building.

Drive the motorcycle to the level's beginning, and drive through the gate Lara opened earlier. This building husk has a bunch of ramps lining its interior, and actually can lead Lara right near the east-alley crawlspace from before (although we don't need to). Kill the bottom-level soldier and get the CROSSBOW POISON AMMO from the crawlspace near him. Ride the bike up to its top level and use the small kicker ramp, leaping the pit and into the opposite alcove, which actually is another path to take.

Near the first ramp leading up, look for a niche with a lever that raises a block in the stairway portion, near ground level on the north side. This path leads up to the rooftops.

---

---

## ROOFTOPS

---

---

The first jump is to the roof that the draggable soldier corpse was in. Jump behind the automated turret. Ignore it (it's broken) but take REVOLVER AMMO right by it. The reddish-color door will only be open if Lara triggered the lever inside this very building before (up the 2nd crawlspace). This leads to the other half of the roof, the one that can be fired upon by the turrets across the street. If you didn't snipe them from street-level, shoot the heli-copter in between them and they'll both be taken out en masse. Don't do as I did the first time, trying to jump between the buildings and get behind 'em -- they just use their flamethrower extension!

Jump to their position when they're kaput, then over the small pit to a lever that activates that opens the "E" gate we've passed by so many times before. A SMALL MEDIPACK is near here, too. Get down your preferred way and take the "E" gate via the motorcycle to end this level...for now.

---

---

## 25) CHAMBERS OF TALUN

---

---

[WK25]

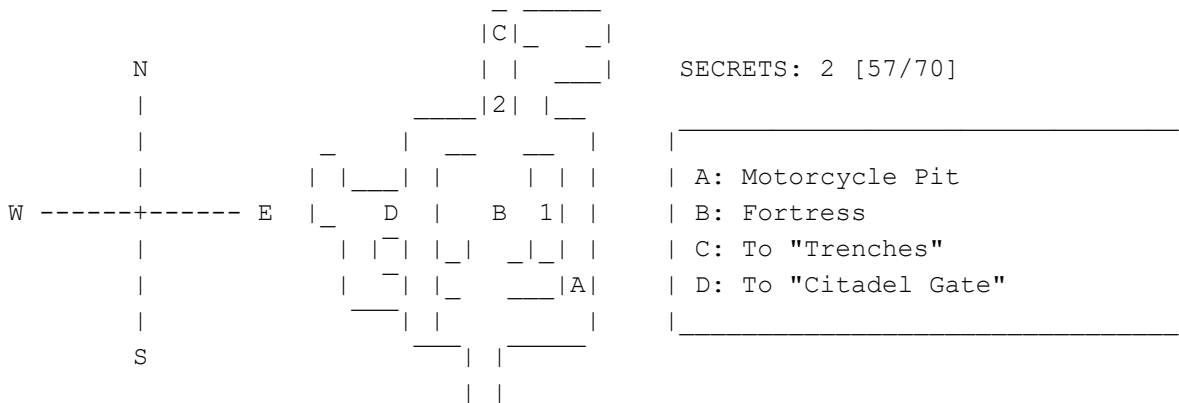

START

Start the level and kill the guard at the lower street, either by shotgunning him in the cranium or an old-fashioned hit-n'-run. There's also a sniper in the east corner near a large pit. This part can be ignored for now, actually. Enter the large building via the south entrance and head into the main foyer; to the left, is a GRENADE GUN hidden in a niche and a SMALL MEDIPACK in the NE corner. To reach the 2F, climb one of the blocks near the south entrance and jump to the arch, and from there, the next-highest level. Flatfoot-jump to the west ledge, shimmy around to a pull-up spot, then do the same on the notched pillar, landing again on the west ledge. The walkway will lead to a pull-up spot, roof-level.

The north side of the roof has a lever that closes both lower entrances -- this doesn't need to be activated (Lara can put it back to original position mind you). The rope in the middle is too far away, so maneuver to the western position and swing all the way east, where a secret [56/70] is found, a LARGE MEDIPACK and WIDESHOT AMMO. To get back to the rope, Lara must jump SW to the lower archway, then climb back up. Lara can just barely jump to the southern rooftop, which has a soldier around the corner who drops REVOLVER AMMO near a LARGE MEDIPACK just sitting there. A drop-down hole is right near there, too.

Back at the motorcycle, jump the eastern pit and continue to the western street. To get the level's other secret [57/70], there is a ledge right over the north tunnel that leads to the Trenches level. Simply pull up into it from the slightly raised ground at the fort's north side and get the items inside: LARGE MEDIPACK, FLARES, CROSSBOW POISON AMMO, and REVOLVER AMMO.

Return to the street and go to the west side -- a minotaur should appear from that side. It has a large polearm-type weapon and will bash the ground, which can damage Lara with its shockwaves. Simply raising the west gate while the baddie attacks our girl is an option, but the true way to rid ourselves of the minotaur is to lure it into the fort and trap it, then leave. In fact, you know this is the real way to do it because the game automatically shuts the gates when Lara nears the lever. However, I suggest doing the former as the time the latter buys is negligible to nothing.

But, either way y'wanna do it, Lara has to exit to the west of the fort, and after turning the gate crankwheel, there's a limited amount of time to get through. Even then, it prevents any damage but the tremors from its attack can shake Lara off the ladder. This is a stupid gameplay mechanic, but if Lara climbs up at the extreme left/right of the ladder -- so doesn't have a foothold -- there won't be any other attacks. Huh... The passage above will lead to...

---

---

26) CITADEL GATE

[WK26]

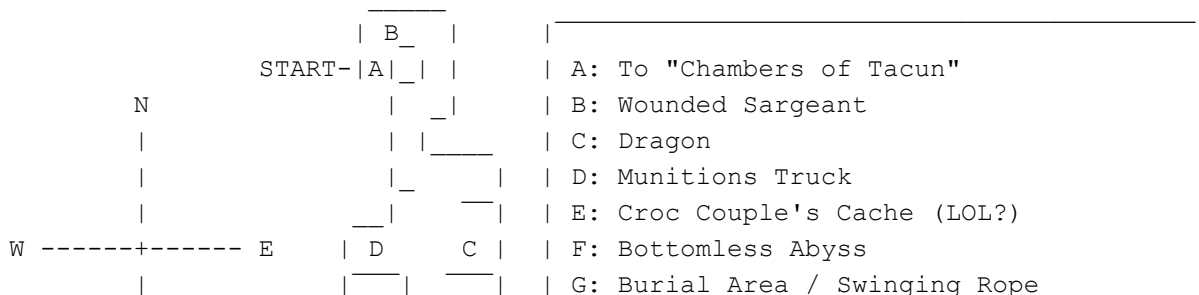

```

|           |_G1H_| | | H: Access to 2F Rope |
|           |E _ _ | | I: Nitrous Oxide Canister |
S           |I| | | _____ |
           |_F | | |
           _| | | SECRETS: 1 [58/70]
           |__|

```

Drop down into the alley and see the scene with the sargeant who says he'll help Lara to kill the "beast from ages past." Get the REVOLVER AMMO near him and continue down the street until a draconic serpent pops up from a pit. He won't move from there, but his breath attack will turn Lara to ash -- still, it can't pass through objects, so if you want the GRENADE GUN NORMAL AMMO and a LARGE MEDIPACK north of there behind a wall, feel free. It shouldn't need to be said, but the thing is invincible to conventional weapons so don't even bother.

When it shoots its projectiles, evade and run south into the street, out of its line of sight & fire, and hopefully that locust swarm is dispersing. If you want some extra items, though, Lara has to be turned into locust food! After running past the croc, look to the right (west) for a crawlspace up on the wall. FLARES and a LARGE MEDIPACK are within, and the path puts Lara out near the wounded sargeant's position. This isn't pictured on the map above, but if you want it, it's there (although it's not worth it). South of draggy, the first path to the west leads to two crocodiles living in a crawlspace, which leads to REVOLVER AMMO and CROSSBOW POISON AMMO. Further down the main avenue is an bottomless earthen pit, but there's no need to go that far along -- by the croc den is a north passage over a ledge.

This leads to a couple of odd caskets and some switches. The puzzle is to figure out which of the four switches corresponds to the engravings on the coffins, but when you consider that pulling all switches (3 below, 1 above) solves the "puzzle" of both, then there's no guesswork to be done, really. Enter the southern of the two holes first with a makeshift crowbar lever that opens a door in the northern of the two, which is where Lara should now go. That passage's lever releases locusts, and after entering the newly-opened passage, bats; and at the top, more locusts and bats! Very annoying. Save when the air is clearer.

First, let's get a secret [58/70]. Do a running jump to the rope, then turn around and look NE to where a huge bell is -- it's kinda hard to locate. Get some momentum (easier if Lara is all the way at end of rope) and jump to that alcove, then drop-n'-grab to the crawlspace underneath, which has the secret items: LARGE MEDIPACK and CROSSBOW EXPLOSIVE AMMO. For the real task, it's using the rope to jump straight south to the apartment window outcrop in the crocodile alley.

From here, start leaping across awnings and whatnot, making your way south toward the bottomless pit. The way will have some stag beetles in awkward high-altitude fighting, plus some tactics we've seen before: climbing around corners with a ladder, jumping across the alley to catch a shimmy ledge. The rewards are minimal, being a SMALL MEDIPACK. Eventually there will be a path enclosed above an arch that leads to the abyss proper. The object is to do a running jump NE out of the doorway and land over the pit, near the higher fractured road with a toppled truck. Save before attempting, naturally, and kill any bats/etc. flying around beforehand -- this jump is tricky.

By the truck, kill the two stag beetles, avoid the still-burning fire, and pick up the NITROUS OXIDE CANISTER, a vital component in giving the motorcar some torque. That's all there is to do in this level for now -- do a running jump over the abyss and exit the level, taking care to avoid any dragonfire



towards the beginning...

---

---

CHAMBERS OF TACUN

---

---

The minotaur will be running rampant, but we don't need his involvement for this level, really. Exit into the street and run to where the motorcycle is parked, then drive north to the Trenches level.

---

---

27) TRENCHES

[WK27]

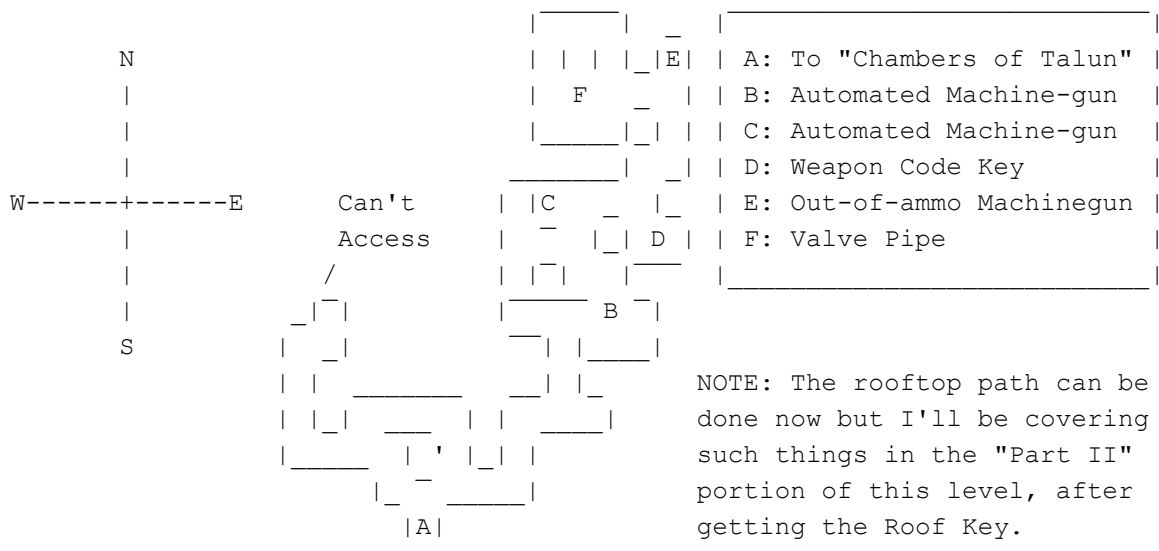

Lara starts the level in a deserted street. Get off the bike and get the UZI AMMO on the small ledge nearby, then look for a LARGE MEDIPACK in a western alcove near that NE pat of the street. The west route has two guards but ultimately has no path to take, so go down the east way where the motorcycle can't follow. After a bit of brisk walking, a soldier appears from behind a pillar; north of there is a t-junction where a machine gun fires from the east. Jump up the west acclivity to UZI AMMO and a LARGE MEDIPACK.

Save and run into the machinegun's room, taking behind the sandbags and walls in the southern area. Use the camera angle to see which way it's pointing and then snipe its back canister from the most opportune spot, being making it facing the small paneless window and shooting it from the west/southwest. The ledge with the flourescent lights has GRENADE GUN SUPER AMMO on its peak, too. Use that vantage point on the crates to jump-n'-grab the north ledge; it has a drop-down point.

Down in the blueish-green passage, the passage perpendicular to Lara's will have a machinegun staring her down. To circumvent, use the small crawlspace with exhaust pipes to kill the guard across the way, then proceed across. The soldier drops a SMALL MEDIPACK and WIDESHOT AMMO is near his vicinity. The elevated position there will allow Lara to snipe the turret's weakpoint and proceed east. Just shotgun the guard who appears.

At the end of the corridor is a crawlspace leading south, to a soldier corpse and the WEAPON CODE KEY Lara needs for later (this seems to shuts off the 3rd machine-gun nest). The passage north of there seems normal but the walkway under the steam jet is actually a huge abyss -- a nice illusion! Use the lit-up groove to shimmy across, dropping down by turret #3. This one is out

of ammo or something, so get the LARGE MEDIPACK on its ledge and continue west to an overturned jeep and a soldier waiting for Lara.

When things are clear, crowbar a VALVE PIPE from underneath the vehicle's hood. Combine this with the Nitrous Oxide Canister (if you got it from the Citadel Gate level previously) to make the NITROUS OXIDE FEEDER. Return to the motorcycle and Lara will attach the object, which lets her have boosts of speed with the 'sprint' button. [NOTE: Lara must manually attach this item; it doesn't function automatically.]

That's all for this level, for now. There are now two small things to do in previous levels that I'll detail in the next section.

28) CITY OF THE DEAD, PT. II / CHAMBERS OF TALUN, PT. II

[WK28]

TECHNICALLY, both of these are optional: the secret doesn't need to be gotten and the Roof Key doesn't have to be used in the Trenches level...but in the spirit of the game, we're going to get everything. We'll start with the level nearest.

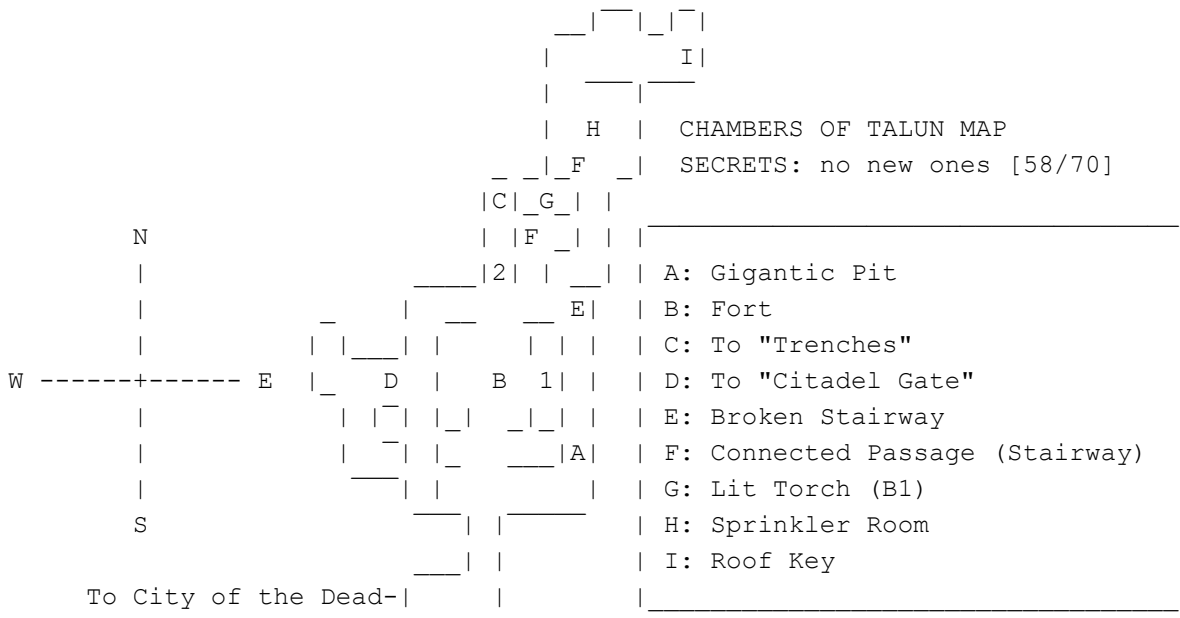

This part requires the Nitrous Oxide Feeder, a combination of the Nitrous Oxide Canister (from Citadel Gate) and the Valve Pipe (from Trenches). Enter the level -- the minotaur shouldn't interfere with this portion -- and note the broken stairway in the NE. Do a nitro-boosted jump off this to the small upper corner, then disembark and kill the soldier in the nearest doorway. A slope is inside that leads to the lower room.

The downward ramp to the west leads to a previously-locked door accessible before, but since there was nothing but a soldier there, we ignored it -- go kill both down there, now. In the room Lara just slid into, kill the soldier in the north dead end, take the torch there, then light it on the flaming one all the way downstairs. Return back upstairs and stand near the southern (locked) door -- there are two sprinklers overhead. Press action underneath 'em to set off the sprinkler system, which opens all locked doors around.

The newly-opened door upstairs (south) leads to a lever that lowers a freight box into the room where the torch was initially. Use it to get to the ledge behind there, where a SMALL MEDIPACK and CROSSBOW NORMAL AMMO are. A locked door behind a box is padlocked, but this can be shot off. Inside the wall's mechanism is the ROOF KEY -- mission accomplished! To exit, return to the

sprinkler room's lever area and the path back to the motorcycle is open to the west.

Now for Cairo's first level, City of the Dead! The exit is in the far south of this level, past the road pit, y'know.

A: Revolver (Dropped by Soldier)	I: Lever / Water Room
B: 1st Automated Machinegun	J: Connected Path (Crawlspace)
C: Garage / Motorcycle Ramp	K: Gate Switch
D: East-alley Crawlspace	L: Grenade Gun
E: Large Locked Gate	M: Gigantic Pit
F: Rooftop Machineguns / Helipad	N: Draggable Soldier Corpse
G: Bat-filled Portico	O: Building Husk
H: Soldier's Corpse / LaserSight	P: Rooftop Access

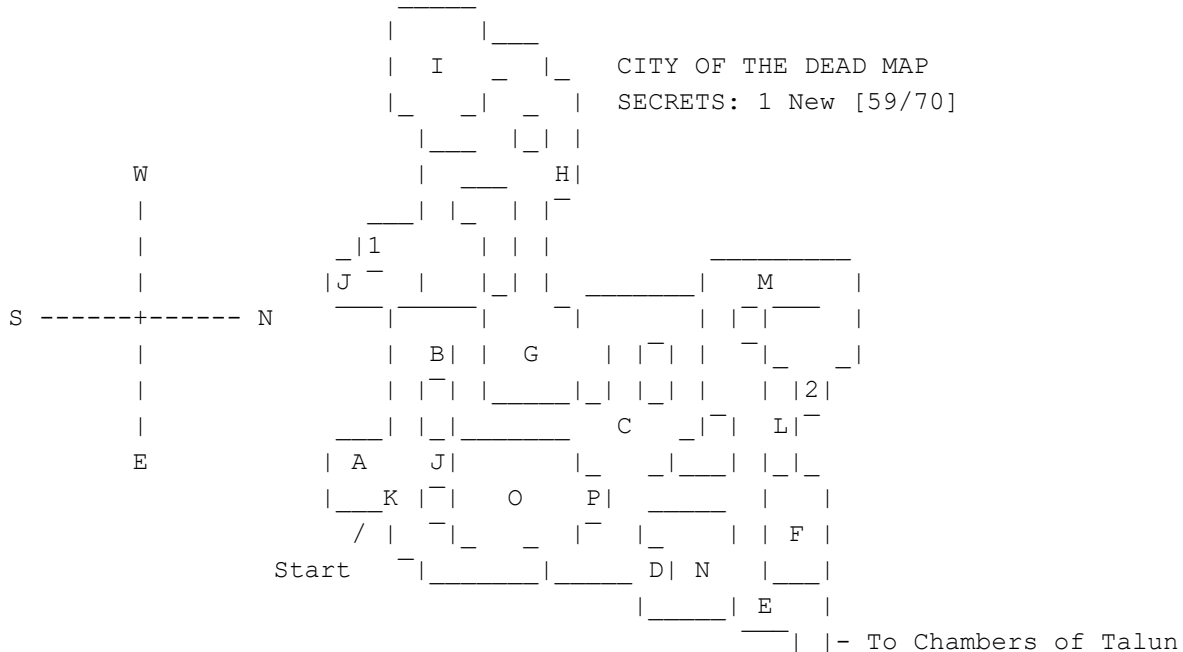

2ND SECRET

The purpose of being here is to get a secret. Lara enters near "E" and must go west up the street to point "M", a gigantic pit (there may or may not be a soldier here if Lara killed him previously). She'll need the nitrous oxide boost to get over, though. Run over the soldier there and get on foot to the four slanted pillars. Pull up onto the south one and hold the jump button -- Lara should do a bunch of flips/jumps, eventually landing to the east. If she didn't make it right, try centering her position on the 1st pillar, etc.

The secret [59/70] is in a small area behind a street-level building, and contains GRENADE GUN SUPER AMMO, CROSSBOW EXPLOSIVE AMMO, and a LARGE MEDIPACK for all that trouble. Climb back west and return to the motorcycle -- it's time to revisit the Trenches level with the Roof Key obtained in Chambers of Talun! [To leave, use the dirtpile ramp to vault over the pit. Use the alley nearby to pick up speed if needed.]



Jump down into the warehouse -- which looks suspiciously like a replica from the movie Reservoir Dogs (1992) -- and approach the soldier to obtain the MIND DETONATOR BODY. He says his friend has the explosive codes but a monster ate his head or somethin'...weird. Grab the HANDLE from a workbench and the CAR-JACK BODY from behind the policecar. Combine the two new items to create the CAR-JACK proper; we'll be using this later. The red button here leads to the south crawlspace and LARGE MEDIPACK, then take the ladder near the entry point to reach the rafters.

Leap to the notched ceiling, drop at the stair, climb into the blue crawlspace that leads to a roof grate. It's locked, but by using the complete Car-Jack on the low cement wall there, it will unhinge the thing. Avoid the lightning rod up there and go behind it, weathering the locust swarm all the while. Push the low box north into the alcove, then pull the large machine out and near the lightning rod. Save and move it onto the lightning rod pad, blowing up part of the bridge (what the heck?).

Do a running jump to the notched siding of the roof ahead, then shimmy north to a ledge. Look NE to the greenish-hued path just around the corner. Do a 2nd running jump to clear the slanted portion, then find the secret [60/70], a LARGE MEDIPACK, GRENADE GUN FLASH AMMO, and CROSSBOW POISON AMMO. Jump back to the normal side of the building and take the small passage to a bunch of slopes (softdrop-n'-grab to avoid damage). In the NW corner of this new area is the headless corpse by the MINE POSITION DATA, which can be combined with the previous object to make the MINE DETONATOR.

After collecting the item, a Guardian (like in 'Guardian of Semerkhet') shows up to party-crash. Pick up the FLARES quickly and lure it into smashing the boxes in the SE corner, which gives balcony access with a soldier to KIA. The exit's in the south.

---

---

#### TRENCHES

---

---

The slide deposits Lara near the initial street. Return to the alley that leads back to the Street Bazaar and at the base of the sandy slope will now be a flat surface; this can be used to catch a ledge and climb back up to the motorcycle. Enter the bazaar once again.

---

---

#### STREET BAZAAR II

---

---

The door in the warehouse is now open and leads to a street-level exit that we passed over before (via the broken bridge). Kill the two soldiers around the area, pick up the UZI CLIPS and exit northwest.

---

---

#### TRENCHES II

---

---

Alongside the warning fence, use the MINE DETONATOR to blow the underground explosives and clear the way. The red button there opens a gate near Lara's motorbike, which she can drive through now. Splatter the shotgun soldier and

arrive in...

---

---

31) CITADEL GATE, PT. II

[WK31]

---

---

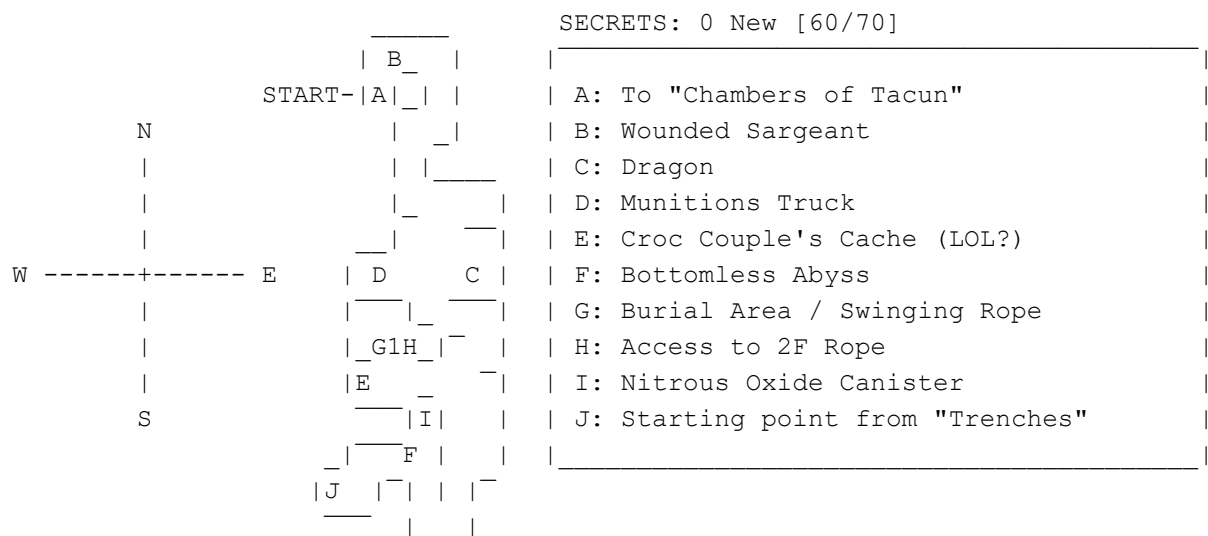

Save and use a nitro boost to get over the fenced-off abyss. Land northward or Lara might take a huge fall! Circle around to the main street and smush the two crocodiles running around. From here, drive past the dragon and to the sargeant up the street for a cool cutscene involving the munitions truck. Lara will automatically start the final level of Cairo now.

NOTE: If you can't trigger the cutscene with the sargeant, it's probably because you're not on the motorbike. That's a requirement, y'know.

---

---

32) CITADEL

[WK32]

---

---

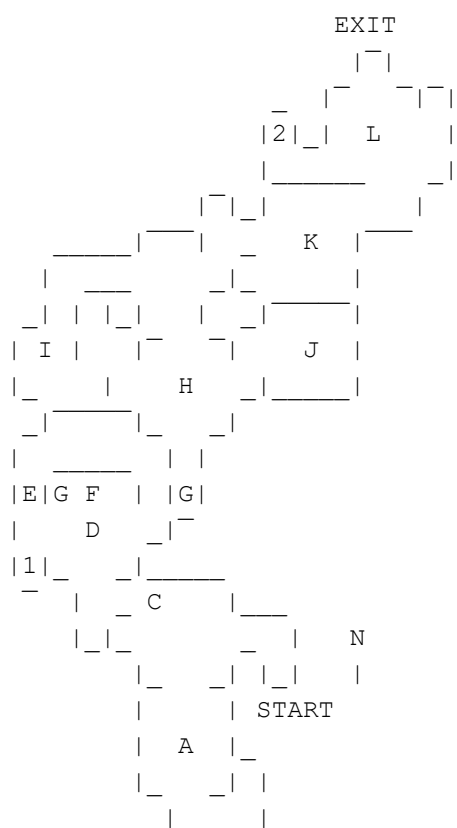

```
  _ | | _  
  | B |  
  |_____|
```

A little ways in, see the scene with Jean-Yves and he'll leave. Continue as far south as possible, until a stairway can be found leading to a lever (bear with the wonky fixed camera angles here). This opens a door in the 1st hall, leading to UZI AMMO, although before getting it, pick up the torch in the lever room and light it. See the rope moored to part of the wall in Room "A"? Jump to the ledge there and the lit torch will burn the sucker to ash, making a trapdoor trigger in the initial room.

Follow the tunnel to WIDESHOT AMMO in a south corner, then proceed north to a multistory room with a watery bottom. A small scene shows a blue assassin (remember these chumps?) run to the top near a lever, and if Lara's feeling spry, she can snipe him from her starting alcove. Flatfoot-jump to the NW ledge and ignore the large medipack in a north path -- it's boobytrapped w/ a firejet duo. Instead, jump to the west staircase, grab the notched ceiling and look out for a south crawlspace Lara can drop-n'-grab onto. This leads to a secret [61/70], GRENADE GUN FLASH AMMO and a LARGE MEDIPACK. Drop down into the pool of water back in the main series of rooms then swim to Room "D". One can get back to the room's starting (south) entrance by surfacing and doing a running jump-n'-grab to the west block.

Once back up, return to the stairway shaft in the west. You may have noticed that there's a groove that spirals down its length when falling before. To take advantage of this, stand on the east side of the shaft and do a drop-n'-grab to the highest point of the groove right below. Shimmy along until Lara can drop to the next groove, and eventually take it all the way to the north crawlspace with UZI AMMO inside. Then, it's an east crawlspace with a slanted block underneath. When the slide begins, do a backflip to avoid falling into the water (save before attempting), then jump off a 2nd block to snag a north ledge with a SMALL MEDIPACK inside.

Do a running jump south, grabbing the next ledge at the stairway's bottom. Be prepared to kill a 2nd blue thug, and finally get to the lever at the top of the multistory room -- this turns off the flametrap below and unleashes a 3rd thug. The pit near the lever is a shortcut to the LARGE MEDIPACK's location, which also has an exit that leads east. This spits Lara out near what is affectionately known as the "Compass Puzzle."

First, get all items (GRENADE GUN SUPER AMMO, SMALL MEDIPACK, GRENADE GUN NORMAL AMMO) and save. The pedestals here have letters etched on their tops, and the four spots on the grooved floor correspond with cardinal directions; Lara should double-check her compass if unsure of which way's which. Move the pedestals to their appropriate location -- 'W' to West spot and so on -- to make the doors open.

Hit up the west entrance to start. It's surprisingly straightforward going, too! At the first pull-up point, a small pit in the south has useless FLARES (I mean, I had 230!) and another in the room's center drops into a flooded passage. There are three exits here, too: west, north, south. Take the latter first and locate a ceiling lever (and SMALL MEDIPACK) at the room beyond, then go north. There's a sunken chain here but it can't be used. Get REVOLVER AMMO before leaving back to the compass room where Lara should go east.

Kill 2 henchmen and pull the lever, draining water in the western of the 3 sunken passages at point "I" on the map. Get there in your preferred fashion, and pull the lever to open the floor trapdoors in the adjacent room, one of which has UZI AMMO. The north room with the sunken chain ain't so watery

anymore, and the chain opens a door in that same room. Kill a thug who drops a SMALL MEDIPACK and continue east after saving.

---



---

THE 2 KNIGHTS

---



---

Upstairs our girl finds the two zombie knights her nemesis reanimated. They can't be killed or damaged by conventional weapons, so take the easy way out by climbing the scaffolding to the upper (gray) walkway. Wait near the NE blocked-up beams and the slowtastic knights will eventually walk up the ramp. The goal is to get their sword swing to break the beams, from which Lara can jump-n'-grab to the next level above.

Beyond is a lonely chamber with lit torches. FLARES and UZI AMMO are around the NE corner. To get the final secret [62/70] of this level, drop-n'-hang in the deep west shaft and drop-n'-grab to the crawlspace lip below. Jump up the steep-looking slope and climb to a higher room with two knights guarding WIDESHOT AMMO, GRENADE GUN FLASH AMMO, CROSSBOW EXPLOSIVE AMMO, a LARGE MEDIPACK, and REVOLVER AMMO. Slide down the slope to re-enter the room containing the shaft.

To finish the level, enter the pit surrounding the shaft and go north -- Lara automatically steals the AMULET OF HORUS and we're in a new level, now.

---



---

33) THE SPHINX COMPLEX

[WK33]

---



---

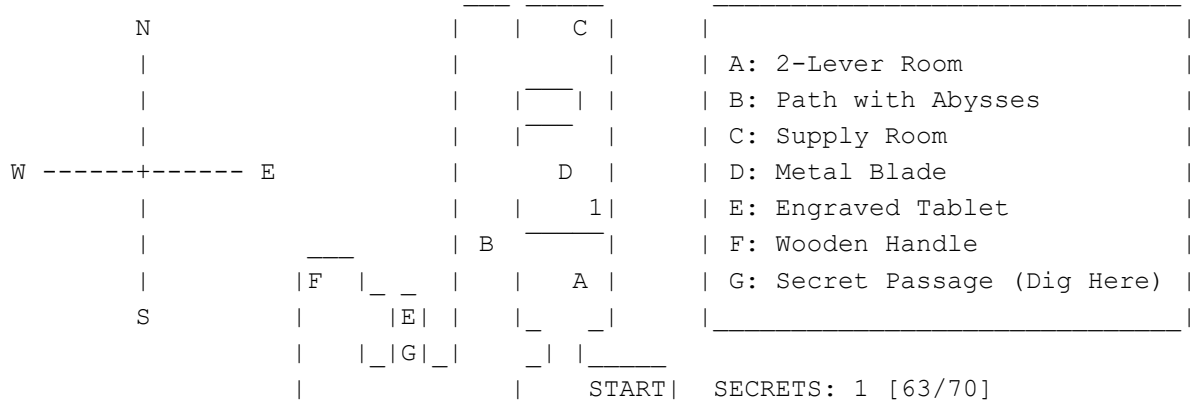

The first level of Giza starts Lara on a dirt road. Two blue thugs try for first blood, one of whom drops a SILVER KEY that can be used on the door nearby. Inside, two more goons perched on a wall pester our gal. Take the SMALL MEDIPACK in the SW corner and then jump to the NE & SE levers, both of which are needed to open the west door. Kill the ninja henchman and go through the new door.

The adjacent path has two abysses, one in the south and north. Since we want to get a clever secret first, take the north path, which is rather simple to cross except for the last jump, which requires Lara to do a running jump and catch the north side of the pit. After pulling up, jump to the first ledge of the next pit (by a LARGE MEDIPACK) and kill the assassin who opens fire. Get to the north side and enter the blue door.

Pocket the UZI AMMO inside a crate and pull back the southern supply shelf, revealing a covered crawlspace. Shoot yer way inside and find the adjacent



room to the south with a single henchman inside. Get the METAL BLADE in a crate and the SHOTGUN SHELLS by the exit button, then kill the two thugs who appear outside. Now, to get the secret [63/70], push the two side-by-side shelves north, picking up the SHOTGUN underneath. This might be the only secret in the game that doesn't involve finding a hidden room!

Continue west until Lara's eyes catch on an engraved tablet at the sphinx' feet; approach for a deciphering scene. Save and cross the western abyss, after which two ninja henchmen bumrush Lara -- be careful! The crate near the do-not-enter door north of there contains a WOODEN HANDLE, which can be mixed with the Metal Blade to form the KATANA OF DOOM...not! It's really a SHOVEL. There's a small ledge there that lets Lara get on the sphinx' paw, too, and WIDESHOT AMMO are at its tip.

This wouldn't be an archaeological dig without actual digging, would it? Get back to the engraved tablet and stand on the dry cracked earth in front of it. Select the Shovel to uncover an earthen tunnel below, which ends the level.

---



---

34) UNDERNEATH THE SPHINX

[WK34]

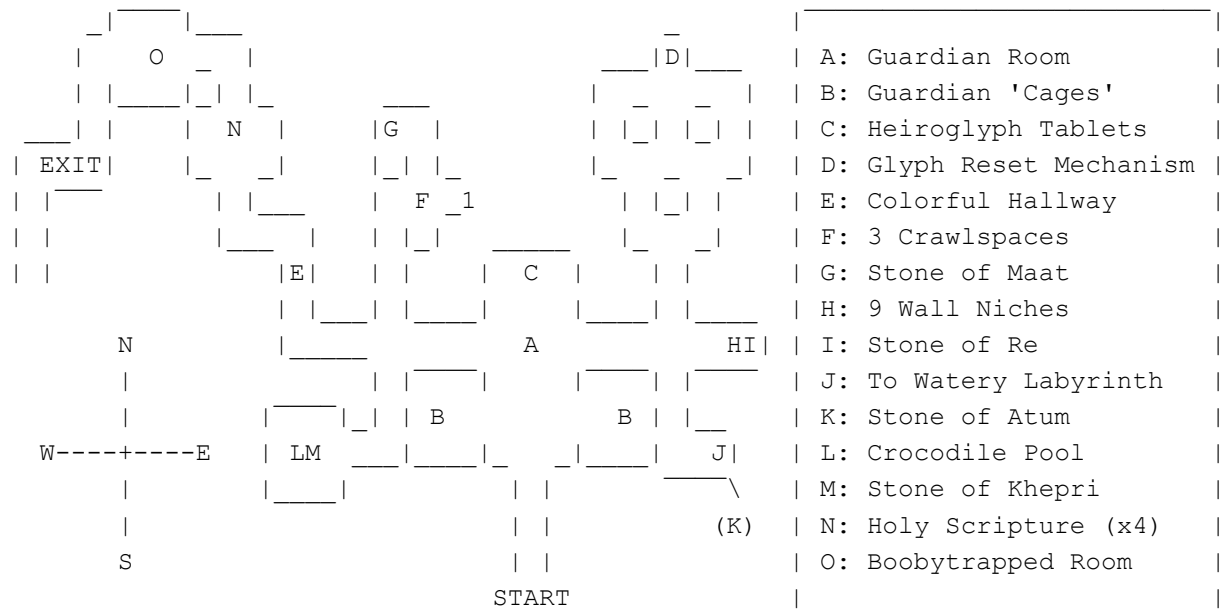

Upon entering, Lara is locked into the first room, which has two (sleeping) guardians in the north near some wall tablets. They won't come alive if Lara flanks them, but this may be tentative as the game progresses. The recommended way to neutralize them is to awaken them one at a time, then trap them in the closable doors ("B") -- just bait 'em in and quickly drop the portcullis. If they're gone, then proceeding is much easier.

Now then, west of this chamber is a skeleton with FLARES and a SCRAP OF PAPER laying beside him. No, it's not Lara's nemesis, sadly! Now, this paper scrap tells the Western equivalent of the heiroglyphs on the three tablets. Push them in this order to open a single gate: rightmost, leftmost, middle. [Any other combination opens the NE passageway that leads to the puzzle's reset mechanism, past a boobytrapped hallway prefaced by a huge pit. Just start over if this way has to be taken.]

The path in the west leads to a large pit in the "valleys" of the sloping corridor, so make sure to walk carefully. Upon reaching the gate guarded by two statues, there will be colored lights up higher slanted slopes. Using

the binoculars' flashlight, Lara can see four different sets of paths that can be opened.

ORDER	DOOR OPENED?
Bird, Triangle, Reed	Northwestern
Reed, Bird, Triangle	Northeastern
Reed, Triangle, Bird	Eastmost
Triangle, Bird, Reed	Southeastern
Triangle, Reed, Bird	Southwestern

Since there are only five other doors to unlock, the other combinations are not that important. I'll just go in clockwise order. [NOTE: If the tablet combinations don't work, it's because you didn't view the solutions in the colored slopes -- ALL must be viewed.] The order they're done in doesn't matter for the most part.

#### NORTHWESTERN GATE

Kill the bats and get to the do the jumping course to find a crossroads with three crawlspaces. There are spike traps within here that will kill Lara w/o much trouble, but these should be easily spotted since they're wooden trap-doors and clash with the game's graphics. But anyway, follow this to the letter.

NORTH CRAWLSPACE: North, West, South -----> STONE OF MAAT  
 SOUTH CRAWLSPACE: South, East, South, East, South, East --> Switch

With the Stone of Maat found, save in the crossroads room and crawl down the east 'space. Go south to the wooden trapdoor, which doesn't have spikes underneath but a secret [64/70], a GRENADE GUN. If you already triggered the south crawlspace's switch, the way back out is open.

#### NORTHEASTERN GATE

This leads to the puzzle reset mechanism -- don't bother going this way.

#### EASTMOST GATE

Kill more bats and reach the chamber with 9 wall niches. Even with the Scrap of Paper, I didn't really get if there was some sort of puzzle to do here. The rightmost niche on the north side opens the exit gate, and the rightmost niche on the east side contains the STONE OF RE. [If someone knows what the logic here is, e-mail me 'cause I'm kinda interested.] All other niches will drop scarab swarms in, so avoid those!

#### SOUTHEASTERN GATE

This gate can be kind of annoying. Cross the abyss using the flat areas and arrive in front of two statues and a watery hole. Kill bats and prepare for the plunge! There is a watery labyrinth beyond, and while the map is a simple

	top-down view, it's actually got a lot of vertical passages
#4	and such, leading to surfacing points. 'S' marks the start
N	point from "J" on the main dungeon map.
S #5	The first spot to target is surfacing point #1 above a bird
	heiroglphy in the tunnel, which opens a trapdoor at the #2
_       _	point. This goes on for awhile; it shouldn't be hard with a
#2	map. By #4, west of there, is a SMALL MEDIPACK in a niche,
	if y'want to get it. Surfacing point #5 has a switch that

```

| | _____ | | opens the exit, plus has a STONE OF ATUM opposite there.
| | #3 |
| _____ | |
| | | | Returning to the starting point shouldn't be hard, but know
| | | | it's the only vertical passage that leads somewhere that is
| | #1 | | _not_ marked by a heiroglyph. Getting back to the entrance
| | | | from the abyss room requires a running jump and grabbing the
| | | | edge of a sloped ledge to pull up normally.

```

SOUTHWESTERN GATE

As is the norm, kill some bats and cross the gigantic abyss. The pool room beyond has some crocodiles that need to be thrown off the mortal coil. Near each of the corners is a wall mechanism; when all are triggered, a trapdoor in the pool's island leads to a STONE OF KHEPRI. The east wall has a switch that opens the exit gate. Save before making the jump back across the abyss, as this one requires pinpoint precision from a triangular-corner slope to the outcrop Lara probably jumped off on her way in. [Protip: hug the wall.]

WHEN ALL (4) STONES ARE OBTAINED

Return to the western passage (with the colored lights/hallway) and place all four Stones -- Maat, Re, Atum, Khepri -- in the receptacles to open the exit gate. Before leaving the level, however, traverse the abyss via the notched ceiling and enter the adjacent room after killing more bats. Lara will be locked in and the ceiling will start to move. Collect the 4 HOLY SCRIPTURES from the floor alcoves and exit before becoming a blood puddle (it's like a mud puddle except red).

The final stretch is getting past the boobytrapped room beyond. Floor blades will snap up like venus flytraps (at both entrances to room), so walk slowly to trigger and avoid, then use the 2nd set of ceiling bars to blow this joint once and for all. Naturally one last bat has to appear...

35) MENKAURE'S PYRAMID

[WK35]

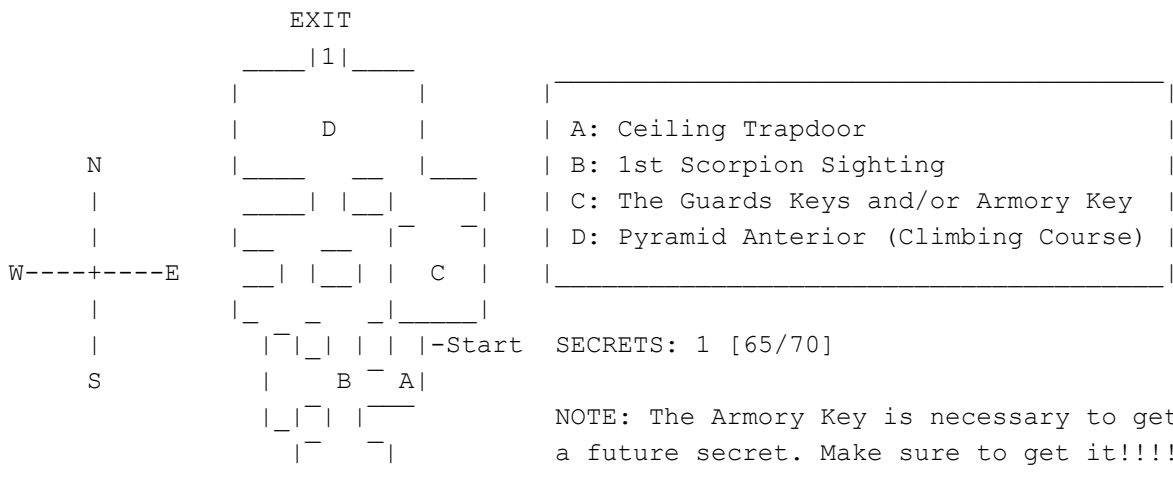

NOTE: The Armory Key is necessary to get a future secret. Make sure to get it!!!!

Pick up the UZI AMMO in the southwest corner then climb the blocks in the SE corner, leading up to a ceiling trapdoor. With a bit of positioning, Lara can jump-n'-grab its southern handle (face north while doing this). Up top, kill the gigantic red scorpion. If you want a gauge of its health, it took three grenade rounds to die. The south path just beyond there has a man shooting at a scorpion, and he drops REVOLVER AMMO; the western path has a LARGE MEDIPACK to pick up. To get out of this area, jump the north abyss on the left (west) side. Looks hard, but it's possible. There's just one more scorpion beyond

before the north path is clear. Do a running jump-n'-grab to land by the foot of Menkaure's Pyramid.

Pull up and devour the big scorpion and stag beetle. To the east, there's yet another abyss. To get across, look for a southern broken ledge that, when stood on, slides Lara south; at this time, jump to find flat ground. The next pit is untraversable so break down the modern door to the south after saving. Inside is a scorpion attacking a guard, and whether he lives or not -- as well as whether Lara can get a level's secret or not -- will depend on if the scorpion is killed first. If Lara saves the guard, he gives THE GUARDS KEYS (sic) and ARMORY KEY as a reward. Check the room for a 2x SMALL MEDIPACK, WIDESHOT AMMO, and SHOTGUN SHELLS before leaving. [NOTE: The guard, if dead, only drops The Guards Keys.]

CLIMBING MENKAURE'S PYRAMID

Return back to the base of the first pyramid catching a higher ledge and shimmying around the corner, dropping onto flat ground. The next part will involve climbing the pyramid to a higher door. The starting point is at the SE corner. Since flat parts mean the right way is being taken, feel free to save on the way up. Do a few jumps NE until finding a stag beetle up there. From there, do a running jump west; Lara should slide down to a lower rim with a 2nd stag beetle.

From there, climb up twice, jump to NE block and climb up twice again. A running jump east should land at the entrance, where a 3rd stag beetle is waiting around. Use 'The Guards Keys' to unlock the door. Save here, but don't go in yet.

To get the secret [65/70], there's more climbing to be done. From the outer platform with the door, drop down the SE side. Do a running jump east and climb up a bit until a 4th stag beetle rears its face. Climb more until Lara is level with the top of the doorway below, and can do a standing jump west to the items on some ledges: SMALL MEDIPACK and a REVOLVER!!! Note that the Revolver is the secret, not the medipack. Scarabs will drop in from somewhere immediately, though, so quickly exit the level via the unlocked door below.

---



---

36) INSIDE MENKAURE'S PYRAMID

[WK36]

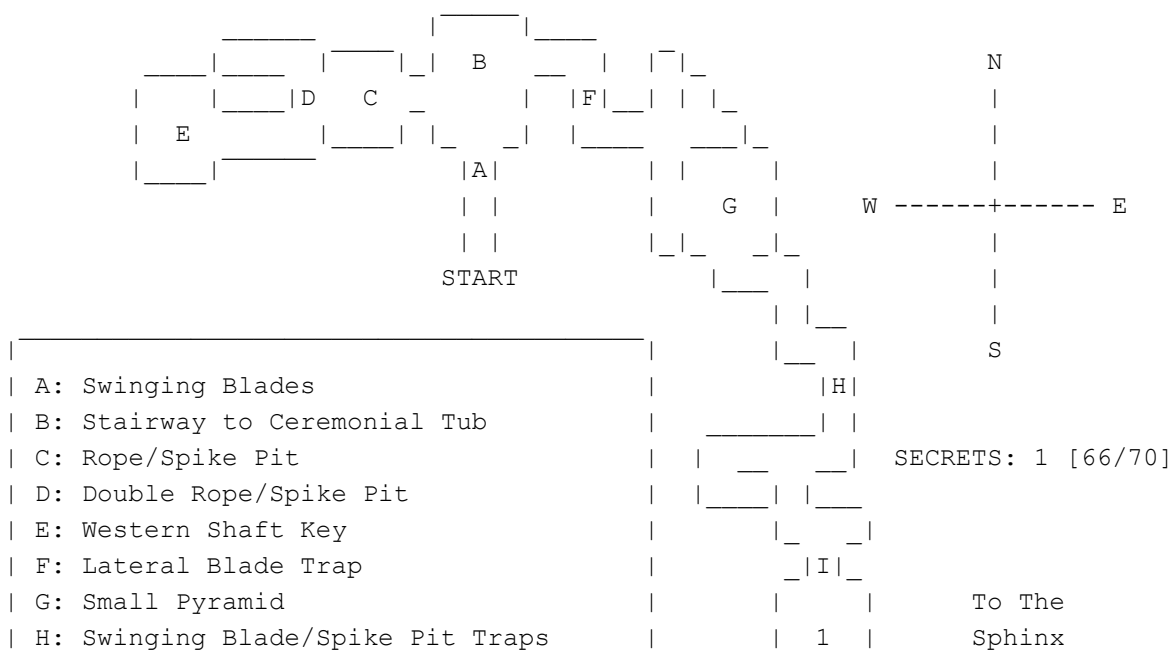

| I: Sloped Cavern | | \_ \_ | Complex  
| \_\_\_\_\_ | | \_|-----'

Some swinging blades mark the end of the entrance slope, and past there, a bat or two. Use the down-stairway at the end and Lara's sight will be caught on a 6-pointed star on the ceiling. Snipe it with your preferred weapon and a trapdoor triggers in the lower room with two mummies (blow 'em up!). Jump into the large ceremonial tub and continue, after getting the REVOLVER AMMO in the room, that is.

The passage leads to a rope hanging over a pit with retractable spikes below. Beyond are two more similar setups with mummies guarding both. The northernmost of the two leads to a switch that opens the door in the southernmost, so that is the order of procedure. Up the trapdoor, a bird guardian will start with the energy projectile slinging. Pick a fast weapon like the uzis and stay active in some way, even if it's just jumping up and down. Crowbar the WESTERN SHAFT KEY out of its socket and a wall portion lowers in Room "B". This means backtracking all the way there -- have fun!

When the corridor becomes level, start crawling to avoid the lateral blade trap that springs. At the next incline, catch the pesky trapdoor's underside and pull up to the outdoors, which is across the huge pit near the scorpion/guard fight in the previous level. Nix the two scorpions and look for a small earthen-colored button on one of the smaller pyramid's sides. This caves in the top of the other and releases a 3rd scorpion. To climb this one, start on the west side, jump SE, then do a running jump south. [NOTE: Even if Lara slowly walks here, she can still slide in the abyss; save first!]. Once over, it's simply climbing to the top in an easy manner.

Now, the top of the pyramid leaves a huge shaft behind and the inner wall is notched for climbing. Downstairs, continue to a spike pit to get by and an abyss to cross by swinging on the ceiling. The next spike pit has a moving guillotine blade, so time the jump-n'-grab carefully. Once y'got the hang of doing this, there are two more to do in the same fashion...hooray for you! Past the 3rd, there's a chain that opens a portcullis somewhere nearby. To find it, use the notched ceiling between the 2nd & 3rd spikepits to reach the passage. SAVE!

This part regards the secret [66/70]. Slide down the first slope and jump to the right (SW) to land in the 1st spikepit's safe zone. The reward: an UZI. From there, slide down the normal route and exit south.

---

---

#### THE SPHINX COMPLEX

---

---

Yup, back to Giza's first level. Climb out of the pit near the engraved tablet and go to the SW abyss. The object is to get to the corner door which can be opened with 'The Guards Keys' obtained previously. That's where the exit is.

---

---

#### 37) THE MASTABAS

[WK37]

---

---

PATH: Above-ground Mastabas

| A | B | H | L | | O |

N

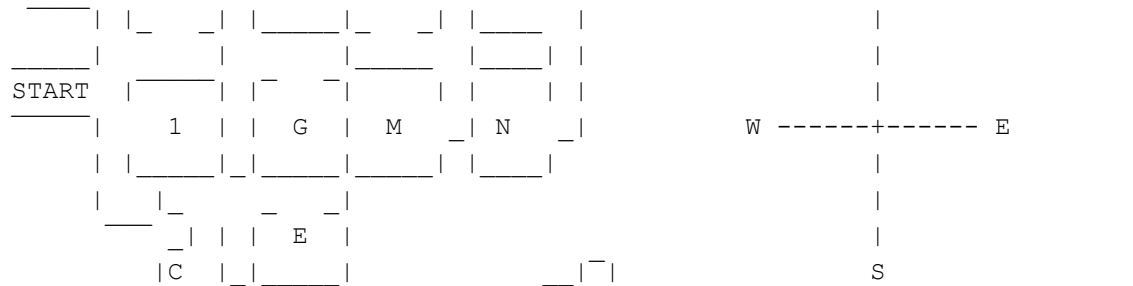

PATH: Underground Tunnels

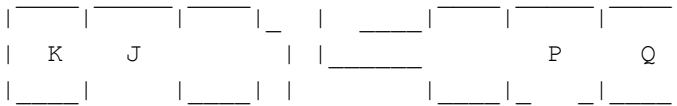

SECRETS: 1 [67/70]

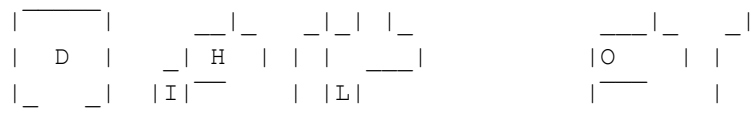

Letters unseen below = connected path

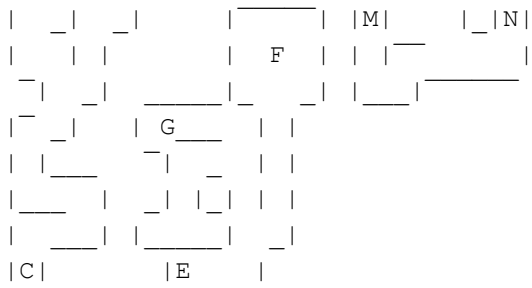

- | A: Jerrycan
- | D: Small Waterskin
- | F: Bag of Sand
- | I: Torch
- | J: 3-Scale Room
- | K: Northern Shaft Key
- | P: 3-Statue/Lever Room
- | Q: Southern Shaft Key

'Case you don't know, a mastaba is a flat-roofed Egyptian tomb, so that's what this fun level will be full of. Kill the two mangy dogs nearby and pick up the JERRYCAN by the gas station pumps. The entrance is locked so we'll leave it alone. The mastaba with a 'do not enter' sign in can be broken into but there's only bats to disturb...or so it seems. Actually, a trapdoor is camouflaged there and leads to the level's secret [67/70], a LARGE MEDIPACK. The building north of there has a trapdoor to take too, but this one's in plain sight. There are numerous mangy dogs below, so take care.

Anyway, take the east passage initially and arrive in an underground room with wolf head statues (or is it authentic taxidermy?) and a couple doggies. Get the SMALL MEDIPACK and CROSSBOW NORMAL AMMO, then shoot all the gems in the statues' mounted heads to open the locked door here. It contains a SMALL WATERSKIN guarded by a mummy. Leave this are and continue south through the rest of the unexplored passage, which lets Lara back into the fresh air in the above-ground region's SW corner. Kill all mutts, small scorpions, and bats, then do a running jump east to the next mastaba. This has a don't enter sign also, plus some more moronic bats/dogs inside.

Back in the trapdoor tunnel, go to point "F" and kill any evil creepies that are there. Like before, shoot the gems in the wolfhead statues' mouths to open the back door. Past the mummies and bats, is a BAG OF SAND. Return back to the rest of the tunnel and there will be a dead end with REVOLVER AMMO and a LARGE MEDIPACK. The only other way north leads to a pull-up point near the street (with bats...it's always with bats...). The huge abyss can only be crossed in one direction, and that's jumping NW near the building's corner and landing on a fragment of solid ground. Save beforehand, natch. From there just jump around the corner to Point "H," kill scorpions, and enter the next trapdoor.

At the fork, go back west and find a TORCH past a soon-to-be dog corpse. Take it to point J, kill the dogs/bats, and then break the wolfhead gems to unlock the door. Beyond are two bats and a triple scale puzzle. To solve, use the Jerrycan on the center scale and light it with the torch; the Bag of Sand is to be placed on the eastmost; and the Small Waterskin dumps water in the westmost, after it's been filled in the small pool within the room. West of there are two mummies and a crowbarrable NORTHERN SHAFT KEY, the taking of which opens a far-east door. The nearest east door has CROSSBOW POISON AMMO and REVOLVER AMMO near a ramp with 2 dogs. That east stair leads to a dead end with a LARGE MEDIPACK, the other a pull-up point.

Back on the street, 86 some scorpions and jump NE along the small ledges to another mastaba (save here). From there, jump-n'grab south of there and kick in the door of the building there and descend into the tunnels again. There's only a couple scorpions and REVOLVER AMMO, making this one of the easier ones to navigate. Climb up to the street level and enter the do-not-enter house for yet another trapdoor tunnel entrance ("O").

Get the SMALL MEDIPACK in the dead-end tunnel toward the start, killing the dog that assaults Lara. Through the dog/bat den, proceed to break the wolfhead gems until the north door unlocks and leads to a chamber with 3 statues and levers. They're sculpted in the "see no evil" poses and such and appear to be elephants, although you'll soon find they're monkeys. Only the eastmost does anything helpful, releasing a monkey who opens the east door; the other two will simply make aggressive foes and we don't need that flack.

Pry the SOUTHERN SHAFT KEY from the east mummy room -- this should be the 3rd and last Shaft Key in Lara's possession -- and exit through the newly-opened west room & passage, which leads to the exit.

---



---

38) THE GREAT PYRAMID

[WK38]

---



---

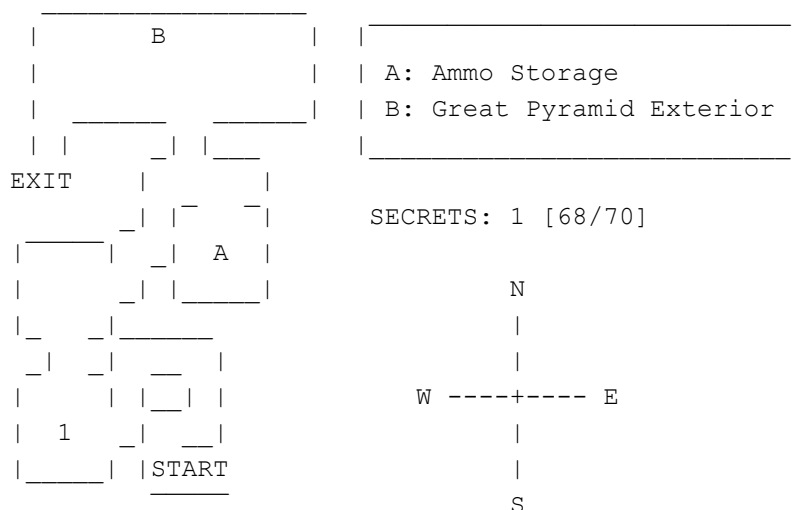

FINAL MASTABAS

---

Huh? Didn't we see this level in the first Tomb Raider game? Well, we're back once again. Exit out of the boarded-up mastaba and crush the blue henchman just standing there. Jump to the SW edge of the abyss and kill the northern henchmen who strikes first blood. The adjacent mastaba with a stag beetle inside has a camouflaged trapdoor -- the creators tried that trick again -- that leads to the only secret here [68/70], a GRENADE GUN.







Yes, there are plenty of wall niches; no, they're not special. Most will send scarabs in or have nothing of interest. The Bird Guardian was faced before and wasn't that special; try to keep active and get behind it to stop the constant barrage of projectiles. Pry the EASTERN SHAFT KEY off its socket afterwards and it'll be time to leave this pyramid. The way back is as such:

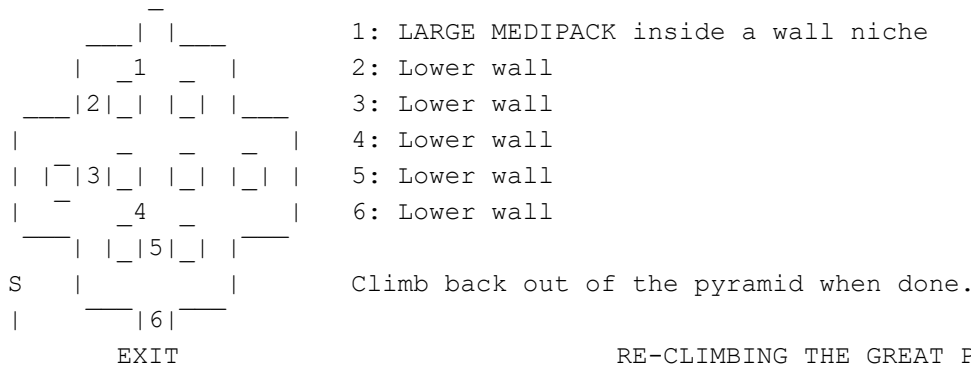

RE-CLIMBING THE GREAT PYRAMID (EXIT)

Back across the abyss, jump north some more until Lara can pull up onto the queen's pyramid near a stag battle. After climbing around the Great Pyramid's exterior once already, this should be child's play -- it's mostly a bunch of diagonal jumps, and there are still falling boulders. Eventually there's a ledge with a door 'The Guards Keys' can unlock plus some stag beetles as the kicker! Enter inside

40) INSIDE THE GREAT PYRAMID

[WK40]

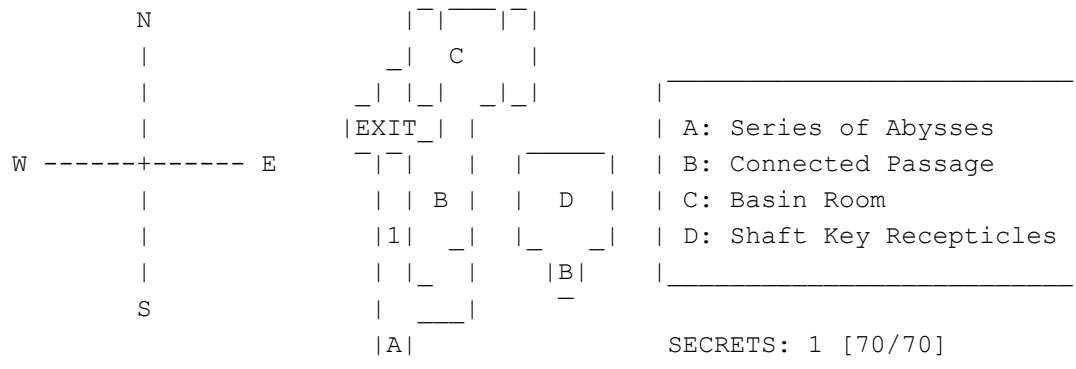

Right at the start is an abyss to leap over with two assassins, one of each kind, ready and willing to fight. How did they get inside when Lara had to go through 23423 levels!? Argh! Take your age out on 'em and steal one of the corpse's UZI AMMO before taking the sidepassage one of the assassins jumped out of. This leads upwards to another chamber, past a blue henchman, which locks Lara in with another ninja henchman and bat. Take the lower path and a sliding pillar trap activates, but it's crossed easily, generally.

Beyond, kill three mangy dogs and SMALL MEDIPACK in a broken basin. The torch inside should be used to light all the unlit (x4) ones, which opens a western alcove with a switch and WIDESHOT AMMO. The switch lowers a wall portion one room back, but you'll have to put down three more stray mutts before getting there.

The room unlocked has sockets for the four Shaft Keys collected throughout the Giza levels. Place them all in and a floor hole opens! The switch opens the locked gate from the "B" room, letting in two blue henchmen all the while (one drops SHOTGUN SHELLS). Return to the basin room and the east alcove will be open -- it has a LARGE MEDIPACK and a lever that raises the portcullis in

the initial hallway of this level.

Backtrack there and kill the two blue assassins -- a SMALL MEDIPACK is left behind. Continue north, jumping to safe spots on the abyss and shooting bats who threaten to knock Lara downwards. Near the lower gate is a LARGE MEDIPACK on a stoop. With all threats gone, let's get the final secret [70/70] this game has to offer! If you stand by the door leading to the beam of light, the secret would be in the third one away from there, i.e. the one split in two by a tiny platform. Stand and look south, using the binoculars or a flare to light up the path -- a dark alcove shows up! It contains a CROSSBOW, and Lara can flatfoot jump-n'-grab to get back to where she was before!

To exit the level, climb into the shaft the beam of light shines in, taking the west tunnel when it presents itself.

41) TEMPLE OF HORUS

[WK41]

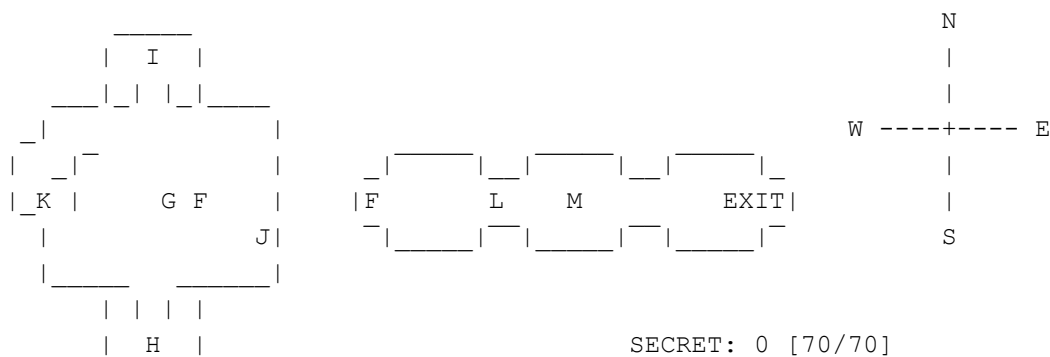

D	A: Water Puzzle #1
F	B: Connected Passage (Pole)
E	C: Water Puzzle #2
C	D: Connected Passage (Pole)
D	E: Water Puzzle #3
B	F: Connected Ps. (Lightbeam Shaft)
B	G: Armor of Horus
A	H: South Gate Switch
B	I: North Gate Switch
START	J: SE Corner (Climb Course Start)
	K: Crawlspace
	L: Sliding Pillar Trap
	M: Falling Pillar Trap

Lara starts the level in a passage with fountains. Pick up a LARGE WATERSKIN sitting on the floor, which is a 5-liter companion piece to the smaller one from 'The Mastabas' level which carries 3 liters. Here's how to do this:

- 1) Empty the smallest waterskin (select 'Use')
- 2) Fill up the largest waterskin
- 3) Combine the large waterskin with the empty waterskin
- 4) The Large Waterskin should have 2 liters, the smaller one 3.

At the scales, pour the Large Waterskin into the vase (a watery SFX plays if done right) and by balancing the thing, a floor grate opens. Kill a few bats

in the room beyond, which contains a pole. Save and jump to it, then inch downwards until Lara's right above the retractable spikes. As they're going back into their holes, slide down! Kill the bats when at the bottom.

The next room leads to another water puzzle! This one requires 4 liters, so naturally only the big one can fill it.

- 1) Make both waterskins empty
- 2) Fill the large waterskin
- 3) Combine it with the small waterskin
- 4) Empty the small waterskin
- 5) Combine the large waterskin with small waterskin
- 6) Fill the large waterskin
- 7) Combine large waterskin with small waterskin

This makes the small one at full capacity and the large at 4 liters. Put the latter into the scale's vase to open another floor grate! This leads to a similar setup, with a bat-filled room and pole with retractable spikes. The third and final water puzzle requires a single (1) liter! To make that a reality...

- 1) Empty both waterskins
- 2) Fill the small waterskin and combine it with the larger one
- 3) Repeat step #2

Bingo-bango! The floor grate that opens leads to a shaft of light room from the previous level. Either way, the first floor down has a locked gate and can't be used. Keep descending on the "rock" ladder wall until it runs out of space, then round the corner of part of the ceiling block. Lara may get 'stuck', so quickly let go and reattach, climbing up onto it. This should start a small panoramic cutscene.

#### HORUS' ARMOR

From the top of the cavern, (save and) do a running jump off into the water. The side shouldn't matter but low-hanging ceiling portions can put a damper on the attempt -- north works as long as you look for a ceiling groove that gives leeway. Anywho, get to Horus' armor and put the four 'Holy Scripture's on the pedestals around there. Approach the armor from the front and...

Dagnabit, things have gone awry and the Amulet was thrown into the water. It's on the north side, and easily accessible from the start. Avoid Set's projectile blasts (which can't work underwater; what a loser!) and collect the artifact, which opens a gate on the south side. To get to that door, a surfacing point in the SE corner gets up there. UZI AMMO is behind the door, and the switch opens the north gate.

Get there lickety split. A SMALL MEDIPACK is behind the door, and the switch activates some mechanism (?) in the shaft of blue light. Remember the floor with the gate that we skipped? It's there. A new ledge on a wall has extended but Lara isn't informed of this.

To find it, go to the southern door ramp and instead of going inside, jump to the SE corner. The ledge is on the east wall, within a running jump-n'-grab distance. Keep doing these until reaching the NE corner, which can be climbed a bit to find a SMALL MEDIPACK. Turn south again and there will be another ledge a running jump-n'-grab can get. From there, save and jump SE, aiming between the huge stalactite and the wall; if done right, Lara should barely land past a slanted ledge and on flat ground. This ledge has a crawlspace in plain sight by jumping west. Pull up into there and Set's wrath won't be

able to reach her. Out the other side, continue to a ledge that is right alongside the giant beam of light. Catch the climbable wall (Set will get in some attacks) and climb up the shaft. Automatically, Lara seals the cave and Set forever...?

ESCAPING THE GREAT PYRAMID

Anyway, the locked gate here will now be open. Continue past the sliding pillars trap and to an abyss where a rumbling is found. A pillar will fall from the ceiling onto the worn-out space in the middle, so stay clear of it! Slide down towards the abyss and jump at the last second, catching the other side. When a rumbling comes hide in the middle of the twin paths to avoid any untimely accidents. Slide down the next pit and jump like before, then hurry to the lip of the 3rd pit to avoid more falling pillars.

Hurry to the exit for a cutscene with a huge cliffhanger. Scarrrrr~y!

```

_____|
\__  __/|\      /|(  ___ \  (  ___ \|(  /|(  ___ \ (  )
) (  | )  ( || (  ___ \| | (  ___ \| | \ ( || (  \ ) ||
| | | (___) || (  ___ | (  ___ | \ | || | ) || |
| | | ___ || ___) | ___) | (\ \) || | | || |
| | | (  ) || (  ___ | (  ___ | | \  || | ) | ( )
| | | )  ( || (___/\ | (___/\| ) \ || (___/ ) _
)_ (  | /      \|(_____/ (_____/|/  )_)(_____/ ( )

```

Sadly, after the credits the main title is returned to. No infinite ammo is obtained (like in Tomb Raider 1) or anything. Shame...

---

/ IV. APPENDICES [APND] | \_

---

SECRETS

[SCRT]

From time immemorial, Tomb Raider games have contained "secrets," niches and alcoves tucked away from the main path and always carrying item rewards of some kind. Most carry ammunition but every once in awhile a weapon is found. There is no reward for finding all (70) secrets in the game but there's some satisfaction in doing it, considering how hard most are to find.

Secrets are listed in the order of appearance; just keep in mind that some levels have to be revisited to claim the prizes. Here's a general list of the per-level amounts and totals:

LV	LEVEL NAME	SECRET#
01	Angkor Wat	08 [08]
02	Race for the Iris	00 [08]
03	The Tomb of Seth	05 [13] - Missed 1
04	Burial Chambers	05 [18]
05	Valley of the Kings	03 [21]
06	KV5	04 [25]
07	Temple of Karnak	04 [29]
08	The Great Hypostyle Hall	00 [29]
09	Sacred Lake (Part 2)	01 [30]
10	Tomb of Semerkhet	07 [37] - Missed 1
11	Guardian of Semerkhet	03 [40]
12	Desert Railroad	03 [43]
13	Alexandria	01 [44]
14	Coastal Ruins	00 [44]

15   Catacombs	04 [48]
16   Temple of Poseidon	01 [49]
17   The Lost Library	03 [52]
18   Hall of Demetrius	00 [52]
19   Coastal Ruins	01 [53]
20   Pharos, Temple of Isis	00 [53]
21   Cleopatra's Palaces	01 [54]
22   City of the Dead	01 [55]
23   Chambers of Talun	02 [57]
24   Citadel Gate	01 [58]
25   Trenches	00 [58]
26   City of the Dead (Part 2)	01 [59]
27   Street Bazaar	01 [60]
28   Citadel	02 [62]
29   The Sphinx Complex	01 [63]
30   Underneath the Sphinx	01 [64]
31   Menkaure's Pyramid	01 [65]
32   Inside Menkaure's Pyramid	01 [66]
33   The Mastabas	01 [67]
34   The Great Pyramid	01 [68]
35   Khufu's Queens Pyramids	01 [69]
36   Inside the Great Pyramid	01 [70]
37   Temple of Horus	00 [70]
____   _____	_____

---



---

#### ANGKOR WAT

NOTE: All secrets in this level are golden skulls.

01   Start of the level, on a ledge near where Werner stands	
02   First jumping tutorial room, in the waist-deep water	
03   Second jumping tutorial room, lower area near a manmade waterfall	
04   Swimming tutorial room, at bottom of pool	
05   Outdoor area with two wild boars; SW corner, kittie-corner to exit	
06   In room with already activated spike traps, a li'l ways past #5	
07   When Lara has to crawl in small vent, in a dead-end offshoot	
08   After #7, in Virtuous/Heretical pathsplit area (SW corner)	
____   _____	_____

---



---

#### THE TOMB OF SETH

09   At the start, there's a path the guide walks and a darkened one that he doesn't because there's no torches. Kill the mangy dog around the area and find a climbable block in that dark passage, then angle the camera to locate an alcove within jumping distance. [SMALL MEDIPACK]	
-----+-----	
10   After #09, the guide waits in a locked door room w/ alcove switches. Ignore the switches and take the side passage, jumping down into the sand to find an alcove. This gets covered in sand via the switches, so it has to be done in this order. [SHOTGUN SHELLS]	
-----+-----	
11   In the room with a rope dangling from the ceiling, use it to jump to the west alcove. The secret plays by getting there, so getting the Uzi is NOT a part of the task!	
-----+-----	
12   In the sphinx room, use the ladder in the SW corner to reach a ledge	

| at around face height. Jump to the shoulder of its headdress and see  
| there is barely enough room to get to its frontal headdress. From  
| there, jump to its northern shoulder and find the alcove with items!  
[SHOTGUN SHELLS, LARGE MEDIPACK]
13
with a lever on it. Pull it and descend the ladder to find items now
uncaged! [SHOTGUN SHELLS, WIDESHOT AMMO]

---

---

#### BURIAL CHAMBERS

---

| 14 | The level starts with a sliding portion. SAVE first and wait until  
| part of the slope lightens (red) a bit, also when the ceiling opens  
up a bit. Jump-n'-catch the ledge for the cache. [LARGE MEDIPACK]
15
Lara has to pick one to evade the spike trap. Take the left one as
it leads to the secret. [SHOTGUN SHELLS]
-----  
| 16 | In the burial chamber of Seth, where Lara can get the Amulet of  
| Horus, an adjacent passage leads to a room with four sarcophagi in  
| upright positions. The NW corner has a secret passage that leads  
| under the room to the secret, but know that the secret is locked if  
the Amulet of Horus is obtained! [SMALL MEDIPACK, SHOTGUN SHELLS]
17
natural staircase that runs parallel to the south side of the room.
Hug that southern wall until part of it drops off into a pit, which
is where the secret is. [LARGE MEDIPACK]
-----  
| 18 | Upon reaching the octagonal room that spins, or after spinning it  
| twice which resets it to its natural position, jump from the initial  
| alcove (blindjump almost) to the ledge nearest the [LARGE MEDIPACK]  
| easily visible. A running jump is necessary to get up in there.  
|

---

---

#### VALLEY OF THE KINGS

---

| 19 | After clearing the ambush at the level's start, scour the southeast  
corner for a dark alcove. [2x SHOTGUN SHELLS, SHOTGUN]
20
it. However, the ledge that leads up to there can provide access to
the reddish rock wall/pillar outside the door (flatfoot jump?). In
any case, once one gets on the pillar, it leads up to the building's
roof. [UZI AMMO, SMALL MEDIPACK, 2x SHOTGUN SHELLS]
-----  
| 21 | Later, the road will have a large spike pit -- this is located near  
| the first overarching cliff bridge. Do a backwards jump-and-grab on  
| the pit's lip (near the ramp) to see the inside is notched and very  
| climbable. Maneuver to the thin slit under the ramp and pull up; at  
| the other end is the items. Note that it's sometimes hard to emerge  
| through the slit, so grab its ledge, release the action button and

| | press it quickly -- this lets Lara get a foothold and getting in is  
| | then possible. [SMALL MEDIPACK, GRENADE GUN SUPER AMMO]

---

---

KV5

---

---

| 22 | In the desert area with the first spike pit and scaffolding uziman,  
| | there will be a small crawlspace near the exit, cut out of the west  
| | rockwall. [LARGE MEDIPACK]

-----+-----  
| 23 | In the T-shaped junction between two buildings, the southern one has  
| | a secret bounty underneath its walkway. To claim it, pull up to the  
| | mid-level walkway and look for a drop-down point past a henchman.  
| | [SMALL MEDIPACK, LARGE MEDIPACK]

-----+-----  
| 24 | After unlocking the gate, there will be an incline with a trap that  
| | drops spikeballs toward the vehicle. Reach the top to stop the trap,  
| | then disembark and inspect the ceiling near the ramp's peak to find  
| | a recess. Face east and try to jump-n'-catch a ledge, although it's  
| | rather hard to get the right footing. [GRENADE GUN NORMAL AMMO]

-----+-----  
| 25 | Past the spikeball incline area, there will be a bend in the path by  
| | two spike pits, one small and the other L-shaped with its inner wall  
| | notched and climbable. Descend down it to find a half-hidden alcove  
| | that can be pulled up into. Like before, grab the lip, let go, and  
| | then immediately catch it again to be able to enter. [WIDESHOT AMMO,  
| | CROSSBOW NORMAL AMMO]

---

---

TEMPLE OF KARNAK

---

---

| 26 | In the beginning, near the obelisk plaza, find the SW corner of the  
| | area amidst some old arches and debris. There will be a pit there,  
| | and it leads to a crawlspace with lots of treasures, some of which  
| | are in breakables. [SHOTGUN SHELLS, LARGE MEDIPACK, WIDESHOT AMMO,  
| | UZI AMMO and FLARES]

-----+-----  
| 27 | From the obelisk plaza, go due west until reaching a pool of water.  
| | Swim down the shaft and take the side passage to a door -- this can  
| | be opened by pressing Action in front of it. Continue along until a  
| | small surfacing point is found. [CROSSBOW NORMAL AMMO, UZI AMMO]

-----+-----  
| 28 | Near #27, continue down the passage until it turns east. At that  
| | time, look west to find a triangular crack in the wall that gives  
| | barely enough clearance for Lara to get into a dark alcove with the  
| | treasures. [WIDESHOT AMMO, CROSSBOW POISON AMMO, LARGE MEDIPACK, UZI  
| | AMMO]

-----+-----  
| 29 | From the obelisk plaza, visit the northern building's interior -- it  
| | has two empty pools flanking a stairway. On the west red wall, spy a  
| | high-up crawlspace that leads to items. [FLARES, 2x UZI AMMO]

---

---



30 | After unlocking all doors at the obelisk via the Sun Talisman, take  
 | the south exit to find a pole leading down to water. One of the tiny  
 | crawlspace-sized tunnels leads to a gray door, and beyond that, the  
 | secret in a surfacing point. [WIDESHOT AMMO, CROSSBOW EXPLOSIVE AMMO  
 | and a LARGE MEDIPACK]

## TOMB OF SEMERKHET

Secrets 33-37 are available only if Lara loses Senet!

31 | After dropping into the chamber with a life-size Senet board, there  
 | will be some ledges on one side that lead to a black ladder, which  
 | points to the secret. [WIDESHOT AMMO, SMALL MEDIPACK]

32 | In the room with 3 blocks that shoot fire, after the scaffolding has  
 | be raised, Lara can get to a 2F ledge in the middle of the room with  
 | a single fiery-jet block. The east side of this platform has notched  
 | surfaces, letting Lara climb on it. Once she does, shimmy around the  
 | corner to the alcove. [WIDESHOT AMMO, LARGE MEDIPACK]

33 | When Lara loses the senet match, trapdoors in the floor around the  
 | game board activate. Take the NW hole and slide down three slopes,  
 | then jump-n'-grab off that last (3rd) one to catch a ledge. There's  
 | a pole that leads to the treasures. [SMALL MEDIPACK, WIDESHOT AMMO]

34 | In the room with two ropes hanging from the ceiling, use the nearest  
 | to land on a ledge with a closed red door (this ledge is over the  
 | Ba Cartouche door, as Lara finds out later). Push it open and take  
 | the prizes. [SMALL MEDIPACK, CROSSBOW EXPLOSIVE AMMO]

35 | After unlocking the Ra Cartouche door, there will be a room with 3  
 | ropes and a fire elemental. Get rid of the elemental by releasing an  
 | ice elemental nearby, then swing straight across all three ropes to  
 | find the secret alcove. [GRENADE GUN NORMAL AMMO, UZI AMMO, REVOLVER  
 | AMMO]

36 | Using the third rope in the Secret #35 way, swing east to another 2F  
 | platform that leads to a pole. Climb the pole, jump to the platform  
 | level right above it (3.5F?) and look for a black wall switch on one  
 | side. Jump to and pull it, which raises an odd platform at the level  
 | right above. Climb back up via the pole and jump to it, and take the  
 | torch from the wall mechanism now available. Throw the torch down to  
 | ground level and get down there yourself, then take the torch to the  
 | 3-rope room and light it. There are two unlit torches on either side  
 | of the pole room, and when lit, open a trapdoor in the main walkway.  
 | Go down, get through the circular scythe trap, and take the bounty  
 | before the room starts to fill with scarabs from the ceiling/floor.  
 | [WIDESHOT AMMO, LARGE MEDIPACK, FLARES, GRENADE GUN FLASH AMMO]

37 | Using the same technique in #36 to get to the height where the torch  
 | is obtained, use the walkway platforms on the opposite side of the  
 | room to find a passage with a ceiling access point. There's another  
 | black wall switch that raises scaffolding there, giving access to a  
 | passage that leads to the level's exit. Before going all the way, be

| | sure to search the ceiling thoroughly to find another access point... |  
| | [UZI, CROSSBOW EXPLOSIVE AMMO, LARGE MEDIPACK] |  
| |

---

---

#### GUARDIAN OF SEMERKHET

---

38	Use the Guardian Key and slide down into a lower hallway. At an east
	corner, Lara can get access to the notched ceiling lining everywhere
	around. Swing west, past the entrance point, and find a crawlspace's
	lip that can be dropped-n'-caught. This leads to a room with flaming
	blocks (not mentioned here) and the items sitting on decorations.
	[SHOTGUN SHELLS, CROSSBOW EXPLOSIVE AMMO]

-----+-----  
39	After making the guardian come out and play, follow the corridor it
	emerged from until a dead-end room is visited. The wall niche gives
	Lara a torch, which she can light back near where the guardian had
	emerged. Backtrack to the dead-end room, light both the torches here
	and voila! -- a secret door opens on the east side. The pedestals
	that hold the items are booby-trapped and avoid the center of the
	room, since another trap falls in from the ceiling! [SHOTGUN SHELLS,
	LARGE MEDIPACK, CROSSBOW NORMAL AMMO]

-----+-----  
40	Once the guardian is baited into the "Eye Mural Room", and Lara gets
	on the 2F walkway, inspect the southern side by the walkway's curve
	to find an open ceiling that's beggin' to be explored. The pedestals
	within aren't boobytrapped but there are two ceiling spikeballs that
	descend, before and after taking the item. Speaking of which, of the
	3 items in view, only one can be taken; the others catch on fire!
	[SHOTGUN SHELLS or SMALL MEDIPACK or LARGE MEDIPACK]

---

---

#### DESERT RAILROAD

---

41	At the final car ('caboose'), kill the assassin who climbs up and
	hang off the back end; a door opens and Lara can drop-n'-catch the
	lower crate's ledge. [REVOLVER AMMO, LARGE MEDIPACK, CROSSBOW NORMAL
	AMMO]

-----+-----  
42	In a boxcar right before the steep tarp-covered cargo, one of the
	crate panels can be peeled back to reveal the rest of the freight...
	[GRENADE GUN, GRENADE GUN SUPER AMMO, GRENADE GUN FLASH AMMO]

-----+-----  
| 43 | In the car Lara first started in (with a broken lever), one of the |  
| | crates can be pryed back to reveal an interior. [SMALL MEDIPACK] |  
| |

---

---

#### ALEXANDRIA

---

44	Walk on Jean-Yves' study's balcony and kill the two thugs on the
	warehouse roof to the west. Do a running jump to the building north
	of there and catch its roof. Shimmy to the east anterior and do a

| drop-n'-grab on the wall lever below. This opens a secret passage in  
| that same building. [LARGE MEDIPACK, CROSSBOW NORMAL AMMO]

---

---

### CATACOMBS

---

| 45 | In the room with two ropes hanging from the ceiling, make it to the  
| 2nd one and jump to the western crawlspace, which is above the niche  
| with a secret. There is only two chances to get this, once at the  
| start and once after getting the two Trident pieces in the southern  
| portion when the room is revisited. [SHOTGUN, FLARES, LARGE MEDIPACK]

-----+-----  
| 46 | In the room with the (4th, if you follow my walkthrough) Trident  
| piece high above the room with three levels of ledges, there are a  
| few white pieces of bone sitting around. Crossbow-snipe these (x5)  
| to make a trapdoor activate near the Trident pedestal. [CROSSBOW  
| EXPLOSIVE AMMO]

-----+-----  
| 47 | If #46 is obtained, this opens a brown SW door in the room with 3  
| tiers of walkways, top-level. [CROSSBOW EXPLOSIVE AMMO, WIDESHOT  
| AMMO, SHOTGUN SHELLS, LARGE MEDIPACK]

-----+-----  
| 48 | After collecting all four Trident pieces, get to the ground floor of  
| the three-tier walkway room and head to the northern dead-end shaft.  
| An elevator rises to a room above. [LARGE MEDIPACK, WIDESHOT AMMO,  
| CROSSBOW EXPLOSIVE AMMO]

---

---

### TEMPLE OF POSEIDON

---

| 49 | Most of the level relates to a large room with four exits, abyss in  
| the very center. The northern passage leads to a room with a couple  
| skeletons right off the bat. Jump into the lower middle portion and  
| check the SW corner crawlspace. [CROSSBOW NORMAL AMMO and a SMALL  
| MEDIPACK]

---

---

### THE LOST LIBRARY

---

NOTE: Apparently if you miss Secret #52 the first  
time, it can't be gotten, even though that room's  
available. I tried it myself to confirm -- seems so.

| 50 | Enter the NW of the six 1F doors. After a straightforward path, Lara  
| will be in a room with a gigantic rotating cog and some tinmen to  
| dispose of. The cog is over a pit but upon closer inspection, a tiny  
| ladder is on one side. Descend deeper and deeper to find the secret.  
| [SMALL MEDIPACK, REVOLVER AMMO, UZI AMMO]

-----+-----  
| 51 | After obtaining the Horseman's Gem, in that same room, move to the  
| south and look for a weird gate high up on the wall. Combine the bow  
| with the LaserSight (from the Alexandria level) and snipe the pulley  
| object high up towards the ceiling. This releases the gate, letting  
| Lara climb in! [LARGE MEDIPACK, SHOTGUN SHELLS, UZI AMMO]

52	Upon reaching the main room's balcony (2F), enter the SWmost door --
	it has a ramp underneath a trapdoor. Save first, slide down, jump at
	the ladder right before Lara flies out the statue's mouth. Climb up
	and jump to the south wall ledge. [CROSSBOW NORMAL AMMO, LARGE
	MEDIPACK]

---

---

HALL OF DEMETRIUS

---

---

53	Although technically in the Coastal Ruins area, this secret's gained
	automatically after exiting Hall of Demetrius, which involves being
	dropped through a ramp and landing in some water.

---

---

CLEOPATRA'S PALACES      NOTE: There is a glitch for triggering spikefloor traps  
(some, anyway) without being instantly killed. If the  
scarab toy breaks, I suggest looking this method up...

---

---

54	After combining to make the 'Mechanical Scarab with Key,' which has
	three (3) uses before it breaks, use it to spring the 1st spikefloor
	boobytrap. Continue along until finding a single boobytrap of this
	same nature (if you come across two of these in a row, you've gone
	the wrong way) and proceed. In one of the rooms, a harpy appears;
	take the NE passage until coming to a path with 3 exits: 2 spiketraps
	and one needing an artifact to open. The north passage is the way to
	go for the bounty. [4x SHOTGUN SHELLS, WIDESHOT AMMO, SMALL MEDIPACK
	EXPLOSIVE CROSSBOW AMMO]

---

---

CITY OF THE DEAD

---

---

55	Part of mandatory play is opening the iron gate near the start in
	order to drive the motorcycle to a building and get rooftop access.
	En route to this, Lara must freeze a small pond to get to a lever;
	this opens a door to a room near a soldier's corpse. Upstairs from
	here is a crowbarrable door that has the secret. [LARGE MEDIPACK]

---

---

CHAMBERS OF TALUN

---

---

56	After climbing to the top level of the building near the start, jump
	to the west perch and swing to the east space, which is guarded by
	two stag beetles. [LARGE MEDIPACK, WIDESHOT AMMO]

---

---

57	On the north side of the fortress, over the tunnel that leads to the
	Trenches level, use the raised earth to grab the slanted awning and
	locate a flat portion that leads to a crawlspace. [LARGE MEDIPACK,
	FLARES, CROSSBOW POISON AMMO, REVOLVER AMMO]

---

---

CITADEL GATE

---

| 58 | Past the dragon, in the area with caskets and switches, a rope can  
| | be accessed from the 2F balcony (with some annoyances). Do a running  
| | jump to it, then look NE at the bell in that area. With momentum it  
| | is possible to jump to that alcove, then drop-n'-grab to the crawl-  
| | -space underneath it. [LARGE MEDIPACK, CROSSBOW EXPLOSIVE AMMO]

---

---

---

CITY OF THE DEAD (PART 2)

---

| 59 | This can only be done after making the Nitrous Oxide Feeder from the  
| | Nitrous Oxide Canister (in Citadel Gate) and Valve Pipe (Trenches).  
| | The western street near where the rooftop machinegun turrets were'll  
| | lead to a large pit that can be crossed with the nitro's boost. Kill  
| | the soldier and locate four slanted, pinkish pillars. Pull up on the  
| | southern one (center Lara), then hold the jump button -- Miss Croft  
| | will complete the tricky jump slopes and land on the eastern ledge  
| | overlooking the secrets, if all goes right. [GRENADE GUN SUPER AMMO,  
| | CROSSBOW EXPLOSIVE AMMO, LARGE MEDIPACK]

---

---

---

STREET BAZAAR

---

| 60 | After using the rooftop lightning rod to blow up part of a bridge,  
| | do a running jump off said bridge to catch the notched exterior of  
| | the building. Shimmy around the corner to stable ground, then peer  
| | NE to the greenish-hued path. A running jump can clear the slanted  
| | portion, leading to the locust-infested secret. [LARGE MEDIPACK,  
| | GRENADE GUN FLASH AMMO, CROSSBOW POISON AMMO]

---

---

---

CITADEL

---

| 61 | In the multi-story room with a thug-guarded lever at the top, the  
| | west side has a broken stairway over a watery shaft. Above there's a  
| | notched ceiling Lara can climb on. Swing to the south wall, execute  
| | a drop-n'-grab on the crawlspace lip. [GRENADE GUN FLASH AMMO, LARGE  
| | MEDIPACK]

-----  
| 62 | After the first area with undead knights, Lara is in a room with a  
| | deep shaft in the west corner of a depression. Hang on the inner rim  
| | then drop-n'-grab the crawlspace on the south side. This leads to a  
| | steep-looking but traversable hill that gives access to a higher  
| | room guarded by two more knights. [WIDESHOT AMMO, GRENADE GUN FLASH  
| | AMMO, CROSSBOW EXPLOSIVE AMMO, LARGE MEDIPACK, REVOLVER AMMO]

---

---

---

## THE SPHINX COMPLEX

---

63	In the supply room with the Metal Blade, there are two shelves next to each other. Push them both north to reveal the prize underneath one. [SHOTGUN]
----	---

---

---

## UNDERNEATH THE SPHINX

---

64	In the northwest room that has three crawlspaces, take the east one which leads to a bifurcation. The south path has a feeble trapdoor that normally leads to spikes; however, this one crumbles to reveal a secret item. [GRENADE GUN]
----	---

---

---

MENKAURE'S PYRAMID

NOTE: Lara needs to get the Armory Key in this level to find a future secret. To obtain, when she encounters a guard fighting a scorpion, save the guard (kill scorp).

---

65	After climbing up Menkaure's Pyramid and finding the door that 'The Guards Keys' opens, unlock it but don't go in. Instead, there's a second climbing path that starts in the SE and arcs back west a bit, giving access to some items on top of the stone door frame. [SMALL MEDIPACK, REVOLVER] The secret registers after taking the Revolver.
----	---

---

---

## INSIDE MENKAURE'S PYRAMID

---

66	After finding a chain past some blade-n'-spikepit traps, it opens a portcullis in a sloped cavern. Save at the top and start the slide, jumping to the right (SW) towards the bottom, landing in the safe part of the spike pit or a ledge right near there. [UZI]
----	--

---

---

## THE MASTABAS

---

67	At the beginning, in the area near the gas station, a building is boarded-up and has a "do not enter" sign. Bust inside and look for a well-camouflaged trapdoor that leads to the secret. [LARGE MEDIPACK]
----	---

---

---

## THE GREAT PYRAMID

---

68	Towards the start of the level, in the first mastaba where Lara has
----	---

| | to enter via a door, there will be a camouflaged trapdoor that leads |  
| | down to the secret. [GRENADE GUN] |  
|\_\_\_\_\_|

---

---

## KHUFU'S QUEENS PYRAMIDS

---

---

69	Towards the start of the level are two doors at a pyramid's base,
	the westmost of which leading to an armory with items inside boxes.
	This can only be unlocked with an Armory Key obtained in "Menkaure's
	Pyramid" level, by saving the guard who was harassed by a scorpion.
	[CROSSBOW POISON AMMO, SHOTGUN, UZI, CROSSBOW, GRENADE GUN, REVOLVER
	and WIDESHOT AMMO]
\_\_\_\_\_	

---

---

## INSIDE THE GREAT PYRAMID

---

---

70	The starting hallway that points north is plagued with many abysses,
	but in one (the 3rd from north, AKA the one split in two by a tiny
	platform) the secret is hidden. From the north, peer south and look
	with a flare/binoculars flashlight to uncover an alcove in the dark.
	[CROSSBOW]
\_\_\_\_\_	

---

---

## ENEMIES

[ENMS]

---

---

Enemies come in all shapes in sizes, from the lowly beetle-bug to the large invincible monster who wants to eat Lara's face. Aggressive monsters are listed here (no bosses) and so are passive (boobytrap) enemies that lie in wait.

---

## SPIKES

First Found: Almost every level

Good ol' reliable spikes. This type is a passive trap, relying on human error instead of other factors. They often sit at bottoms of holes (punji-pit-like) and wait for missteps or misjumps to impale the target. Careful planning and knowing the area's layouts help, but saving beforehand is a great teacher as well. Later, in Cleopatra's Palaces, the only way to proceed (legitimately) is to use the Mechanical Scarab with Key which springs the trap for her.

---

## MANGY DOGS

First Found: The Tomb of Seth

These fleabagged mutts are probably ugly wolves, but y'wouldn't know it from how easy they are to take down. They appear a few times in the level but pose little threat unless Lara was previously injured. Pistols give feed them the daily dose of lead with ease.

---

## SCORPIONS

---

First Found: The Tomb of Seth

C'MERE! These reddish stinger fiends usually appear in two ways: pits they can't climb out of or are triggered by some event in a room they can't climb out of. Pistolwork perforates their carapace pretty easily and they're on the lower rungs of the difficulty ladder.

#### ROLLING SPIKE MACHINE

First Found: The Tomb of Seth

To get the uzi on the first level, Lara has to outsmart the spike machine rolling on wall grooves in one of the passages. It doesn't kill Lara in an instant like some other traps, but it heavily damages her. Avoiding is as simple as knowing where it is which, unlike traps to follow, is harder since it runs rather silently.

#### SWORD TRAP

First Found: The Tomb of Seth

This trap has blades on the ceiling and floor, and will mince whoever happens to meander inside without proper knowledge. Lara's guide deactivates the trap when he comes to it, so unless Lara's go-get-'em attitude gets her sliced in fine strips, there's little reason this should kill her.

#### FIERY OIL POOLS

First Found: The Tomb of Seth

Once calm and harmless, the tour guide will set fire to these pools to make some light. If Lara jumps in, she catches on fire and dies -- simple as! Just avoid them and things'll be hunky dory.

#### ASTERISM SPIKE TRAP

First Found: Burial Chambers

An asterism is a cluster of stars, and the holes the spikes come out of are shaped like stars -- I know, great term for the thing! This trap may encircle a room or come out of a block, but no matter where it shows up, it's often easy to spot for two reasons: visual identification and the horrible grinding noise they make when approached. They emerge and recede at regular intervals, so they're not as hard as they appear.

#### SPINSCYTHE TRAP

First Found: Burial Chambers

Sometimes paired with asterisms spike traps, this trap won't kill Lara in one go but is designed to keep her in constant motion which increases the chance of error (or it knocking her off platform). The blades can be jumped over but it's still annoying, even if one knows the correct path to go.

#### MUMMIES

First Found: Burial Chambers

The stereotypical pyramid/burial chamber/sarcophagi enemy, this time mummies



are invincible, despite their desiccated, rotted state of existence. They're slow-moving and often don't attack without provocation, meaning Lara's safe to do puzzles and whatnot until she puts one square 'tween their eyes. Easy to avoid, generally.

#### FANCY DOGS

First Found: Burial Chambers

Kinda like the mangy dogs from previous levels, these ones wear gold jewelry and are a little tougher, even though the pistols can still take 'em out with little to no trouble.

#### HENCHMEN

First Found: Valley of the Kings

These uzi-totin' wannabe punks ambush Lara for their first appearance and continue to pester her throughout the game. They're dressed in desert garb and only fire their weapons in bursts, which gives Lara more than enough time to beat them into submission.

#### ENEMY VEHICLE

First Found: Valley of the Kings

This white van isn't for soccer moms -- it's driven by a henchman and drops grenades out its backdoor, which can damage Lara if her driving's erratic. Since the grenades drop in line with the vehicle's movement, evading them and the explosions isn't so hard. The van is 'invincible' for all intents & purposes.

#### BLACK SCORPION

First Found: Temple of Karnak

These suckers are just like normal scorpions except their stings can 'poison' Lara, the effect of which constantly lowers her healthbar and, after awhile, gives a hazy LSD trip effect where the world distorts and her vision blurs. Using a medipack cures this condition, and these scorps are barely better than their worst counterparts in terms of constitution...meaning use pistols!

#### BATS

First Found: Sacred Lake

Bats are small and agile, but have little defense -- even pistols can take 'em out without any trouble. In previous games these have appeared earlier...

#### CROCODILE

First Found: Sacred Lake

These reptilian wonders are surprisingly fast on land and have enormous health to deplete. That's why the pistol should be switched to the shotgun, which can two-shot the suckers before they make a Happy Meal out of Lara.

#### NINJA HENCHMAN

First Found: The Great Hypostyle Hall, Pt. II

These are like regular henchman in black and red. It carries a sword thingy and can deflect bullets, and keeps this stance until Lara puts some distance between her and them. A few shotgun blasts will take 'em down, though.

#### SCARAB SWARM

First Found: Tomb of Semerkhet

These dangerous bugs are invincible gameplay-wise, and will quickly devour Miss Croft's health if they catch up with her. She'll have to clamor to high ground or hang onto the ceiling to avoid their wrath, which impedes her a few times in the game. Torches keep the scarabs at bay to a minimal extent, but don't prevent damage.

#### FIRE/ICE ELEMENTAL

First Found: Tomb of Semerkhet

This fiery fiend flies through the air and pesters Lara with general damage, and can even catch her on fire! There are only two ways to kill one of these suckers: sic an ice elemental on its tail and let them negate each other, or lure it into water, where it fizzles out. [The Ice Elemental, when faced as or a cross-shaped statue, the latter which is used in the Catacombs level.]

#### CIRCULAR SCYTHE TRAP

First Found: Tomb of Semerkhet

This trap is like a circular ring with six or seven scythe pieces on it, that slice into the middle at regular intervals. Since it's stationary, Lara can get by by sprinting and diving through, or taking one for the team and just bungling through (with health loss). Note that standing really close and rolling past the blades when they're closed works as well, although isn't a good idea if, say, scarabs are following.

#### HIDDEN FLOOR-TILE BLADES

First Found: Guardian of Semerkhet

Long name, quick death. These first appear on the ground floor of the room with a timed cleaver trap. The blades are underground and when Lara steps on one, four blades come out of the corner and converge in the center, killing her instantly...or, rather, they have to catch her cleanly to OHKO. Still, it's best not to test out the specifics and simply avoid any weird tiles like that.

#### HIDDEN UNDER-PATH BLADES

First Found: Guardian of Semerkhet

These longsword-like blades point vertically down from certain paths, and when Lara steps haphazardly, they pull a full rotation and slide her up. They can be visually identified but are impassable unless a mechanism shuts them off or delays 'em.

#### PEDESTAL BLADES

First Found: Guardian of Semerkhet

Some pedestals are boobytrapped, so when an artifact is taken, four blades come up and cut downward at the enemy. These are a one-time affair and can be avoided by taking the item at an angle (NW, SW, SE, NE). The pedestals that fit this bill are also easily detected by long black slits down the cardinal directions' sides. [NOTE: Some blades only come out from certain sides, although the rest holds true.]

#### SPIKEBALL BOOBYTRAP

First Found: Guardian of Semerkhet

In one of the secrets, this thing falls down from the ceiling in the middle and after a moment, a bunch of blades poke out. It doesn't move around or have any special abilities, but if Lara happens to hit it, even when it's just sitting there, she bleeds out...so avoid!

#### GUARDIAN

First Found: Guardian of Semerkhet

This invincible guardian in the shape of a bull (I mistakenly call it a minotaur) is immune to conventional weapons, and all weapons for that matter. Whenever it appears, which is rarely in the ensuing levels, the only option is to run away and/or use it to open paths. Lara can bait it into charging like a novice matador, which comes in useful for breaking down doors and such.

#### SKELETONS

First Found: Coastal Ruins

These sword-wielding Halloween decorations are rather fun to fight. Like a few other enemies, they are invincible with regard to normal weapons. However if they are exploded they permanently die. The really fun way is to use the lasersight + crossbow to snipe their heads; when they have no head, they'll just run around and not attack Lara any longer. Another way to "get rid" of them is to use the knockback effects of weapons, pushing them into deep pits or places they can't climb out of.

#### BOULDER TRAP

First Found: Coastal Ruins

It's a simple setup: a pulley holds a boulder above a certain spot, and if Lara steps there, it falls (after a delay). To trigger it, simply step on that certain spot and back/sideflip away.

#### TINMEN

First Found: The Lost Library

Although perhaps not made of tin, these mechanized men carry axes and attack Lara without compunction. They're invincible to normal weapons from the sides or back, and it's only when Lara shoots the green gem on their chest that any real damage is done. They'll grunt when hurt, and that's the only way to tell! I recommend using a shotgun for the job.

#### POLE GEARS

First Found: The Lost Library

Although more of a nuisance than anything else, these gears rotate around poles and damage Lara if she touches them. Since backflipping off poles often requires her to be level with the floor/ceiling (relative), they can really take off chunks of her health. They're invincible, naturally, and the only way to get past is coordinated sliding or taking one for the team.

#### HARPY

First Found: Pharos, Temple of Isis

This "bird" has a human face and will fire projectiles at Lara, but really doesn't have any super-special traits to take note of. Dr. Uzi will cure all its living problems!

#### CLEOPATRA GUARDIAN

Found: Cleopatra's Palaces

Guarding the long-dead queen's throne room, these guardians shoot mystical blue projectiles and take a lot of bullets to be downed. If Lara stands at mid-range, for some reason the enemy's projectiles may zoom upward and miss her completely and giving an easy advantage. They also attack one at a time.

#### CAIRO SOLDIER

First Found: City of the Dead

These guys are tougher than normal grunts but don't have the capability to stop bullets like those fiery-red assassins in the Karnak levels, which means they aren't that useful. Their main feature is better firepower, and they'll commonly use grenade rounds. Also, Lara first gets her Revolver from one of these suckers.

#### AUTOMATED MACHINEGUN

First Found: City of the Dead

These suckers can raise a lot of hell if Lara comes into their line of fire, but since they're inert, they're helpless if she can get around back. The only way to destroy the guns is by shooting their white-ish canister with the revolver (which means attaching a LaserSight for better accuracy). Their most dangerous feature is the flamethrower at close-range -- this may be the best reason to snipe the weak spot from afar.

#### STAG BEETLE

First Found: Chambers of Talun

These overgrown bugs are as big as bats and twice as tough...meaning it takes two shotgun blasts instead of two. They pester Lara just like bats and also make a mind-numbing buzz noise -- that alone is worthy of death.

#### LOCUSTS

First Found: Citadel Gate

Another bug enemy! These pestilence-bringing, crop-failing, health-eating mongrels will often just appear around Lara out of nowhere, and drain her health without any counterattack. Running away seems to disperse them, and

that's really the only course of action to take, sadly.

#### DRAGON

First Found: Citadel Gate

This behemoth sits in a pit (inert) and shoots flaming projectiles on a set pattern. If Lara is hit, she catches fire and will probably die. Use cover to block the projectiles and sprint past when the opening is clear. It can't be damaged by conventional weapons.

#### UNDEAD KNIGHTS

First Found: Citadel

These reanimated corpses of Crusaders cannot be killed or damaged (where have we seen that before?). Slow-moving and kinda weak, they're only seen in one level. Yawn!

#### LATERAL SWORD TRAP

First Found: Underneath the Sphinx

Ever seen Indiana Jones and the Last Crusade? It has a trap like this, which swings laterally (horizontally) and damages Lara, if not outright killing the poor gal. Ducking under it will work; the downside is that it's found with boobytrapped floor traps which make this task rather difficult.

#### OVERGROWN SCORPION

First Found: Menkaure's Pyramid

The red scorpions of yesterdungeon have taken steroids and become these large freaks, with much more health. For instance, it takes three grenade rounds to take one down! However, unlike their similarly-colored smaller counterparts, these ones do have poisonous stings! That's evolution for ya.

#### BIRD GUARDIAN

First Found: Inside Menkaure's Pyramid

Like the jackal guardians from Cleopatra's Palaces, this foe also shoots energy projectiles, just at a faster rate. And, like the previous guardians, if Lara can get 'round back, it has to turn slowly and resume firing.

#### PYRAMID DEBRIS

First Found: The Great Pyramid

While scaling the outer face, sometimes the structure will shake and loose boulders will tumble down the side. If one hits Lara, it'll do more than make her see stars -- she'll be a stain! Avoiding them isn't too hard since there is no random factor to their appearance or where they land. Just to be on the safe side, crouching against cover helps.

#### SLIDING PILLAR TRAP

First Found: Inside the Great Pyramid

These pillars slide across paths, killing Lara if they hit. They're avoided

with some timed jumps, so save beforehand.

## DINOSAUR?

Found: Temple of Horus

If Lara messes up one of the water puzzles, a gate opens and this creepy monster crawls out. It crawls on all fours, has a dinosaur head, and looks like a crocodile in some way. It's not necessarily tough but it does respawn behind the gate, waiting for the next time Lara screw up the puzzle!

## FALLING PILLAR TRAP

Found: Temple of Horus

Toward the last leg of this area, a small rumbling will herald a pillar dropping in from the ceiling. It instantly kills Lara should it connect, but simply progressing forward or hiding off the main path evades its attack. It does block part of the path though, so dilly-dallying doesn't help.

---

---

## CHEATS

[CHTS]

---

---

Like most Tomb Raider games, there are push-button codes for those who just want to destroy stuff from the get-go. Before inputting the code, Lara must be pointing directly north. This can be done manually but most people prefer to hang from a flat object with a south face, which accomplishes this a lot easier. When that part is done, enter the menu and highlight a certain object listed below:

<u>EFFECT</u>	<u>MENU HIGHLIGHT</u>	<u>BUTTON COMBO (PRESS TOGETHER)</u>
ALL ITEMS	Large Medipack	R1 + R2 + L1 + L2 + Down
LEVEL SKIP	Load Option	R1 + R2 + L1 + L2 + Up
INFINITE AMMO/MEDIPACKS	Small Medipack	R1 + R2 + L1 + L2 + Up
ALL SPECIAL ITEMS/ARTIFACTS	Large Medipack	R1 + R2 + L1 + L2 + Down

Some overzealous people may think getting everything is great, but it's been known to cause serious game-breaking bugs, particularly ones regarding artifacts and other special items. Level-skipping can also cause players to permanently miss crucial items needed to complete future levels, which is why it's not advised, even if you know what you're doing.

In any event, use these with caution!

---

---

## V. FREQUENTLY ASKED QUESTIONS

[FAQZ]

[Q] - Hey! You said I get [ammo] here but I actually got the [ammo's weapon]!

[A] - Yeah, that sometimes happens. Sometimes if you've already obtained a weapon at that point, instead of getting another weapon (which turns into a bunch of ammo) you simply get a normal ammo cache.

[Q] - Lara's health is depleting and there's a weird acid trip effect! Help!

[A] - This occurs when she's been poisoned, such as by black scorpions. Her

life constantly worsens and after awhile, there's a hazy LSD effect as her vision blurs (which is really cool, actually). Using a medipack of any sort cures her condition back to normal.

[Q] - Why can't I pull up into this crawlspace?

[A] - This is a common problem that results from Lara not really 'grabbing' the lip from above, but rather the side (such as portions where she moves laterally to the crawlspace like in Valley of the Kings). To rectify, climb as high to the lip as possible, let go and quickly press action again. She should grab the lip like normal and that's how y'do it.

[Q] - In Chamber of Talun's main building, I can't round the 2F pillar corner!

[A] - I've noticed this too. Lara can do the first corner easily but the last one to get back on the west ledge is weird. On the 2nd face, make Lara climb up (so she has a foothold) and then try -- that should work.

[Q] - I entered a new level from [direction] and it says [new direction]!

[A] - I have no idea what this is about but it's happened to me too. For instance, after finishing "Khufu's Queens Pyramids" Lara exits to the east; when the level starts, east is displayed as 'north'. It's quite an annoyance to be sure but shouldn't affect much, since I usually check for the 'current' north at each level's beginning.

---

---

## VI. UPDATES & CONTRIBUTIONS

[UPDT]

---

---

07-09-06 -----+ Started walkthrough  
10-15-08 -----+ Scrapped old version and restarted walkthrough  
10-24-08 -----+ Finished walkthrough  
06-14-09 -----+ Updated Hall of Demetrius & Trenches sections

For errors and corrections, make sure to email me! I'm interested in that kind of stuff.

### THANKS TO...

- Sailor & Ceej, for always hosting my junk
- Nic Holte, for playing Tomb Raider games with me since way back when
- The readers, 'cause this was one heck of a fun thing to write, dagnabit!
- Boat, for some glitch/tips in Hall of Demetrius & Trenches
- kenzie.weisener, for info on possible Armory Key glitch
- E. Waldron, for missing medipack in 2nd Hypostyle Hall visit

---

---

## VII. LEGALITY

[LGLT]

---

---

This document is intended for private home use ONLY, and may not be reproduced through electronic or commercial means without the expressed consent of the author (Patrick Summers). It cannot be hosted, edited, or distributed for profit, and may not be given away as an add-in/gift to bought items. All rights are reserved to respective parties, even those not explicitly stated herein. Those who find thos document on sites not listed below should e-mail the author (Shotgunnova). Thanks for reading, and thanks for respectin' FAQers.

ALLOWED SITES

DISALLOWED SITES

- 
- Gametalk.com
  - GameFAQs.com
  - MyCheats.com
  - Neoseeker.com
  - GamesRadar.com
  - Supercheats.com
  - Honestgamers.com
  - Chaptercheats.com
  - Cavesofnarshe.com

- CheatCC.com

E-mail for permissions at:  
shotgunnova[[@](mailto:shotgunnova@gmail.com)]gmail.c0m

---

FACTS ALL COME WITH POINTS  
OF VIEW, FACTS DON'T DO  
WHAT I WANT THEM TO

Document © Shotgunnova 1997-2008 (and countin'!)  
Tomb Raider namesake © respective owners  
E N D O F D O C U M E N T

This document is copyright Shotgunnova and hosted by VGM with permission.